

Leica CS20 & GS07 Sensor



User Manual
Version 2.3
English

- when it has to be **right**

Leica
Geosystems

PART OF
HEXAGON

Introduction

Purchase

Congratulations on the purchase of the Leica CS20/GS07.



This manual contains important safety directions as well as instructions for setting up the product and operating it. Refer to [1 Safety Directions](#) for further information.

Read carefully through the User Manual before you switch on the product.



The content of this document is subject to change without prior notice. Ensure that the product is used in accordance with the latest version of this document.

Updated versions are available for download at the following Internet address:

<https://myworld.leica-geosystems.com> > myDownloads.

Product identification

The model and serial number of your product are indicated on the type plate. Always refer to this information when you need to contact your agency or Leica Geosystems authorised service centre.

Trademarks



- Windows is a registered trademark of Microsoft Corporation in the United States and other countries
- SD Logo is a trademark of SD-3C, LLC.
- *Bluetooth*[®] is a registered trademark of Bluetooth SIG, Inc.



All other trademarks are the property of their respective owners.

Validity of this manual

This manual applies to the CS20 field controller, the GS07 and the CTR20/CGR4 expansion packs. Differences between the various models are marked and described.

Available documentation

Name	Description/Format		
CS20 Quick Guide	Provides an overview of the product together with technical data and safety directions. Intended as a quick reference guide.	✓	✓
CS20 User Manual	All instructions required in order to operate the product to a basic level are contained in the User Manual. Provides an overview of the product together with technical data and safety directions.	-	✓

Name	Description/Format		
Leica Captivate Technical Reference Manual	Overall comprehensive guide to the product and apps. Included are detailed descriptions of special software/hardware settings and software/hardware functions intended for technical specialists.	-	✓

Refer to the following resources for all CS20 documentation/software:

- the Leica USB documentation card
- <https://myworld.leica-geosystems.com>

Leica Geosystems address book



On the last page of this manual, you can find the address of Leica Geosystems headquarters. For a list of regional contacts, please visit http://leica-geosystems.com/contact-us/sales_support.

myWorld@Leica Geosystems (<https://myworld.leica-geosystems.com>) offers a wide range of services, information and training material.

With direct access to myWorld, you are able to access all relevant services whenever it is convenient for you.

Service	Description
myProducts	Add all products that you and your company own and explore your world of Leica Geosystems: View detailed information on your products and update your products with the latest software and keep up-to-date with the latest documentation.
myService	View the current service status and full service history of your products in Leica Geosystems service centres. Access detailed information on the services performed and download your latest calibration certificates and service reports.
mySupport	Create new support requests for your products that will be answered by your local Leica Geosystems Support Team. View the complete history of your support requests and view detailed information on each request in case you want to refer to previous support requests.
myTraining	Enhance your product knowledge with Leica Geosystems Campus - Information, Knowledge, Training. Study the latest online training material on your products and register for seminars or courses in your country.
myTrustedServices	Add your subscriptions and manage users for Leica Geosystems Trusted Services, the secure software services, that assist you to optimise your workflow and increase your efficiency.

Table of Contents

1	Safety Directions	6
1.1	General Introduction	6
1.2	Definition of Use	7
1.3	Limits of Use	7
1.4	Responsibilities	7
1.5	Hazards of Use	8
1.6	Laser Classification	12
	1.6.1 General	12
	1.6.2 DISTO	13
1.7	Electromagnetic Compatibility (EMC)	14
1.8	FCC Statement, Applicable in U.S.	16
1.9	ISED Statements (EN/FR), Applicable in Canada	18
2	Description of the System	19
2.1	Overview	19
2.2	Terminology	19
2.3	System Concept	20
	2.3.1 Software Concept	20
	2.3.2 Power Concept	21
	2.3.3 Data Storage Concept	22
2.4	Container Contents	23
2.5	CS Components	26
2.6	GS07 Components	26
3	User Interface	27
3.1	Keyboard	27
3.2	Operating Principles	29
3.3	LED Indicators on CS20	29
3.4	LED Indicators on GS07	30
4	Operation	32
4.1	Equipment Setup	32
	4.1.1 Setting up as a Post-Processing Base	32
	4.1.2 Fixing the Field Controller to a Holder and Pole	33
	4.1.3 Fixing a Hand Strap to the CS	35
	4.1.4 Fixing the Utility Hook to the CS	35
	4.1.5 Replacing the Display Foil on the CS	36
	4.1.6 Inserting and Removing a SIM Card	37
	4.1.7 Setting Up for Remote Control or RTK using an Expansion Pack	37
	4.1.8 Connecting to a Personal Computer	38
	4.1.9 Enabling WLAN in Windows EC7	41
4.2	Batteries	41
	4.2.1 Operating Principles	41
	4.2.2 Changing the Battery	42
	4.2.3 Charging the Battery	43
4.3	Power Functions	44
4.4	Working with the Memory Device	45
	4.4.1 Working with the SD Card	45
	4.4.2 Working with a USB Memory Stick	46
4.5	Using the Digital Camera	46
4.6	Using the Camera Flash Light as Torch	47
5	Care and Transport	48
5.1	Transport	48
5.2	Storage	48

5.3	Cleaning and Drying	48
6	Technical Data	50
6.1	CS20	50
6.2	GS07	52
6.2.1	Tracking Characteristics	52
6.2.2	Accuracy	52
6.2.3	Technical Data	53
6.3	Conformity to National Regulations	54
6.3.1	Products without Radio	54
6.3.2	CS20	55
6.3.3	GS07	58
6.3.4	CTR20	59
6.3.5	CGR4	59
7	Software Licence Agreement/Warranty	61
Appendix A	Pin Assignments and Sockets	62
A.1	CS20	62
A.2	GS07	62

1 Safety Directions

1.1 General Introduction

Description

The following directions enable the person responsible for the product, and the person who actually uses the equipment, to anticipate and avoid operational hazards.

The person responsible for the product must ensure that all users understand these directions and adhere to them.

About warning messages





Warning messages are an essential part of the safety concept of the instrument. They appear wherever hazards or hazardous situations can occur.

Warning messages...

- make the user alert about direct and indirect hazards concerning the use of the product.
- contain general rules of behaviour.

For the users' safety, all safety instructions and safety messages shall be strictly observed and followed! Therefore, the manual must always be available to all persons performing any tasks described here.

DANGER, WARNING, CAUTION and **NOTICE** are standardised signal words for identifying levels of hazards and risks related to personal injury and property damage. For your safety, it is important to read and fully understand the following table with the different signal words and their definitions! Supplementary safety information symbols may be placed within a warning message as well as supplementary text.

Type	Description
 DANGER	Indicates an imminently hazardous situation which, if not avoided, will result in death or serious injury.
 WARNING	Indicates a potentially hazardous situation or an unintended use which, if not avoided, could result in death or serious injury.
 CAUTION	Indicates a potentially hazardous situation or an unintended use which, if not avoided, may result in minor or moderate injury.
NOTICE	Indicates a potentially hazardous situation or an unintended use which, if not avoided, may result in appreciable material, financial and environmental damage.
	Important paragraphs which must be adhered to in practice as they enable the product to be used in a technically correct and efficient manner.

1.2

Definition of Use

Intended use

- Remote control of product
- Data communication with external appliances
- Recording measurements
- Computing with software
- Carrying out measurement tasks using various GNSS measuring techniques
- Recording GNSS and point related data
- Measuring raw data and computing coordinates using carrier phase and code signal from GNSS satellites (GNSS systems)

Reasonably foreseeable misuse

- Use of the product without instruction.
- Use outside of the intended use and limits.
- Disabling safety systems.
- Removal of hazard notices.
- Opening the product using tools, for example screwdriver, unless this is permitted for certain functions.
- Modification or conversion of the product.
- Use after misappropriation.
- Use of products with recognisable damage or defects.
- Use with accessories from other manufacturers without the prior explicit approval of Leica Geosystems.
- Inadequate safeguards at the working site.
- Controlling of machines, moving objects or similar monitoring application without additional control and safety installations.

1.3

Limits of Use

Environment

Suitable for use in an atmosphere appropriate for permanent human habitation: not suitable for use in aggressive or explosive environments.

WARNING

Working in hazardous areas, or close to electrical installations or similar situations

Life Risk.

Precautions:

- ▶ Local safety authorities and safety experts must be contacted by the person responsible for the product before working in such conditions.



The following advice is only valid for battery charger, power adapter and car adapter.

Environment

Suitable for use in dry environments only and not under adverse conditions.



1.4

Responsibilities

Manufacturer of the product

Leica Geosystems AG, CH-9435 Heerbrugg, hereinafter referred to as Leica Geosystems, is responsible for supplying the product, including the User Manual and original accessories, in a safe condition.

Person responsible for the product

The person responsible for the product has the following duties:

- To understand the safety instructions on the product and the instructions in the User Manual.
- To ensure that it is used in accordance with the instructions.
- To be familiar with local regulations relating to safety and accident prevention.
- To inform Leica Geosystems immediately if the product and the application becomes unsafe.
- To ensure that the national laws, regulations and conditions for the operation of the product are respected.
- To ensure that the radio modem is not operated without the permission of the local authorities on frequencies and/or output power levels other than those specifically reserved and intended for use without a specific permit. The internal and external radio modems have been designed to operate on frequency ranges and output power ranges, the exact use of which differs from one region and/or country to another.

1.5

Hazards of Use

DANGER

Risk of electrocution

Because of the risk of electrocution, it is dangerous to use poles, levelling staffs and extensions in the vicinity of electrical installations such as power cables or electrical railways.

Precautions:

- ▶ Keep at a safe distance from electrical installations. If it is essential to work in this environment, first contact the safety authorities responsible for the electrical installations and follow their instructions.



WARNING

Distraction/loss of attention

During dynamic applications, for example stakeout procedures, there is a danger of accidents occurring if the user does not pay attention to the environmental conditions around, for example obstacles, excavations or traffic.

Precautions:

- ▶ The person responsible for the product must make all users fully aware of the existing dangers.

WARNING

Inadequate securing of the working site

This can lead to dangerous situations, for example in traffic, on building sites and at industrial installations.

Precautions:

- ▶ Always ensure that the working site is adequately secured.
 - ▶ Adhere to the regulations governing safety, accident prevention and road traffic.
-

CAUTION

Not properly secured accessories

If the accessories used with the product are not properly secured and the product is subjected to mechanical shock, for example blows or falling, the product may be damaged or people can sustain injury.

Precautions:

- ▶ When setting up the product, make sure that the accessories are correctly adapted, fitted, secured, and locked in position.
 - ▶ Avoid subjecting the product to mechanical stress.
-

WARNING

Incorrect fastening of the external antenna

Incorrect fastening of the external antenna to vehicles or transporters poses the risk of the equipment being broken by mechanical influence, vibration or airstream. This may result in accident and physical injury.

Precautions:

- ▶ Attach the external antenna professionally. The external antenna must be secured additionally, for example by use of a safety cord. Ensure that the mounting device is correctly mounted and able to carry the weight of the external antenna (>1 kg) safely.
-

WARNING

Lightning strike

If the product is used with accessories, for example masts, staffs, poles, you may increase the risk of being struck by lightning.

Precautions:

- ▶ Do not use the product in a thunderstorm.
-

 **DANGER**

Risk of being struck by lightning

If the product is used with accessories, for example on masts, staffs, poles, you may increase the risk of being struck by lightning. Danger from high voltages also exists near power lines. Lightning, voltage peaks, or the touching of power lines can cause damage, injury and death.

Precautions:

- ▶ Do not use the product in a thunderstorm as you can increase the risk of being struck by lightning.
- ▶ Be sure to remain at a safe distance from electrical installations. Do not use the product directly under or close to power lines. If it is essential to work in such an environment contact the safety authorities responsible for electrical installations and follow their instructions.
- ▶ If the product has to be permanently mounted in an exposed location, it is advisable to provide a lightning conductor system. A suggestion on how to design a lightning conductor for the product is given below. Always follow the regulations in force in your country regarding grounding antennas and masts. These installations must be carried out by an authorised specialist.
- ▶ To prevent damages due to indirect lightning strikes (voltage spikes) cables, for example for antenna, power source or modem should be protected with appropriate protection elements, like a lightning arrester. These installations must be carried out by an authorised specialist.
- ▶ If there is a risk of a thunderstorm, or if the equipment is to remain unused and unattended for a long period, protect your product additionally by unplugging all systems components and disconnecting all connecting cables and supply cables, for example, instrument - antenna.

 **WARNING**

Inappropriate mechanical influences to batteries

During the transport, shipping or disposal of batteries it is possible for inappropriate mechanical influences to constitute a fire hazard.

Precautions:

- ▶ Before shipping the product or disposing it, discharge the batteries by the product until they are flat.
- ▶ When transporting or shipping batteries, the person in charge of the product must ensure that the applicable national and international rules and regulations are observed.
- ▶ Before transportation or shipping, contact your local passenger or freight transport company.

 **WARNING**

Exposure of batteries to high mechanical stress, high ambient temperatures or immersion into fluids

This can cause leakage, fire or explosion of the batteries.

Precautions:

- ▶ Protect the batteries from mechanical influences and high ambient temperatures. Do not drop or immerse batteries into fluids.

⚠ WARNING

Short circuit of battery terminals

If battery terminals are short circuited e.g. by coming in contact with jewellery, keys, metallised paper or other metals, the battery can overheat and cause injury or fire, for example by storing or transporting in pockets.

Precautions:

- ▶ Make sure that the battery terminals do not come into contact with metallic objects.

For the AC power supply:

⚠ WARNING

If unit is not connected to ground, death or serious injury can occur.

Precautions:

- ▶ To avoid electric shock power cable and power outlet must be grounded.



The following advice is only valid for power adapter and car adapter.

⚠ WARNING

Electric shock due to use under wet and severe conditions

If unit becomes wet it may cause you to receive an electric shock.

Precautions:

- ▶ If the product becomes humid, it must not be used!
- ▶ Use the product only in dry environments, for example in buildings or vehicles.



- ▶ Protect the product against humidity.

The following advice is only valid for power adapter and car adapter.

⚠ WARNING

Unauthorised opening of the product

Either of the following actions may cause you to receive an electric shock:

- Touching live components
- Using the product after incorrect attempts were made to carry out repairs

Precautions:

- ▶ Do not open the product!
- ▶ Only Leica Geosystems authorised service centres are entitled to repair these products.



WARNING

Improper disposal

If the product is improperly disposed of, the following can happen:

- If polymer parts are burnt, poisonous gases are produced which may impair health.
- If batteries are damaged or are heated strongly, they can explode and cause poisoning, burning, corrosion or environmental contamination.
- By disposing of the product irresponsibly you may enable unauthorised persons to use it in contravention of the regulations, exposing themselves and third parties to the risk of severe injury and rendering the environment liable to contamination.

Precautions:

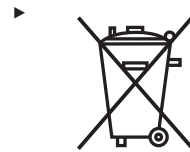

The product must not be disposed with household waste. Dispose of the product appropriately in accordance with the national regulations in force in your country. Always prevent access to the product by unauthorised personnel.

Product-specific treatment and waste management information can be received from your Leica Geosystems distributor.

WARNING

Improperly repaired equipment

Risk of injuries to users and equipment destruction due to lack of repair knowledge.

Precautions:

- ▶ Only authorised Leica Geosystems Service Centres are entitled to repair these products.

1.6

Laser Classification

1.6.1

General

General

The following chapters provide instructions and training information about laser safety according to international standard IEC 60825-1 (2014-05) and technical report IEC TR 60825-14 (2004-02). The information enables the person responsible for the product and the person who actually uses the equipment, to anticipate and avoid operational hazards.

- ☞ According to IEC TR 60825-14 (2004-02), products classified as laser class 1, class 2 and class 3R do not require:
 - laser safety officer involvement,
 - protective clothes and eyewear,
 - special warning signs in the laser working areaif used and operated as defined in this User Manual due to the low eye hazard level.
- ☞ National laws and local regulations could impose more stringent instructions for the safe use of lasers than IEC 60825-1 (2014-05) and IEC TR 60825-14 (2004-02).

General

The DISTO module built into the product produces a visible red laser beam which emerges from the window at the top of the product.

The laser product described in this section is classified as laser class 2 in accordance with:

- IEC 60825-1 (2014-05): "Safety of laser products"

These products are safe for momentary exposures but can be hazardous for deliberate staring into the beam. The beam may cause dazzle, flash-blindness and after-images, particularly under low ambient light conditions.

Description	Value
Wavelength	620 nm - 690 nm
Maximum average radiant power	0.95 mW
Pulse duration	> 400 ps
Pulse repetition frequency (PRF)	320 MHz
Beam divergance	0.16 mrad x 0.6 mrad

⚠ CAUTION

Class 2 laser product

From a safety perspective, class 2 laser products are not inherently safe for the eyes.

Precautions:

- ▶ Avoid staring into the beam or viewing it through optical instruments.
- ▶ Avoid pointing the beam at other people or at animals.

Labelling and location of laser aperture



Laser Radiation
 Do not stare into the beam.
 Class 2 Laser Product according to
 IEC 60825-1 (2014 - 05)
 $P_o \leq 0.95 \text{ mW}$
 $\lambda = 620 \text{ nm} - 690 \text{ nm}$

Description

The term Electromagnetic Compatibility is taken to mean the capability of the product to function smoothly in an environment where electromagnetic radiation and electrostatic discharges are present, and without causing electromagnetic disturbances to other equipment.

 WARNING**Electromagnetic radiation**

Electromagnetic radiation can cause disturbances in other equipment.

Precautions:

- ▶ Although the product meets the strict regulations and standards which are in force in this respect, Leica Geosystems cannot completely exclude the possibility that other equipment may be disturbed.
-

 CAUTION**Use of the product with accessories from other manufacturers. For example field computers, personal computers or other electronic equipment, non-standard cables or external batteries**

This may cause disturbances in other equipment.

Precautions:

- ▶ Use only the equipment and accessories recommended by Leica Geosystems.
 - ▶ When combined with the product, they meet the strict requirements stipulated by the guidelines and standards.
 - ▶ When using computers, two-way radios or other electronic equipment, pay attention to the information about electromagnetic compatibility provided by the manufacturer.
-

 CAUTION**Intense electromagnetic radiation. For example, near radio transmitters, transponders, two-way radios or diesel generators**

Although the product meets the strict regulations and standards which are in force in this respect, Leica Geosystems cannot completely exclude the possibility that function of the product may be disturbed in such an electromagnetic environment.

Precautions:

- ▶ Check the plausibility of results obtained under these conditions.
-

CAUTION

Electromagnetic radiation due to improper connection of cables

If the product is operated with connecting cables attached at only one of their two ends, for example external supply cables, interface cables, the permitted level of electromagnetic radiation may be exceeded and the correct functioning of other products may be impaired.

Precautions:

- ▶ While the product is in use, connecting cables, for example product to external battery, product to computer, must be connected at both ends.
-

WARNING

Use of product with radio or digital cellular phone devices

Electromagnetic fields can cause disturbances in other equipment, in installations, in medical devices, for example pacemakers or hearing aids and in aircrafts. Electromagnetic fields can also affect humans and animals.

Precautions:

- ▶ Although the product meets the strict regulations and standards which are in force in this respect, Leica Geosystems cannot completely exclude the possibility that other equipment can be disturbed or that humans or animals can be affected.
 - ▶ Do not operate the product with radio or digital cellular phone devices in the vicinity of filling stations or chemical installations, or in other areas where an explosion hazard exists.
 - ▶ Do not operate the product with radio or digital cellular phone devices near to medical equipment.
 - ▶ Do not operate the product with radio or digital cellular phone devices in aircrafts.
 - ▶ Do not operate the product with radio or digital cellular phone devices for long periods with the product immediately next to your body.
-

⚠ WARNING

This equipment has been tested and found to comply with the limits for a Class B digital device, pursuant to part 15 of the FCC rules.

These limits are designed to provide reasonable protection against harmful interference in a residential installation.

This equipment generates, uses and can radiate radio frequency energy and, if not installed and used in accordance with the instructions, may cause harmful interference to radio communications. However, there is no guarantee that interference will not occur in a particular installation.

If this equipment does cause harmful interference to radio or television reception, which can be determined by turning the equipment off and on, the user is encouraged to try to correct the interference by one or more of the following measures:

- Reorient or relocate the receiving antenna.
- Increase the separation between the equipment and the receiver.
- Connect the equipment into an outlet on a circuit different from that to which the receiver is connected.
- Consult the dealer or an experienced radio/TV technician for help.

⚠ CAUTION

Changes or modifications not expressly approved by Leica Geosystems for compliance could void the user's authority to operate the equipment.

Labelling CS20

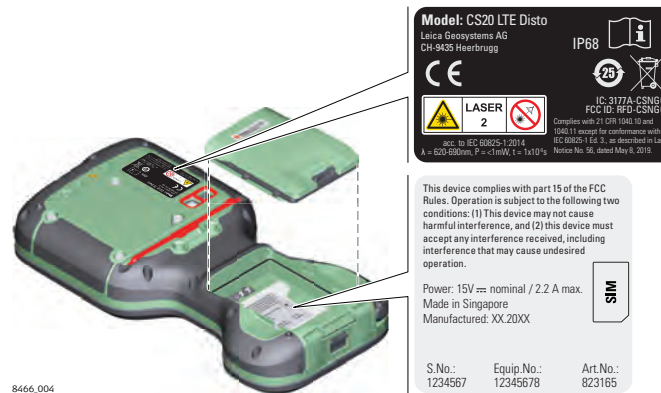

Labelling CTR20

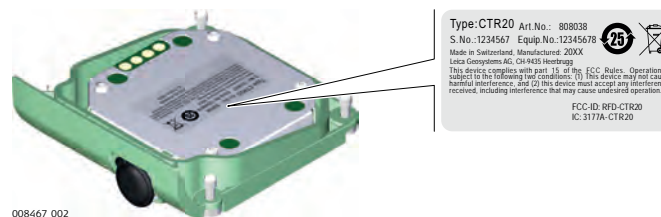

Labelling CGR4



14952.002

Model: CGR4 S.No.: 1234568
 Equip.No.: 12345678 Art.No.: 798498
 Leica Geosystems AG, CH-9435 Heerbrugg
 Made in Switzerland, Manufactured: 2017

Contains:
 FCC ID: MRBSATEL - TA23
 IC: 2422A - SATELTA23

003 - 170097

This device complies with part 15 of the FCC Rules. Operation is subject to the following two conditions:
 (1) This device may not cause harmful interference, and
 (2) This device must accept any interference received, including interference that may cause undesired operation.

Labelling GS07

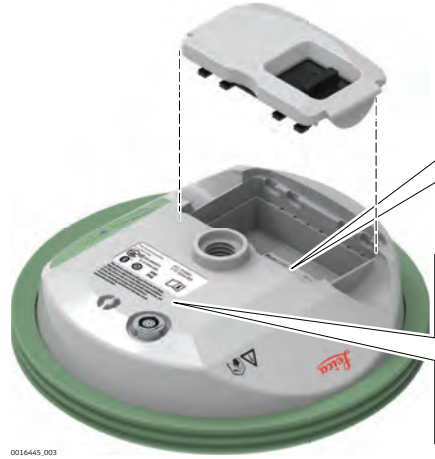

0016445.003

Model: GS07 Art.No.: 869374
 Equip. No.: 12345678 S.No.: 123456
 Power: 7.4V nominal / 0.6 A max.
 Leica Geosystems AG
 CH-9435 Heerbrugg
 Manufactured: 20XX
 Made in Switzerland

202-SMG072

This device contains a transmitter: FCC: P1VH0925 IC ID: 5325A-0925

This device complies with part 15 of the FCC Rules. Operation is subject to the following two conditions:
 (1) This device may not cause harmful interference AND
 (2) This device must accept any interference received, including interference that may cause undesired operation.

Labelling GEB331

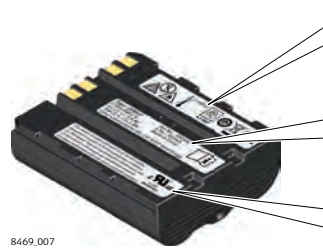

8469_007

Model 型號: GEB331 Art. No.: 799190
 Li-Ion Battery 鋰離子電池
 標電壓 1.1V 7.8 Ah S_N No.: XXXXX
 電流 15 A / 31.1Wh 31 Cr 19/66 FHS2319 TU114650-102034
 Leica Geosystems AG, CH-9435 Heerbrugg Made in China 中國製造
 AS-48 31 620 6262

This device complies with part 15 of the FCC Rules. Operation is subject to the following two conditions:
 (1) This device may not cause harmful interference, and
 (2) This device must accept any interference received, including interference that may cause undesired operation.

MH29443

Labelling internal battery GEB212



005044.002

Type: GEB212 Art. No.: 772806
 Li-Ion Battery 7.4V 2.6 Ah
 10A 5A/130°C 19Wh
 S. No.: 10412 Made in China 2ICR19/66
 Leica Geosystems AG, CH-9435 Heerbrugg

This device complies with part 15 of the FCC Rules. Operation is subject to the following two conditions:
 (1) This device may not cause harmful interference, and
 (2) This device must accept any interference received, including interference that may cause undesired operation.

Accessory E179078_70YL

 WARNING

This Class (B) digital apparatus complies with Canadian ICES-003.
Cet appareil numérique de la classe (B) est conforme à la norme NMB-003 du Canada.

Canada Compliance Statement

This device contains licence-exempt transmitter(s)/receiver(s) that comply with Innovation, Science and Economic Development Canada's licence-exempt RSS(s). Operation is subject to the following two conditions:

1. This device may not cause interference.
2. This device must accept any interference, including interference that may cause undesired operation of the device.

Canada Déclaration de Conformité

L'émetteur/récepteur exempt de licence contenu dans le présent appareil est conforme aux CNR d'Innovation, Sciences et Développement économique Canada applicables aux appareils radio exempts de licence. L'exploitation est autorisée aux deux conditions suivantes:

1. L'appareil ne doit pas produire de brouillage;
 2. L'appareil doit accepter tout brouillage radioélectrique subi, même si le brouillage est susceptible d'en compromettre le fonctionnement.
-

2

Description of the System

2.1

Overview

System components



0016300_002

2.2

Terminology

CS general description

CS is a collective term describing the various models of the multi-purpose field controller which is used with GNSS and TS instruments.

Available models

Model	CS20 (876476)	CS20 LTE (876477, 876479)	CS20 LTE DISTO (876478, 876480)
Touch screen	✓	✓	✓
Colour display	✓	✓	✓
Internal long-range TS communication radio	-	✓	✓
Internal LTE modem	-	✓	✓
Internal battery ¹	✓	✓	✓
DISTO	-	-	✓
SD card	✓	✓	✓
Bluetooth	✓	✓	✓
External long-range TS communication radio ¹	-	As expansion pack CTR20	
GNSS UHF RTK radio ¹	-	As expansion pack CGR4	
Wireless LAN 802.11b/g/n	✓	✓	✓
Windows EC 7	✓	✓	✓
Camera with flash	✓	✓	✓
Camera in DISTO	-	-	✓

¹ removable

2.3 System Concept

2.3.1 Software Concept

Software

Software type	Description
CS firmware (CS20LeicaCaptive.fw)	This software includes: <ul style="list-style-type: none">• The multi- language-specific version of Windows EC 7.• The necessary functionality of the instrument, including Leica Captivate.• The main applications and languages are integrated into the firmware. Languages cannot be deleted.• The software for the CGR4 UHF radio.

Software for the GS07

Software type	Description
ME firmware (ME_xx.fw)	This software includes: <ul style="list-style-type: none">- The firmware for the measurement engine.

Software upload

 Uploading firmware can take some time. Ensure that the battery is at least 75% full before beginning the upload, and do not remove the battery during the upload process.

Software for	Description
All CS models	<p>The software is stored in the flash RAM of the field controller.</p> <p>Firmware update instructions</p> <ul style="list-style-type: none">• Download the most recent firmware file from https://myworld.leica-geosystems.com.• Copy the firmware file into the \SYSTEM folder on the Leica SD card. <p> Ensure that the Leica SD card is inserted into the field controller before starting the upload.</p> <ul style="list-style-type: none">• Start Leica Captivate. To open the Update Software panel, select Settings > Tools > Update software.• Select the firmware file to upload and start the update process. When the update process is finished, the new version of Leica Captivate is started.
GS07	The software is stored in the flash RAM of the GS07.

Software for	Description
	<p>ME firmware update instructions</p> <ul style="list-style-type: none"> Go to www.myworld.leica-geosystems.com and log in. Go to myProducts and select your product. <p> If your product is not in the list, click Add Product.</p> <ul style="list-style-type: none"> Click the Software tab and download the software to your computer. Unzip the file and store the required files in the \SYSTEM directory of the data storage device. Insert the data storage device into the connected field controller and turn it on. Captivate: Go to Settings\Tools\Update software. File to load: Select the firmware to upload. Click OK. The software is uploaded to your product.
CGR4	<p>The software is stored in the UHF radio module in the CGR module.</p> <p>CGR UHF radio firmware update instructions</p> <ul style="list-style-type: none"> Download the most recent CS20 firmware file from https://myworld.leica-geosystems.com. Copy the CS20 firmware file into the \SYSTEM directory of the Leica SD card. Connect the CGR radio to the CS field controller and configure the CGR radio as RTK device. Refer to the Leica Captivate Technical Reference Manual. Select the firmware file to upload and start the update process. A message will appear when the upload is complete.

2.3.2

Power Concept

General

Use the batteries, chargers and accessories recommended by Leica Geosystems to ensure the correct functionality of the instrument.

Power options

Model	Power supply
All CS models	<p>Internally by GEB331 battery, OR</p> <p>Externally by GEV276 cable, OR</p> <p>Externally by GEV219 cable</p> <p>If an external power supply is connected and the internal battery is inserted, then the external power is used. The internal battery is charged.</p> <p>Please note: Charging functionality is not available for CS20 field controller.</p>

Model	Power supply
CTR20, CGR4	Externally by the field controller. Please note: Expansion pack support is not available for CS20 field controller.
GS07	Internally by GEB212 battery, OR Externally by GEV219 cable If an external power supply is connected and the internal battery is inserted, then the external power is used.

2.3.3

Data Storage Concept

Description

Data is stored on a memory device. The memory device can be an SD card, USB stick or internal memory.

Memory device

Device	Description
SD card	All field controllers have an SD card slot fitted as standard. An SD card can be inserted and removed. Available capacity: 1 GB, 8 GB.
USB stick	All field controllers have a USB port fitted as standard.
Internal memory	All field controllers have an internal memory fitted as standard. Available capacity: 4 GB.

 While other SD cards can be used, Leica Geosystems recommends to only use Leica SD cards and is not responsible for data loss or any other error that can occur while using a non-Leica card.



Removing the SD card or USB stick while the field controller is turned on can cause loss of data. Only remove the SD card or USB stick or unplug connecting cables when the field controller is switched off.

Transfer data

Data can be transferred in various ways.



SD cards can directly be used in an OMNI drive as supplied by Leica Geosystems. Other PC card drives can require an adaptor.

2.4

Container Contents

Container for GS instrument and accessories 1/2

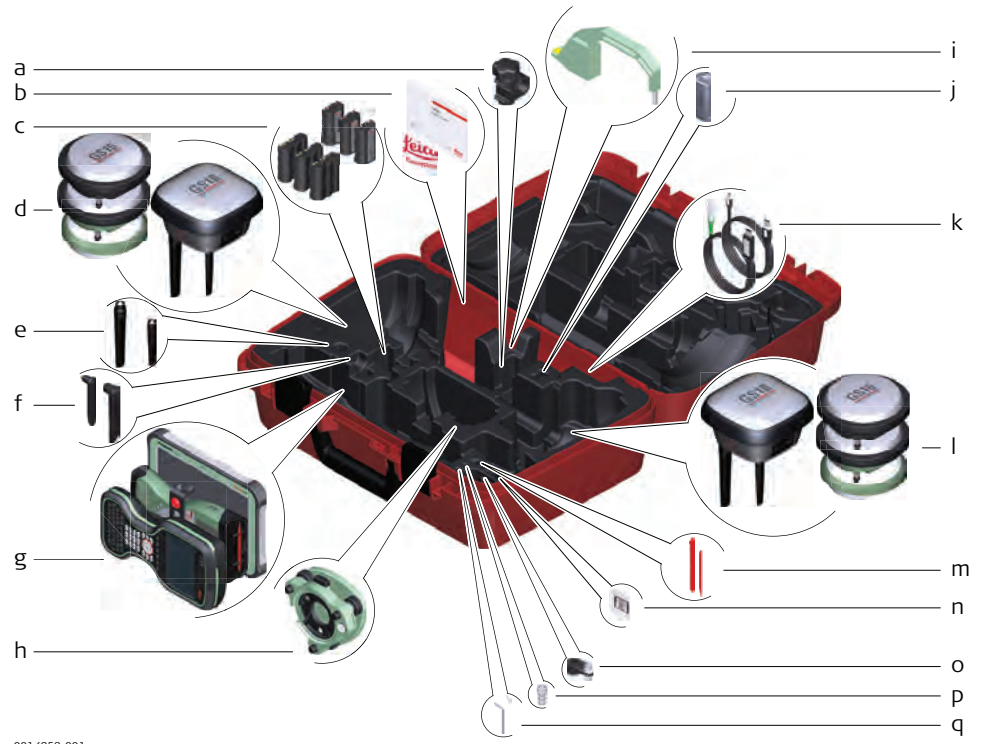

0014958_001

- a GHT63 clamp
- b Manuals and USB documentation card
- c GEB212 or GEB331 batteries
- d Antenna
- e GAT18, GAT27 or GAT28 mobile antenna
- f GAT21, GAT25 or GAT26 radio antenna
- g Field controller with holder or CS35 tablet
- h Tribrach
- i Height hook
- j USB stick
- k Cables
- l Antenna
- m Stylus
- n SD cards
- o GAD34 arm 3 cm
- p TNC QN-adaptor
- q Allen key and adjustment tool

Container for GS instrument and accessories 2/2



0014961_001

- a GHT36 base for telescopic rod
- b Antenna arm
- c GFU RTK modem
- d GAD32 telescopic rod
- e GAT1 or GAT2 radio antennas
- f GEB212 or GEB331 batteries
- g GRT146 or GRT247 carrier
- h GAD33 arm
- i GHT58 tripod bracket for GFU
- j External battery

Container for GS instrument and accessories



0014955.001

- a Field controller with holder
- b Antenna
- c CRP15, quick release adaptor for quick mounting and demounting the GS18 to the pole without screwing
- d GAT25, GAT26, GAT27 or GAT28 antenna
- e Stylus
- f GHT63 clamp
- g USB stick
- h GAT1 or GAT2 radio antennas
- i Antenna arm
- j microSD card including adapter or SD card
- k Manual & USB documentation card
- l GEB212 or GEB331 batteries

2.5

CS Components

Upside of CS20



- a DISTO with camera
- b Screen
- c Keyboard
- d Connector cover
- e Power socket
- f SD card slot
- g USB A host port
- h LEMO port (USB and serial)

Underside of CS20

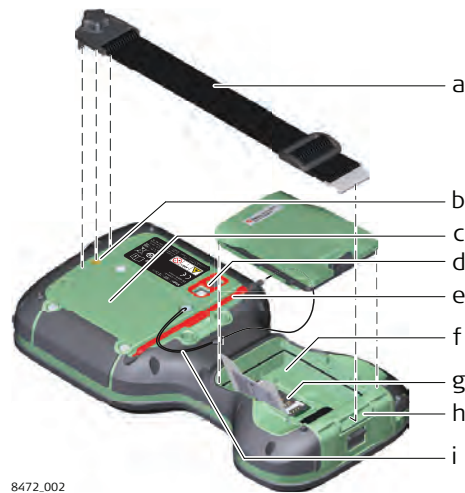

- a Hand strap
- b Thread for screwing on hand strap or utility hook
- c Expansion cover
- d Digital camera with flash
- e Stylus
- f Battery compartment
- g SIM card slot under the battery
- h Socket for fastening clip of the hand strap
- i Tether for the stylus

2.6

GS07 Components

GS07 components

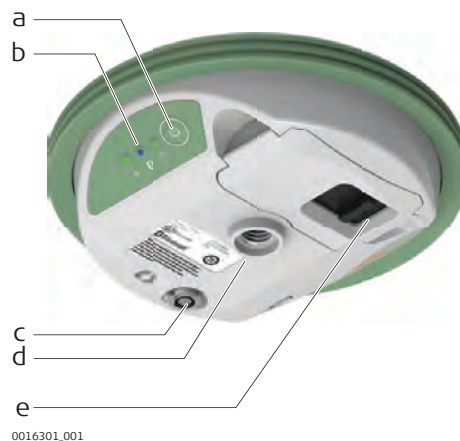

- a ON/OFF button
- b LEDs
- c LEMO port including USB port
- d Antenna Reference Plane (ARP)
- e Battery compartment

3

User Interface

3.1

Keyboard

Keyboard display

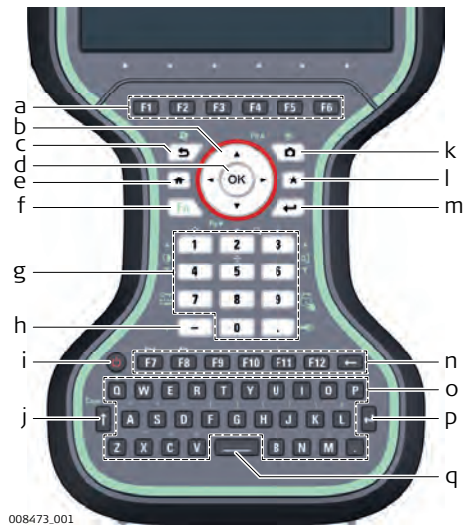







008473_001





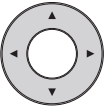





















- a Function keys **F1 - F6**
- b Arrow keys
- c ESC
- d OK
- e Home
- f **Fn**
- g Numeric keys
- h ± key
- i ON/OFF
- j CAPS Lock
- k Cameras
- l Favourites
- m ENTER
- n Function keys **F7 - F12**;
Backspace
- o Alpha keys
- p ENTER
- q SPACE











Keys

Key	Function
Function keys F1-F6	Correspond to six softkeys that appear on the bottom of the screen when the screen is activated.
Function keys F7-F12	User definable keys to execute chosen commands or access chosen screens.
Alpha keys	To type letters.
Numeric keys	To type numbers.
Caps Lock	Switches between upper case and lower case letters.
Backspace	Clears all entry at the beginning of user input. Clears the last character during user input.
Esc	Leaves the current screen without storing any changes.
Fn	Switches between the first and second level of function keys.
Space	Enters a blank.
Enter	Selects the highlighted line and leads to the next logical menu/ dialog. Starts the edit mode for editable fields. Opens a selectable list.

Key		Function
ON/OFF		If the field controller is already off: Turns the field controller on when held for 2 s. If the field controller is already on: <ul style="list-style-type: none"> • Turns to Power Options menu when held for 2 s. • Turns the field controller off when held for 5 s.
Favourites		Opens the "Favourites" pop-up bubble within Leica Captivate.
Home		Switches to the Home Menu.
Cameras		Access the cameras.
Arrow keys		Move the focus on the screen.
OK		Selects the highlighted line and leads to the next logical menu/ dialog. Starts the edit mode for editable fields. Opens a selectable list.
Backspace		Deletes the job in the centre of the job carousel.

Key combinations

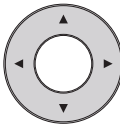
Key		Function
	+ 	Hold Fn while pressing  . Switch to Windows.
	+ 	Hold Fn while pressing  . Take a screenshot of the current screen.
	+  	Hold Fn while pressing  . Increase the screen brightness.
	+  	Hold Fn while pressing  . Decrease the screen brightness.
	+  	Hold Fn while pressing  . Increase the volume for acoustic warning signals, beeps and keypresses on the field controller.
	+  	Hold Fn while pressing  . Decrease the volume for acoustic warning signals, beeps and keypresses on the field controller.
	+  	Hold Fn while pressing  . Lock/unlock the keyboard.

Key	Function
 +  	Hold Fn while pressing  . Lock/unlock the touch screen.
 +  	Hold Fn while pressing  . Turn the torch on/off.
 + 	Hold Fn while pressing  or  . Switch to the previous/next page.

3.2

Keyboard and touch screen

Operating Principles

The user interface is operated either by the keyboard or by the touch screen with supplied stylus. The workflow is the same for keyboard and touch screen entry, the only difference lies in the way information is selected and entered.

Operation by keyboard

Information is selected and entered using the keys. Refer to [3.1 Keyboard](#) for a detailed description of the keys on the keyboard and their function.

Operation by touch screen

Information is selected and entered on the screen using the supplied stylus.

Operation	Description
To select an item	Tap on the item.
To start the edit mode in editable fields	Tap on the editable field.
To highlight an item or parts of it for editing	Drag the supplied stylus from the left to the right.
To accept data entered into an editable field and exit the edit mode	Tap on the screen outside of the editable field.
To open a context-sensitive menu	Tap on the item and hold for 2 s.

3.3

LED indicators

LED Indicators on CS20

The field controller has **L**ight **E**mitting **D**iode indicators. They indicate the basic field controller status.



008513.001

- a Power LED
- b Bluetooth LED
- c Long range TS LED - not available for CS20 field controller

Description of the LEDs

LED	LED Status	Status of Field Controller
Power LED	off	Power is off.
	green	Power is okay.

LED	LED Status	Status of Field Controller
	flashing green	Power is okay. The battery is being charged.
	red	Power is low. The remaining time for which enough power is available depends on the use of wireless modules, the temperature and the age of the battery.
	flashing red	Power is low. The remaining time for which enough power is available depends on the use of wireless modules, the temperature and the age of the battery. The battery is being charged.
	fast flashing red	Power is very low. The battery must be charged.
Bluetooth LED and Long range TS LED	blue	Bluetooth is connected.

3.4

LED Indicators on GS07

LED indicators

Description

The GS07 instrument has Light Emitting Diode indicators. They indicate the basic instrument status.

Diagram

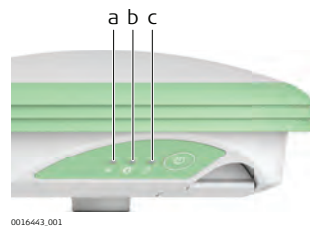

- a Tracking LED (TRK)
- b Bluetooth LED (BT)
- c Power LED (PWR)

Description of the LEDs

IF the	is	THEN
TRK LED	off	No satellites are tracked.
	flashing green	Less than four satellites are tracked, a position is not yet available.
	green	Enough satellites are tracked to compute a position.
	red	GS07 instrument is initialising.
BT LED	green	Bluetooth is in data mode and ready for connecting.
	blue	Bluetooth has connected.
	flashing blue	Data is being transferred.

IF the	is	THEN
GS07 PWR LED	off	Power is off.
	green	Power is 100% - 20%.
	red	Power is 20% - 5%.
	flashing red	Power is low (<5%). The remaining time for which enough power is available depends on the type of survey, the temperature and the age of the battery.

4 Operation

4.1 Equipment Setup

4.1.1 Setting up as a Post-Processing Base

Use The equipment setup described is used for static operations over markers.

Description The instrument can be programmed with the field controller before use which can then be omitted from the setup.



- The antenna is mounted directly using screw fitting. If using stub and adapter, procedures can vary slightly.
- When using the adapter and carrier, ensure that the antenna and the adapter assembly slide down the full length of the carrier stub. An incorrectly mounted antenna will have a direct effect on the results.



If the instrument is left in the container during use in high temperatures, the lid should be left open. Refer to the User Manual for operating and storage temperatures.



Use an external battery such as GEB371 to ensure operation for a full day.

Equipment setup

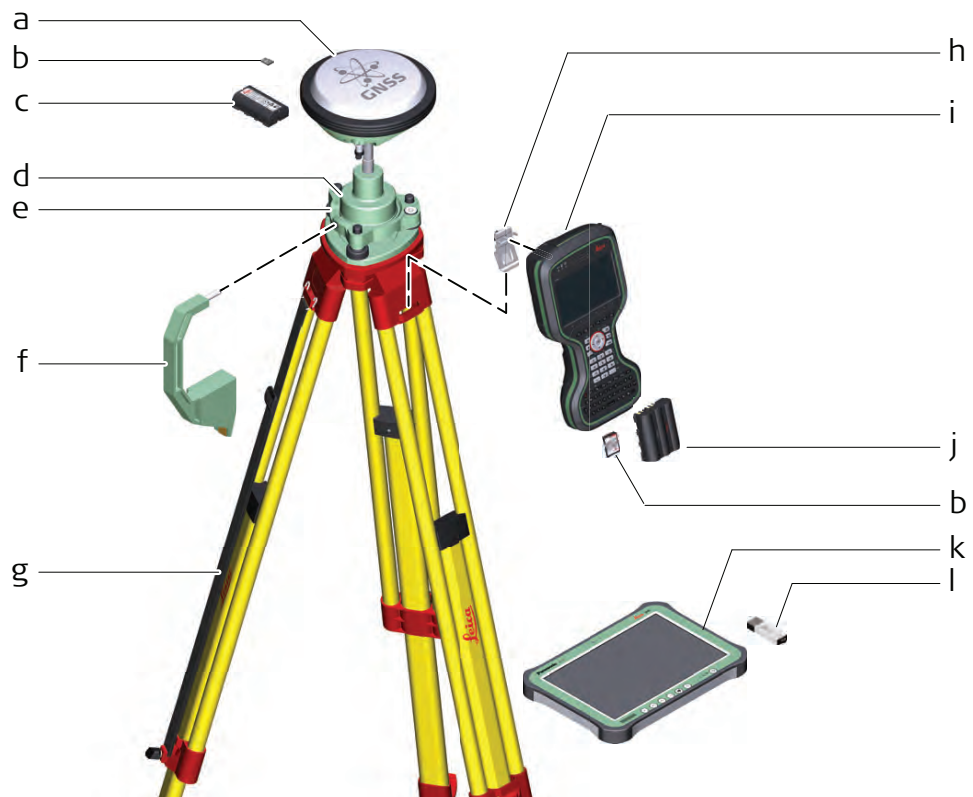

- a GS instrument
- b (micro)SD card
- c GEB212 battery
- d GRT146 carrier
- e Tribrach
- f Height hook
- g Tripod
- h Utility hook
- i CS20 field controller
- j GEB331 battery
- k CS35 tablet
- l USB stick

Equipment setup step-by-step

1. Set up the tripod.
2. Mount and level the tribrach on the tripod.
3. Ensure that the tribrach is over the marker.
4. Place and lock the carrier in the tribrach.
5. Insert the data storage device and the batteries into the GS.
6. Screw the GS onto the carrier.
7. Check that the tribrach is still level.
8. Insert the data storage device and the battery into the field controller.
9. Switch on the field controller and connect it to the instrument if necessary.
10. To hang the field controller on the tripod leg, use the hook on the hand strap or use the utility hook. Refer to the User Manual of the field controller.
11. Insert the height hook into the carrier.
12. Measure the antenna height using the height hook.
13. Press the ON/OFF button on the instrument for at least 2 s to switch on the instrument.

4.1.2

Fixing the Field Controller to a Holder and Pole

Components of the GHT66 holder

The GHT66 holder consists of the following components:



GHT63 clamp

- a Plastic sleeve
- b Pole clamp
- c Clamp bolt

GHT66 holder

- d Locking pin
- e Top clip
- f Mounting plate
- g Bottom clip
- h Tightening screw
- i Mounting arm

Fixing the field controller and GHT66 to a pole step-by-step

 For an aluminium pole, fit the plastic sleeve to the pole clamp.

1. Insert the pole into the clamp hole.
2. Attach the holder to the clamp using the clamp bolt.
3. Adjust the angle and the height of the holder on the pole to a comfortable position.
4. Tighten the clamp with the clamp bolt.
5. Before placing the CS field controller onto the mounting plate, ensure that the locking pin is put into the unlocked position. To unlock the locking pin, push the locking pin to the left.

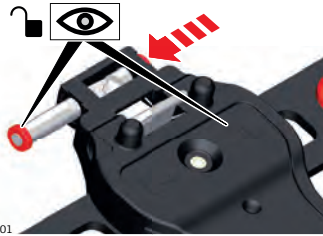

008546_001

6. Hold the CS field controller above the holder and lower the end of the CS field controller into the mounting plate.
7. Apply slight pressure in a downward direction and then lower the top part of the CS field controller until the unit is clicked into the holder. The guides of the mounting plate aid in this action.



008547_001

8. After the CS field controller is placed onto the mounting plate, ensure that the locking pin is put into the locked position. To lock the locking pin, push the locking pin to the right.

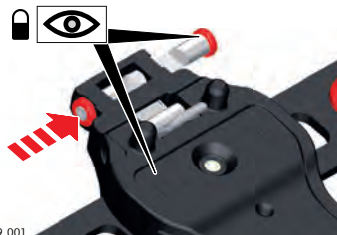

008549_001

Detaching the field controller from a pole step-by-step

1. Unlock the locking pin by pushing the locking pin to the left of the mounting plate.
2. Place your palm over the top of the field controller.

3. While in this position, lift the top of the field controller from the holder.



4.1.3

Fixing a Hand Strap to the CS

Fixing the hand strap (GHT67) step-by-step

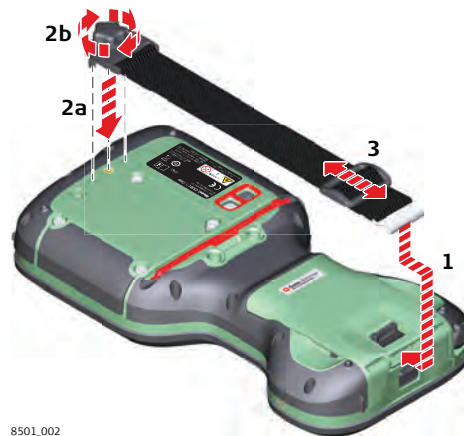

Turn over the field controller.

1. Take the end of the hand strap and clip it to the socket at the bottom of the field controller.
2. Place the screw of the main hook into the thread at the top of the field controller and fasten it.
3. Adjust the length of the hand strap.

4.1.4

Fixing the Utility Hook to the CS

Fixing the utility hook (GHT68) step-by-step

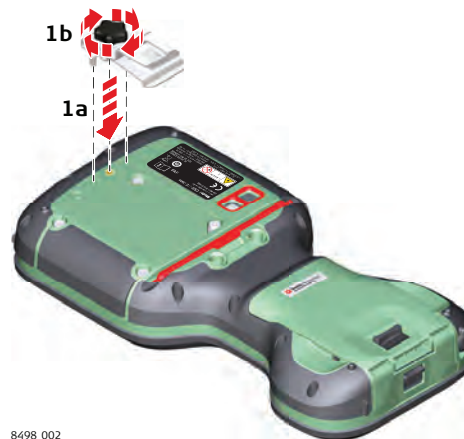

☞ If the hand strap is already attached to field controller, you need to detach it before you can fix the utility hook.

☞ Turn over the field controller.

1. Place the screw of the utility hook into the thread at the top of the field controller and fasten it.

4.1.5

Replacing the Display Foil on the CS



On delivery, the display of the CS is covered by a foil to protect the display against scratches and dirt and to guarantee a trouble-free function of the touchscreen in extreme and humid weather conditions. We strongly recommend to use this display foil and to replace it, if necessary.

Preparation

- Remove the old display foil.
- Ensure that the display is free of dust and grease.
- Use the provided microfibre cloth to clean the display.
- Look for a dust free and dry atmosphere surrounding while fixing the display foil. The recommended conditions are:
Temperature: approx. 21°C
Humidity: < 55%

Fixing the display foil step-by-step

The display foil lies between two thin carrier foils. The display foil has a silver-coloured sticker to peel away the carrier foil from the actual display foil.

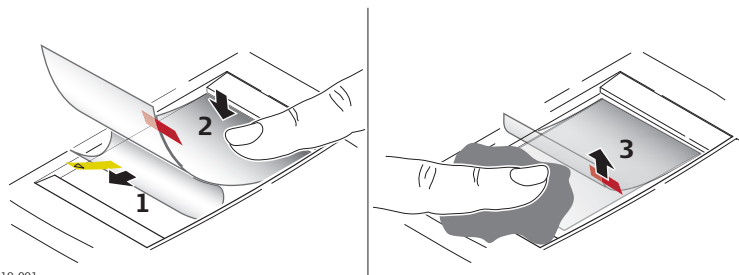

1. Touch the yellow-coloured sticker with two fingers and pull it slowly upwards. The carrier foil is peeling away.
☞ Do not peel the carrier foil more than 2 cm - 3 cm away.
2. Fix the adhesive underside of the display foil on the display edge. Peel away the carrier foil slowly and smooth it out gently onto the display.
3. Remove the additional layer foil which has a red-coloured sticker.
4. Potential air bubbles between display and display foil have to be smoothed out using the included microfibre cloth.
☞ Do not use sharp objects!
5. In case of remaining dust or grease under the display foil or the need to replace the display foil, lift it again with some adhesive tape.

4.1.6

Inserting and Removing a SIM Card

Insert and remove a SIM card step-by-step

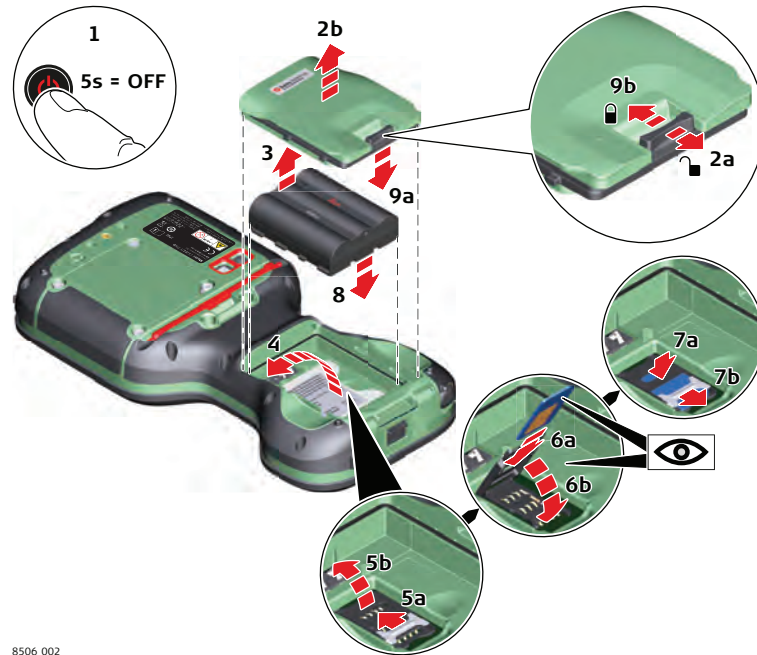

8506_002

 Inserting/removing the SIM card while the CS20 is turned on can result in permanent damage to the card. Only insert/remove the SIM card when the CS20 is switched off.

 The SIM card is inserted into a slot inside the battery compartment.

1. Switch off the field controller.
2. Push the slide fastener of the battery compartment in the direction of the arrow with the open-lock symbol. Remove the cover from the battery compartment.
3. Remove the battery from the battery compartment.
4. Bend up the flap that covers the SIM card holder.
5. Push the SIM card holder in the direction of the OPEN arrow and flip it up.
6. Place the SIM card into the SIM card holder, the chip facing the connectors inside the slot - as shown beside the SIM card holder.
7. Press the SIM card holder down and push the SIM card holder in the direction of the LOCK arrow to close.
8. Bend down the flap again and reinsert the battery.
9. Attach the cover of the battery compartment. Push the slide fastener of the battery compartment in the direction of the arrow with the closed-lock symbol.

4.1.7

Setting Up for Remote Control or RTK using an Expansion Pack

Attaching the extension pack step-by-step

This section does only apply to the CS20 LTE (DISTO) models.

 The **CTR20** is not available in EU countries.

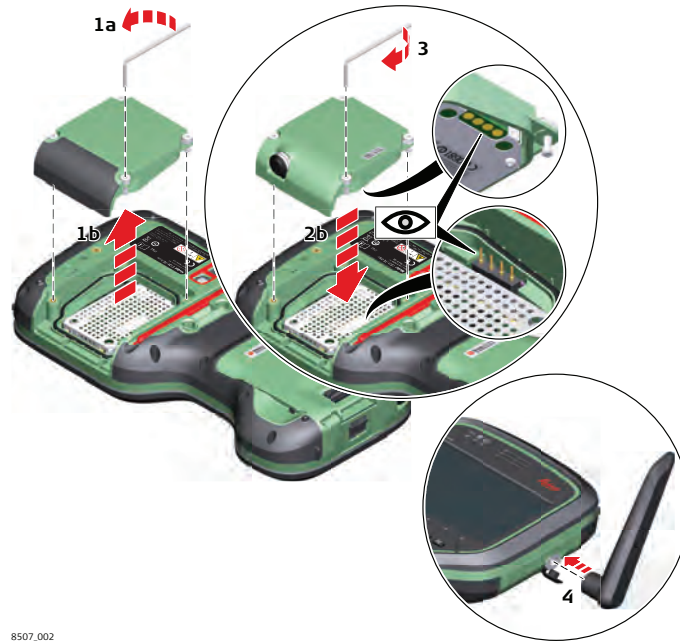

8507.002



When the expansion cover or expansion pack are detached from the field controller, the IP68 protection does not apply! Look for a dry and dust free atmosphere when detaching the expansion cover or the expansion pack.

1. Loosen the screws of the expansion cover and detach the cover from the field controller.

2.  Check the position of the contacts in the inner surface of the field controller.
Attach the expansion pack to the field controller.

3. Tighten the screws of the expansion pack with the supplied allen key.

4. Attach the antenna to the expansion pack.
 Using a rotating movement makes it easier to attach the antenna, especially at low temperatures.

4.1.8

Connecting to a Personal Computer

Description

Windows Mobile Device Center for PC with Windows 7/Windows 8/Windows 10 operating system is the synchronization software for Windows mobile-based pocket PC. WMDC enables a PC and a Windows mobile-based pocket PC to communicate.

Leica USB drivers support Windows 7, Windows 8 (8.1) and Windows 10 operating systems.

Cables

Leica USB drivers support:

Name	Description
GEV223	USB data cable, 1.8 m, connects instrument to Mini-USB to USB
GEV234	USB data cable, 1.65 m, connects CS to GS or CS to PC (USB)

Name	Description
GEV261	Y-cable, 1.8 m, connects instrument to PC – battery

Uninstalling the previous drivers

☞ Skip the following steps if you have never installed Leica USB drivers before.

If older drivers were previously installed on the PC, follow the instructions to uninstall the drivers prior the installation of the new drivers.

1. Connect your instrument to the PC via cable.
2. On your PC, select to **Control Panel > Device Manager**.
3. In **Network Adapters**, right-click on **Remote NDIS based LGS...**
4. Click on **Uninstall**.

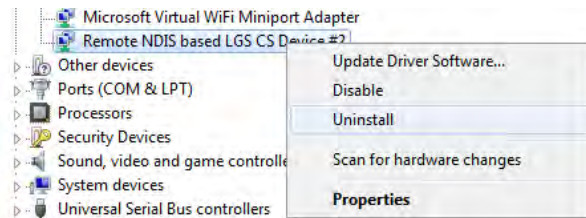

5. Set **Delete the driver...** as checked. Press **OK**.



Install Leica USB drivers

1. Start the PC.
2. Run the **Setup_Leica_USB_XXbit.exe** to install the drivers necessary for Leica devices. Depending on the version (32bit or 64bit) of the operating system on your PC, you have to select between the three setup files following:
 - Setup_Leica_USB_32bit.exe
 - Setup_Leica_USB_64bit.exe
 - Setup_Leica_USB_64bit_itanium.exe

☞ To check the version of your operating system, go to **Control Panel > System > System type**.

☞ The setup requires administrative privileges.

☞ The setup has to be run only once for all Leica devices.

3. The **Welcome to InstallShield Wizard for Leica GS, TS/TM/MS, CS and GR USB drivers** window appears.

☞ Ensure that all Leica devices are disconnected from your PC before you continue!



4. Click **Next>**.
5. The **Ready to Install the Program** window appears.

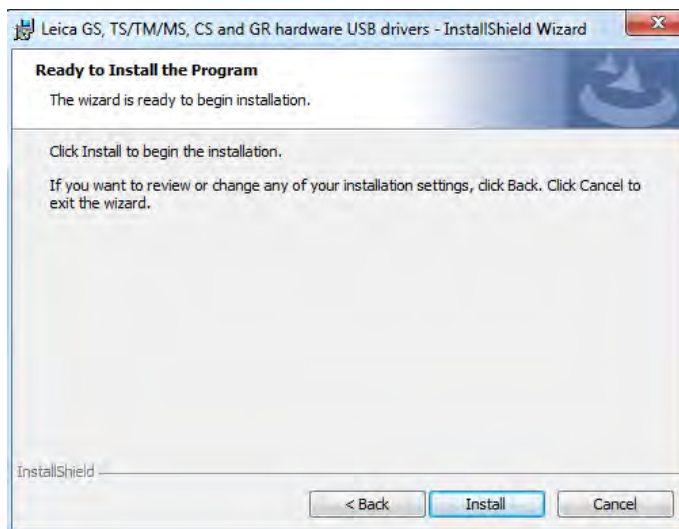

6. Click **Install**. The drivers will be installed on your PC.
7. The **InstallShield Wizard Completed** window appears.
8. Click **Finish** to exit the wizard.

Connect to PC via USB cable step-by-step

1. Start the PC.
2. Plug the cable into the instrument.
3. Turn on the instrument.
4. Plug the cable into the USB port of the PC.
5. Press the Windows Start button at the bottom left corner of the screen.
6. Type the IP address of the device into the search field.
 - \\192.168.254.1\ for field controller
7. Press **Enter**.

A file browser opens. You can now browse within the folders on the instrument.

4.1.9

Enabling WLAN in Windows EC7

Enabling WLAN step-by-step



By default, the WLAN module is disabled to save battery power.

1. In order to minimise **Leica Captivate**, press **Fn** and **ESC**.
 2. Select **Start\Settings\Network and Dial-Up Connections**.
 3. In the **Network Connections** window:
Tap the **TIWLNAPI1** icon and select **File\Enable**.
OR
Hold the stylus on the **TIWLNAPI1** icon. Select **Enable** from the context menu.
-

4.2

Batteries

4.2.1

Operating Principles

First-time use/ charging batteries

- The battery must be charged before using it for the first time because it is delivered with an energy content as low as possible.
 - The permissible temperature range for charging is from 0 °C to +40 °C/+32 °F to +104 °F. For optimal charging, we recommend charging the batteries at a low ambient temperature of +10 °C to +20 °C/+50 °F to +68 °F if possible.
 - It is normal for the battery to become warm during charging. Using the chargers recommended by Leica Geosystems, it is not possible to charge the battery once the temperature is too high.
 - For new batteries or batteries that have been stored for a long time (> three months), it is effectual to make only one charge/discharge cycle.
 - For Li-Ion batteries, a single discharging and charging cycle is sufficient. We recommend carrying out the process when the battery capacity indicated on the charger or on a Leica Geosystems product deviates significantly from the actual battery capacity available.
-

Operation/discharging

- The batteries can be operated from -30°C to +60°C/-22°F to +140°F.
 - Low operating temperatures reduce the capacity that can be drawn; high operating temperatures reduce the service life of the battery.
-

Insert and remove the battery step-by-step

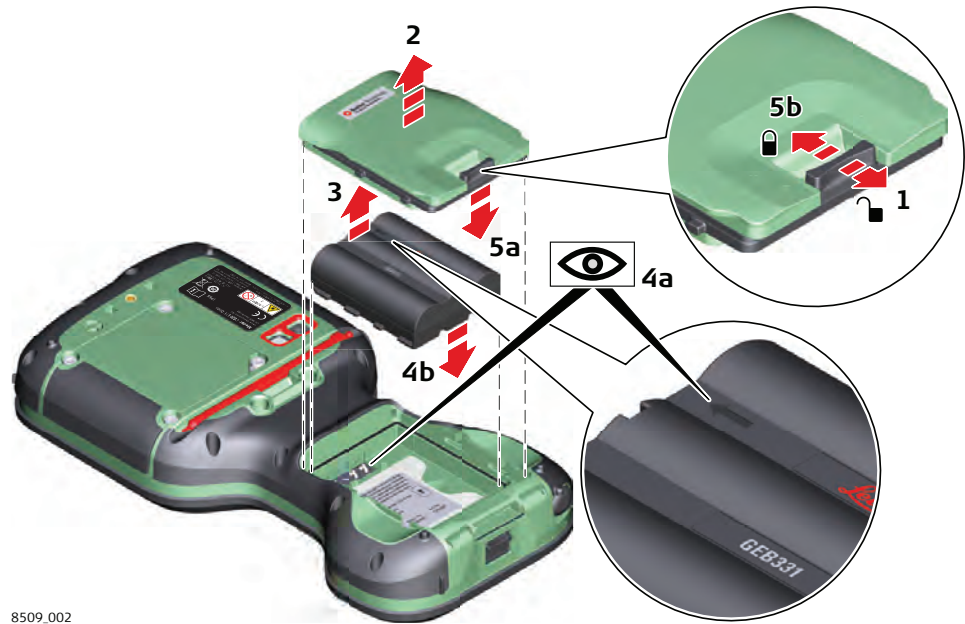

8509_002



Turn over the field controller.

1. Push the slide fastener in the direction of the arrow with the open-lock symbol.
2. Remove the cover from the battery compartment.
 -  Ensure that no water enters the battery compartment. IP68 applies only with the battery compartment closed.
3. Pull the battery from the battery compartment.
4. Place the battery into the battery compartment with the arrow facing to the top.
5. Attach the cover of the battery compartment. Push the slide fastener of the battery compartment in the direction of the arrow with the closed-lock symbol.

Insert and remove the battery on the GS07 step-by-step

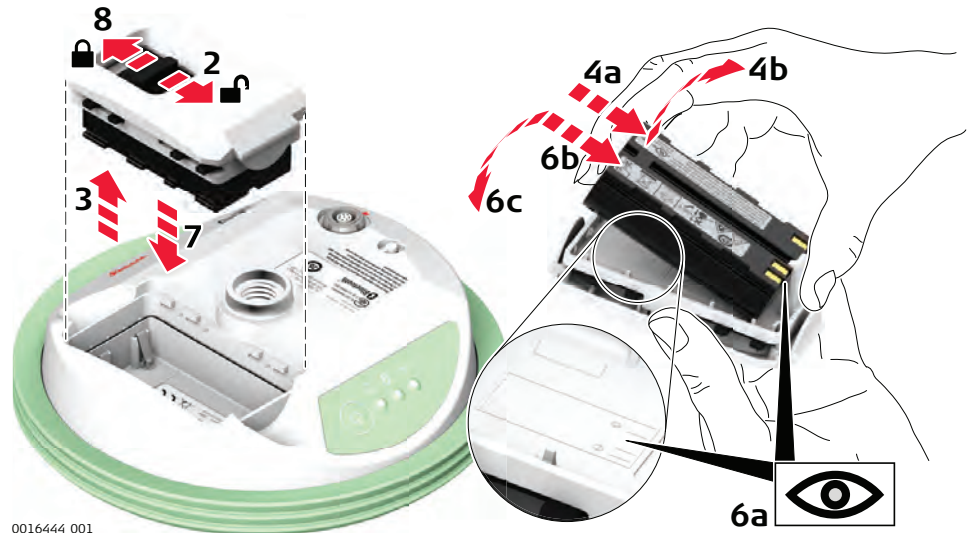

0016444_001

1. Turn GS07 over to gain access to the battery compartment.
2. Open the battery compartment by pushing the slide fastener in the direction of the arrow with the open-lock symbol.
3. Pull out the battery housing. The battery is attached to the housing.
4. Hold the battery housing and pull the battery from the battery housing.
5. A polarity of the battery is displayed inside the battery housing. This is a visual aid to assist in placing the battery correctly.
6. Place the battery onto the battery housing, ensuring that the contacts are facing outward. Click the battery into position.
7. Close the battery compartment by pushing the slide fastener in the direction of the arrow with the close-lock symbol.

4.2.3

Charging the Battery

Charge the battery inside the CS20 step-by-step



Please note: Charging functionality is not available for CS20 field controller (876476).

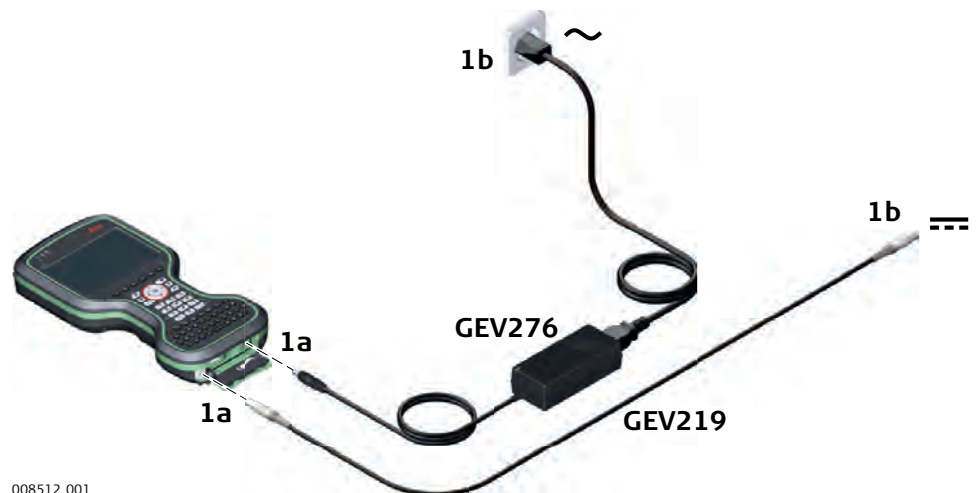

008512_001

1. Connect the GEV276 power adapter or GEV219 with the field controller.
2. The power LED on the CS field controller switches on. While charging, the power LED flashes. When the field controller's battery is fully charged the Power LED is green.
 -  Refer to [LED indicators](#) for detailed information about the power LED.



Charge battery for GS07

To charge the batteries for GS07, use the Leica Geosystems chargers GKL311 or GKL341. Refer to the GKL311 or GKL341 User Manual for further information.



4.3

Power Functions



Turning field controller on

Press and hold power key () for 2 s.
 The field controller must have a power supply.

Turning field controller off

Press and hold power key () for 5 s.
 The field controller must be on.

Menu "Power Down Options"

Press and hold power key () for 2 s to open **Power Down Options** menu.
 The field controller must be on.

Option	Description
Power down and turn off	To turn the field controller off.
Put into stand-by	To put the field controller into stand-by mode.
Reset hardware	Perform one of the following options: <ul style="list-style-type: none"> • Restart hardwareThe device powers down and restarts. • Reset Windows EC7The device powers down and restarts. Any Bluetooth pairings are deleted. • Reset Leica CaptivateThe device powers down and restarts. All working styles, dial-up lists and server lists are deleted. Jobs, code lists, coordinate systems etc. are not deleted. • Reset Windows EC7 and Leica CaptivateThe device powers down and restarts. Bluetooth pairings, working styles, dial-up lists and server lists are deleted.

Turn on GS07

To turn on the instrument press and hold the ON/OFF button for 2 s.

Turn off GS07

To turn off the instrument press and hold the ON/OFF button for 2 s.

4.4 Working with the Memory Device

4.4.1 Working with the SD Card



- Keep the card dry.
- Use it only within the specified temperature range.
- Do not bend the card.
- Protect the card from direct impacts.



Failure to follow these instructions could result in data loss and/or permanent damage to the card.

Insert and remove the SD card step-by-step

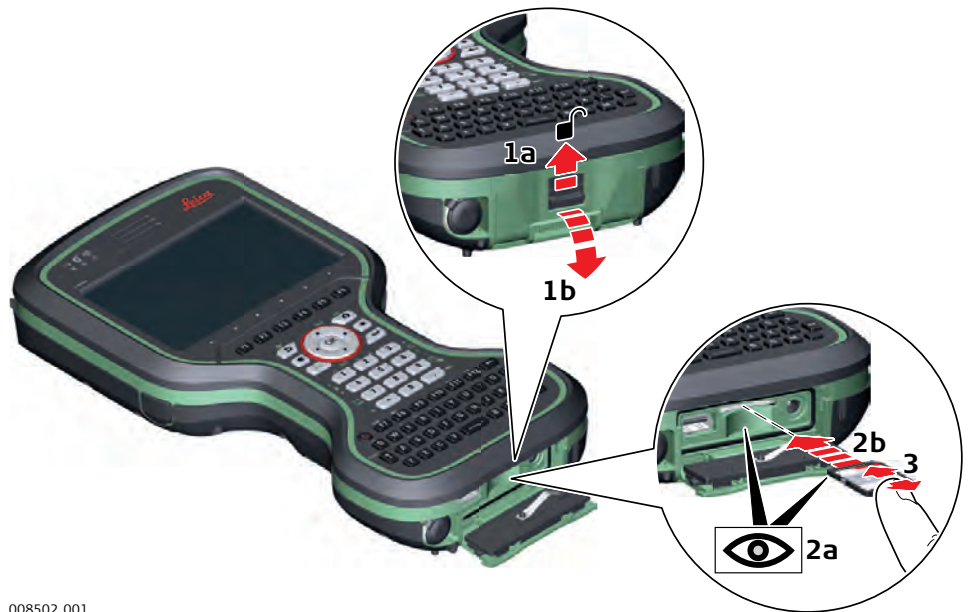

008502.001



The SD card can be inserted into a slot behind the connector cover.

1. Push the slide fastener of the connector cover in the direction of the arrow with the open-lock symbol. Open the connector cover.
2. Hold the card with the contacts facing the slot. Slide the card firmly into the slot until it clicks into position.
 Do not force the card into the slot.
3. To release the card from the slot, gently press the top of the card. The card pops out and you can remove it from the slot.
4. Close the connector cover. Push the slide fastener of the battery compartment in the direction of the arrow with the closed-lock symbol.

4.4.2

Working with a USB Memory Stick

Insert a USB stick step-by-step



008504.001



The USB stick can be inserted into a slot behind the connector cover.

1. Push the slide fastener of the connector cover in the direction of the arrow with the open-lock symbol. Open the connector cover.
2. Insert the USB stick into the USB A host port.

4.5

Using the Digital Camera

Overview

The field controller is equipped with a digital camera and a flash light, both located at the underside. Mounting a hand strap or pole holder plate does not limit the camera view.

You can start the camera application from within Leica Captivate.

Taking a picture step-by-step



To be able to start the camera application, Leica Captivate has to be open.

1. Press the Camera key .
The screen **Capture Image** is displayed.
2. Aim the camera to the desired target.
3. Check the view at the display.
4. Press the **OK** key or click **Capture** to take a picture.
The picture is displayed in the **Image Viewer**.



Capture changes to **Store**.

5. Press **OK** again or click **Store** to store the picture.
An info screen is displayed where you can choose to save the picture with a link to a point, line or area.
6. Press **F2** or **F3** to store the picture with a link. Follow the instructions on the screen.
Press **F4** to store the picture without a link.
Press **F6** to return to the **Image Viewer** without storing the picture.



After storing the picture, the **Capture Image** screen is displayed again.

4.6

Using the Camera Flash Light as Torch

Using the flash light as torch

You can use the flash light of the camera as torch.

To put the flash light on/off, hold  and press .

5 Care and Transport

5.1 Transport

Transport in a road vehicle

Never carry the product loose in a road vehicle, as it can be affected by shock and vibration. Always carry the product in its container and secure it.

For products for which no container is available use the original packaging or its equivalent.

Shipping

When transporting the product by rail, air or sea, always use the complete original Leica Geosystems packaging, container and cardboard box, or its equivalent, to protect against shock and vibration.

Shipping, transport of batteries

When transporting or shipping batteries, the person responsible for the product must ensure that the applicable national and international rules and regulations are observed. Before transportation or shipping, contact your local passenger or freight transport company.

5.2 Storage

Product

Respect the temperature limits when storing the equipment, particularly in summer if the equipment is inside a vehicle. Refer to [6 Technical Data](#) for information about temperature limits.

Li-Ion batteries

- Refer to [6 Technical Data](#) for information about storage temperature range.
- Remove batteries from the product and the charger before storing.
- After storage recharge batteries before using.
- Protect batteries from damp and wetness. Wet or damp batteries must be dried before storing or use.
- A storage temperature range of 0 °C to +30 °C / +32 °F to +86 °F in a dry environment is recommended to minimize self-discharging of the battery.
- At the recommended storage temperature range, batteries containing a 40% to 50% charge can be stored for up to one year. After this storage period the batteries must be recharged.

5.3 Cleaning and Drying

Product and accessories

- Use only a clean, soft, lint-free cloth for cleaning. If necessary, moisten the cloth with water or pure alcohol. Do not use other liquids; these may attack the polymer components.

Damp products

Dry the product, the transport container, the foam inserts and the accessories at a temperature not greater than 40 °C/104 °F and clean them. Remove the battery cover and dry the battery compartment. Do not repack until everything is dry. Always close the transport container when using in the field.

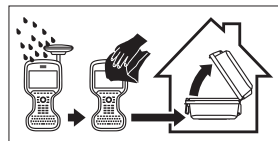

Cables and plugs

Keep plugs clean and dry. Blow away any dirt lodged in the plugs of the connecting cables.

Connectors with dust caps

Wet connectors must be dry before attaching the dust cap.

DISTO window

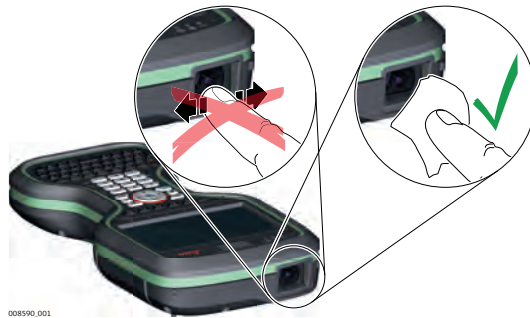

6 Technical Data

6.1 CS20

Design Polymer housing with optional integrated battery and radio modem.

Control unit

Type	Description
Display	5", WVGA (800 x 480 pixels), graphics capable LCD, illumination, touch screen, colour
Keyboard	67 keys including 12 function keys
Touch technology	Resistive
Sound	Integrated sealed speaker and microphone
Digital camera	Resolution: 2592 x 1944 pixels, 5 MP, fixed focus lens, image capture: JPEG, flash
DISTO	Range: 150 m Accuracy: ± 1 mm + 0.2 mm/m Resolution of view finder camera: 1600 x 1200 pixels, 2 MP

Dimensions



Weight

Type	Weight [kg]/[lbs]
CS20 Basic	1.115/2.458
CS20 LTE	1.190/2.623
CS20 LTE DISTO	1.225/2.700

Memory devices

Data can be stored on the SD card, USB stick or in the internal memory.

Power

Type	Consumption [A]	External supply voltage
CS20	2.2	Nominal voltage: 15 V DC (---) Voltage range: 10.5 V DC to 18.0 V DC Minimum voltage for charging: 14 V DC (---)

Internal battery

Type	Battery	Voltage	Capacity	Operating time, typical*
CS20	Li-Ion	11.1 V	GEB331: 2.8 Ah	8 h

* Operating time depends on use of wireless communication devices.

Environmental specifications**Temperature**

Type	Operating temperature [°C]	Storage temperature [°C]
CS20	-30 to +60*	-40 to +80
GEB331	-30 to +60	-40 to +70
GS07	-40 to +65	-40 to +80

* The operating temperature of the DISTO module is -10° C to +50° C. Outside of these limits, the module will be switched off automatically and a warning message will be displayed.

Protection against water, dust and sand

Protection	
Instrument	GS07: IP66 & IP68 (IEC 60529) CS20: IP68 (IEC 60529)  CS20 is in compliance with IP68 only when expansion cover, connector cover and battery cover are closed. Dust tight Protected against continuous immersion in water Tested for 2 hours in 1.40 m depth
GEB331	IP54 (IEC 60529) Dust protected Protection against splashing water from any direction

Humidity

Protection	
Instrument	Up to 95 %. The effects of condensation are to be effectively counteracted by periodically drying out the instrument.
GEB331	For indoor use only

Interfaces

Type	RS232	USB Host	USB Client	Bluetooth	WLAN
CS20	LEMO port	USB2.0 Host (A)	LEMO USB client (high-speed)	Class 1	802.11b/g/n

Data format for RS232

The default values are:

Baud rate:	115200	Data bits:	8
Parity:	None	Stop bits:	1
Terminator:	CR/LF		

Ports

Type	8 pin LEMO-1	USB2.0 Host (A)	LEMO USB client (high-speed)
CS20	For power and/or communication	For communication	

6.2

GS07

6.2.1

Tracking Characteristics

Satellite reception

Multi-frequency

Instrument channels



Depending on the satellite systems and signals configured, a maximum number of 320 channels is allocated.

Supported signals

System	Signal
GPS	L1, L2, L2C, L5
GLONASS	L1, L2, L3*
Galileo	E1, E5a, E5b, AltBOC, E6*
BeiDou	B1, B2, B3*
QZSS	L1 C/A, L2C, L5
SBAS (WAAS, EGNOS, MSAS, GAGAN)	L-band

* Believe to comply, but subject to availability of BeiDou Interface Control Document and Galileo commercial service definition.



Carrier phase and code measurements on L1, L2 and L5 (GPS) are fully independent with AS on or off.

6.2.2

Accuracy



Accuracy is dependent upon various factors including the number of satellites tracked, constellation geometry, observation time, ephemeris accuracy, ionospheric disturbance, multipath and resolved ambiguities.

The following accuracies, given as **root mean square**, are based on measurements processed using Infinity and on real-time measurements.

The use of multiple GNSS systems can increase accuracy by up to 30% relative to GPS only.

Differential code

The baseline precision of a differential code solution for static and kinematic surveys is 25 cm.



The measurement of accuracy is compliant with ISO 17123-8.

Differential phase in post-processing

Type	Horizontal	Vertical
Static and rapid static	5 mm + 0.5 ppm	10 mm + 0.5 ppm
Kinematic	10 mm + 1 ppm	20 mm + 1 ppm
Static with long observations	3 mm + 0.5 ppm	6 mm + 0.5 ppm

Differential phase in real-time

Type	Horizontal	Vertical
Single Baseline (<30 km)	10 mm + 1 ppm	20 mm + 1 ppm
Network RTK	10 mm + 0.5 ppm	20 mm + 0.5 ppm

6.2.3

Technical Data

Dimensions

Type	Height	Diameter
GS07	0.071 m	0.186 m

Connector

8 pin LEMO-1

Mounting

5/8" Whitworth

Weight

0.8 kg including internal battery

Power

Type	Description
Power consumption	2.0 W typically
External supply voltage	Nominal 12 V DC (---), voltage range 10.5 V-28 V

Battery internal

Type	Battery	Voltage	Capacity	Operating time, typically*
GEB212	Li-Ion	7.4 V	2.6 Ah	7 h

- * The given operating times are valid for
- one fully charged GEB212 battery.
 - 25°C. Operating times will be shorter when working in cold weather.

Electrical data

Type	GS07
Voltage	-
Current	-
Frequency	
GPS L1 1575.42 MHz	✓
GPS L2 1227.60 MHz	✓
GPS L5 1176.45 MHz	✓
GLONASS L1 1602.5625-1611.5 MHz	✓
GLONASS L2 1246.4375-1254.3 MHz	✓
Galileo E1 1575.42 MHz	✓
Galileo E5a 1176.45 MHz	✓
Galileo E5b 1207.14 MHz	✓
Galileo AltBOC 1191.795 MHz	✓
BeiDou B1 1561.098 MHz	✓
BeiDou B2 1207.14 MHz	✓
Gain	Typically 37 dBi
Noise Figure	Typically < 3 dBi

Environmental specifications

Temperature

Operating temperature [°C]	Storage temperature [°C]
-40 to +65	-40 to +80
Bluetooth: -30 to +65	

Protection against water, dust and sand

Protection
IP66 & IP68 (IEC 60529)
Dust-tight
Protected against water jets
Protected against continuous immersion in water
Tested for 2 h in 1.40 m depth

Humidity

Protection
Up to 95 %
The effects of condensation are to be effectively counteracted by periodically drying out the antenna.

6.3

Conformity to National Regulations

6.3.1

Products without Radio

Conformity to national regulations

- For products without radio transmitter or receiver:
- FCC Part 15 (applicable in US)



- Hereby, Leica Geosystems AG declares that the product/s is/are in compliance with the essential requirements and other relevant provisions of the applicable European Directives.
The full text of the EU declaration of conformity is available at the following Internet address:
<http://www.leica-geosystems.com/ce>.

6.3.2

CS20

Conformity to national regulations

- FCC Part 15, 22 and 24 (applicable in US)
 - Hereby, Leica Geosystems AG declares that the radio equipment type CS20 is in compliance with Directive 2014/53/EU and other applicable European Directives.
The full text of the EU declaration of conformity is available at the following Internet address: <http://www.leica-geosystems.com/ce>.
-  Class 1 equipment according to European Directive 2014/53/EU (RED) can be placed on the market and be put into service without restrictions in any EEA member state.
- The conformity for countries with other national regulations not covered by the FCC part 15, 22 and 24 or European Directive 2014/53/EU has to be approved prior to use and operation.

Conformity to national regulations



Applicant name: Leica Geosystems Korea AG
 Product name: Specific small output wireless device
 Model name: CS20 LTE
 KC number: R-R-rks-CS20LTE
 Manufacture date: Marked separately
 Manufacturer: LEICA GEOSYSTEMS/SWITZERLAND

Frequency band

For CS20 with PLAS9-X modem (876479, 876480)

Type	Frequency band [MHz]	
CS20, Bluetooth	2402 - 2480	
CS20, RCS	2402 - 2480	
CS20 Cellular (GSM (2G)/ UMTS (3G)/ LTE (4G))	GSM	850 / 900 / 1800 / 1900
	UMTS	850 / 1700 / 1900
	LTE	700 / 850 / 1700 / 1900
	LTE Download	300 Mbit/s
	LTE Upload	50 Mbit/s
	HSPA+ Download	42 Mbit/s
	HSPA Upload	5.76 Mbit/s
CS20, WLAN	2400 - 2484	

For CS20 with PLAS9-W modem (876477, 876478)

Type	Frequency band [MHz]	
CS20, Bluetooth	2402 - 2480	
CS20, RCS	2402 - 2480	

Type	Frequency band [MHz]	
CS20 Cellular (GSM (2G)/ UMTS, TD-SCDMA (3G)/ LTE (4G))	GSM	900 / 1800
	UMTS	850 / 900 / 1800 / 2100
	TD-SCDMA	1900 / 2000
	LTE (FDD)	700 / 800 / 850 / 900 / 1800 / 2100 / 2600
	LTE (TDD)	1900 / 2300 / 2600
	LTE Download	300 Mbit/s
	LTE Upload	50 Mbit/s
	HSPA+ Download	42 Mbit/s
	HSPA Upload	5.76 Mbit/s
CS20, WLAN	2400 - 2484	

Output power

CS20 (876476)

Type	Output power [mW]
CS20, Bluetooth	10
CS20	< 20
CS20, WLAN (802.11b) - 11 Mbit/s	100
CS20, WLAN (802.11g) - 54 Mbit/s	80
CS20, WLAN (802.11n) - 65 Mbit/s	80

For PLAS9-X (876479, 876480)

Type	Output power [mW]
CS20, Bluetooth	10
CS20	< 20
CS20, Cellular (2G) EGSM850/900	2000
CS20, Cellular (2G) GSM1800/1900	1000
CS20, Cellular (2G) EDGE850/900	500
CS20, Cellular (2G) EDGE1800/1900	400
CS20, Cellular (3G) UMTS850	250
CS20, Cellular (3G) UMTS1700	250
CS20, Cellular (3G) UMTS1900	250
CS20, Cellular (4G) LTE700	200
CS20, Cellular (4G) LTE850	200
CS20, Cellular (4G) LTE1700	200
CS20, Cellular (4G) LTE1900	200
CS20, WLAN (802.11b) - 11 Mbit/s	100
CS20, WLAN (802.11g) - 54 Mbit/s	80
CS20, WLAN (802.11n) - 65 Mbit/s	80

For PLAS9-W (876477, 876478)

Type	Output power [mW]
CS20, Bluetooth	10
CS20	< 20
CS20, Cellular (2G) EGSM900	2000
CS20, Cellular (2G) GSM1800	1000
CS20, Cellular (2G) EDGE900	500
CS20, Cellular (2G) EDGE1800	400
CS20, Cellular (3G) UMTS850/900	250
CS20, Cellular (3G) UMTS1800/2100	250
CS20, Cellular (3G) TD-SCDMA1900/2000	250
CS20, Cellular (4G) FDD LTE700/800/850	200
CS20, Cellular (4G) FDD LTE1800/2100	200
CS20, Cellular (4G) FDD LTE2600	200
CS20, Cellular (4G) TDD LTE1900	200
CS20, Cellular (4G) TDD LTE2300/2600	200
CS20, WLAN (802.11b) - 11 Mbit/s	100
CS20, WLAN (802.11g) - 54 Mbit/s	80
CS20, WLAN (802.11n) - 65 Mbit/s	80

Antenna

Type	Antenna	Gain [dBi]	Con- nector	Frequency band [MHz]
CS20, Bluetooth	Integrated antenna	2	-	2400-2480
CS20, RCS	Integrated antenna	1	-	2400-2480
CS20, GSM (2G)/ UMTS (3G)/LTE (4G) (for PLAS9-X (876479, 876480))	Integrated antenna	-	-	-
CS20, GSM (2G)/ UMTS, TD- SCDMA (3G)/LTE (4G) (for PLAS9-W (876477, 876478))	Integrated antenna	-	-	-
CS20, WLAN	Integrated antenna	1	-	2400-2480

Conformity to national regulations

- FCC Part 15 (applicable in US)
- Hereby, Leica Geosystems AG declares that the radio equipment type GS07 is in compliance with Directive 2014/53/EU and other applicable European Directives.
The full text of the EU declaration of conformity is available at the following Internet address: <http://www.leica-geosystems.com/ce>.



Class 1 equipment according to European Directive 2014/53/EU (RED) can be placed on the market and be put into service without restrictions in any EEA member state.

- The conformity for countries with other national regulations not covered by the FCC part 15 or European Directive 2014/53/EU has to be approved prior to use and operation.
- Japanese Radio Law and Japanese Telecommunications Business Law Compliance.
 - This device is granted pursuant to the Japanese Radio Law (電波法) and the Japanese Telecommunications Business Law (電気通信事業法).
 - This device should not be modified (otherwise the granted designation number will become invalid).

Frequency band

Type	Frequency band [MHz]
GS07	2402 - 2480
GNSS	1227.60 1575.42 1246.4375 - 1254.3 1602.4375 - 1611.5
Bluetooth	2402 - 2480

Output power

Type	Output power [mW]
GS07	< 100 mW (e. i. r. p.)
GNSS	Receive only
Bluetooth	5 (Class 1)

Antenna

Type	Antenna	Gain [dBi]	Connector	Frequency band [MHz]
GS07	$\lambda/2$ antenna	2 max.	SMB (internal)	-
GNSS	Internal GNSS antenna element (receive only)	-	-	-
Bluetooth	Internal Microstrip antenna	1.0 dBi	-	-

6.3.4

CTR20

Conformity to national regulations

- FCC Part 15 (applicable in US)
- Hereby, Leica Geosystems AG declares that the radio equipment type CTR20 is in compliance with Directive 2014/53/EU and other applicable European Directives.

The full text of the EU declaration of conformity is available at the following Internet address: <http://www.leica-geosystems.com/ce>.



Class 1 equipment according to European Directive 2014/53/EU (RED) can be placed on the market and be put into service without restrictions in any EEA member state.

- The conformity for countries with other national regulations not covered by the FCC part 15 or European Directive 2014/53/EU has to be approved prior to use and operation.

Frequency band

Type	Frequency band
CTR20	2402 - 2480
GNSS	1227.60 1575.42 1246.4375 - 1254.3 1602.4375 - 1611.5
Bluetooth	2402 - 2480

Output power

Type	Output power [mW]
CTR20	< 100 mW (e. i. r. p.)
GNSS	Receive only
Bluetooth	5 (Class 1)

Antenna

Type	Antenna	Gain [dBi]	Connector	Frequency band [MHz]
CTR20	$\lambda/2$ antenna	2 max.	SMB (internal)	-
GNSS	Internal GNSS antenna element (receive only)	-	-	-
Bluetooth	Internal Microstrip antenna	1.0 dBi	-	-

6.3.5

CGR4

Conformity to national regulations

- FCC Part 15 (applicable in US)
- Hereby, Leica Geosystems AG declares that the radio equipment type CGR4 is in compliance with Directive 2014/53/EU and other applicable European Directives.

The full text of the EU declaration of conformity is available at the following Internet address: <http://www.leica-geosystems.com/ce>.

- This Class 2 equipment may be operated in: AT, BE, BG, CA, CH, CY, CZ, DE, DK, EE, ES, FI, FR, GB, GR, HU, IE, IS, IT, LT, LU, LV, MT, NL, NO, PL, PT, RU, RO, SE, SI, SK, US.



Class 2 equipment according to European Directive 2014/53/EU (RED) for which following EEA Member States apply restrictions on the placing on the market or on the putting into service or require authorisation for use:

- *France*
 - *Italy*
 - Norway (if used in the geographical area within a radius of 20 km from the centre of Ny-Ålesund)
- The conformity for countries with other national regulations not covered by the FCC part 15 or European Directive 2014/53/EU has to be approved prior to use and operation.

Frequency band

403 - 473 MHz

Output power

Receive only radio

Antenna

Type	Gain	Connector
$\lambda/2$ antenna	0 dBi maximal	SMB (internal)

Software Licence Agreement

This product contains software that is preinstalled on the product, or that is supplied to you on a data carrier medium, or that can be downloaded by you online according to prior authorisation from Leica Geosystems. Such software is protected by copyright and other laws and its use is defined and regulated by the Leica Geosystems Software Licence Agreement, which covers aspects such as, but not limited to, Scope of the Licence, Warranty, Intellectual Property Rights, Limitation of Liability, Exclusion of other Assurances, Governing Law and Place of Jurisdiction. Please make sure, that at any time you fully comply with the terms and conditions of the Leica Geosystems Software Licence Agreement.

Such agreement is provided together with all products and can also be referred to and downloaded at the Leica Geosystems home page at <http://leica-geosystems.com/about-us/compliance-standards/legal-documents> or collected from your Leica Geosystems distributor.

You must not install or use the software unless you have read and accepted the terms and conditions of the Leica Geosystems Software Licence Agreement. Installation or use of the software or any part thereof, is deemed to be an acceptance of all the terms and conditions of such Licence Agreement. If you do not agree to all or some of the terms of such Licence Agreement, you must not download, install or use the software and you must return the unused software together with its accompanying documentation and the purchase receipt to the distributor from whom you purchased the product within ten (10) days of purchase to obtain a full refund of the purchase price.

Open Source information

The software on the product may contain copyright-protected software that is licenced under various open source licences.

Copies of the corresponding licences

- are provided together with the product (for example in the About panel of the software)
- can be downloaded on <http://opensource.leica-geosystems.com>

If foreseen in the corresponding open source licence, you may obtain the corresponding source code and other related data on <http://opensource.leica-geosystems.com>.

Contact

opensource@leica-geosystems.com in case you need additional information.

Appendix A

Pin Assignments and Sockets

A.1

CS20

Description

Some applications require knowledge of the pin assignments for the instrument ports.

In this chapter, the pin assignments and sockets for the instrument ports are explained.

Ports at the instrument bottom panel - LEMO connector

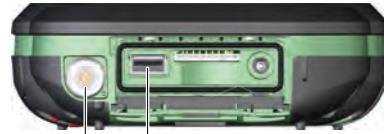

008379.001

- a LEMO port (USB and serial)
- b USB A Host port

Pin assignments for 8 pin LEMO-1

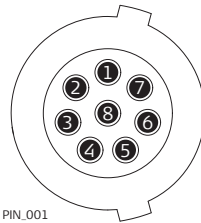

PIN_001

Pin	Signal Name	Function	Direction
1	USB_D+	USB data line	In or out
2	USB_D-	USB data line	In or out
3	GND	Signal ground	-
4	RxD	RS232, receive data	In
5	TxD	RS232, transmit data	Out
6	ID	Identification pin	In or out
7	PWR	Power input, 10.5 V-18 V	In
8	GPIO	RS232, general purpose signal	In or out

A.2

GS07

Description

Some applications require knowledge of the pin assignments for the instrument ports.

In this chapter, the pin assignments and sockets for the instrument ports are explained.

Ports at the instrument underside



0016302.001

a Lemo port (USB and serial)

Pin assignments for 8 pin LEMO-1

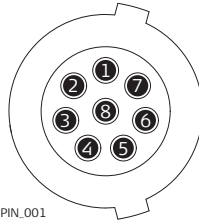

PIN_001

Pin	Signal Name	Function	Direction
1	USB_D+	USB data line	In or out
2	USB_D-	USB data line	In or out
3	GND	Signal ground	-
4	RxD	RS232, receive data	In
5	TxD	RS232, transmit data	Out
6	NC	Not connected	-
7	PWR	Power input, 10.5 V–28 V	In
8	AUX_ON	RS232, manual PWR switch	In

870196-2.3.0en

Original text (870196-2.3.0en)

Printed in Switzerland

© 2020 Leica Geosystems AG, Heerbrugg, Switzerland



- when it has to be **right**

Leica
Geosystems

Leica Geosystems AG

Heinrich-Wild-Strasse

CH-9435 Heerbrugg

Switzerland

Phone +41 71 727 31 31

www.leica-geosystems.com

