



CE MODELS | SJ 6826 RT SJ 6832 RT



COMPACT SERIES Rough Terrain SCISSOR LIFTS

Skyjack's Compact Series Rough Terrain Scissor Lifts offer the same industry leading rugged, robust, and reliable scissor lifts that have made Skyjack famous.

The SJ 6826RT and SJ6832RT both come equipped with an exclusive cross over symmetrical 4WD system for superior traction. Featuring up to 50% gradeability, these machines can operate on any job site terrain.

Standard features also include an easy to use 1,5 m roll out extension deck, which can be secured in multiple positions for increased platform space and improved reach capabilities.

Both Compact models are drivable at full height with the roll out deck fully extended. A low stowed height is ideal for loading and unloading tools and materials.

Consistent with Skyjack's robust and reliable design features, the Compact Series Rough Terrain Scissor Lifts utilize Skyjack's standard colour coded and numbered wiring system with analog based controls.



COMPACT SERIES

Rough Terrain Scissor Lifts

Specifications	SJ6826 RT	SJ6832 RT
A Work Height	9,9 m	11,8 m
B Raised Platform Height	7,9 m	9,8 m
C Lowered Platform Height	1,2 m	1,4 m
D Overall Width	1,7 m	1,7 m
E Overall Length	2,7 m	2,7 m
F Stowed Height (Rails Up)	2,4 m	2,5 m
G Stowed Height (Rails Down)	1,6 m	1,8 m
H Platform Width (Inside Dimension)	1,4 m	1,4 m
I Platform Length (Inside Dimension)	2,4 m	2,4 m
Deck Extension	1,5 m	1,5 m
Ground Clearance	0,2 m	0,2 m
Wheelbase	2,0 m	2,0 m
Weight	2903 kg	3475 kg
Gradeability	50%	40%
Turning Radius (Inside)	1,5 m	1,5 m
Turning Radius (Outside)	4,0 m	4,0 m
Lift Time (With Rated Load)	36 sec	39 sec
Drive Speed (Stowed)	6,1 km/h	6,1 km/h
Drive Speed (Raised)	0,6 km/h	0,6 km/h
Maximum Drive Height	Full Height	Full Height
Capacity (Overall)	567 kg	454 kg
Maximum # of Persons	4	2

STANDARD FEATURES

- Drivable at full height with roll out deck fully extended
- Crossover symmetrical 4WD
- Multiple wet disc spring applied hydraulic release brakes
- 1,5 m roll out extension deck
- 24hp Kubota Diesel engine
- 90° swing out engine tray
- Analog control system
- Colour coded and numbered wiring system
- Up to 50% Gradeability
- Foam-filled low profile grip lug tyres
- Wiring for AC outlet on platform
- Tilt alarm with drive & lift cut-out
- All motion audible alarm
- Overload sensing system
- Lowering warning system
- Operator horn
- Hinged railing system
- Full height spring hinged gate at rear of unit
- Lanyard attachment point
- Scissor guards
- Forklift pockets and tie down/lift lugs

OPTIONS†

- Diesel scrubber
- Independent/auto leveling outriggers
- Flashing light
- Shop airline to platform
- 2.0kW hydraulic generator
- Foam-filled non marking tyres (6826RT only)
- Solid rubber non marking tyres

† Capacities, and machine weights may differ when options are added

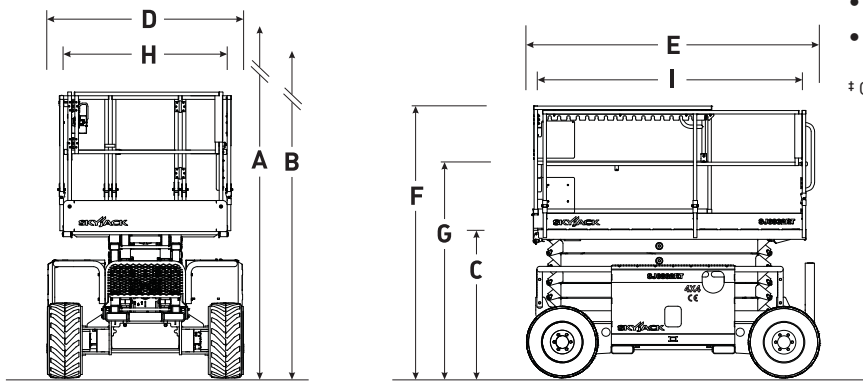

Skyjack UK

Unit 1, Maes-y-Clawdd
 Maesbury Road Industrial Estate
 Oswestry, Shropshire, SY10 8NN
 Phone: +44-1691-676235
 Fax: +44-1691-676239
 Email: info@skyjackeurope.co.uk

www.skyjack.com

This brochure is for illustrative purpose only and based on the latest information at the time of printing. Skyjack Inc. reserves the right to make changes at any time, without notice, to specifications, standard and optional equipment. Consult the Operating Maintenance and Parts Manuals for proper procedures. CE marked work platforms are in conformance to the Machinery Directive 98/37/EC.