

# ARRI

---

## ARRIFLEX 235

### Instruction Manual

As of: May 2005

ALL ARTWORK, PICTURES AND TEXTS ARE COVERED BY OUR COPYRIGHT.

THEY MUST NOT BE COPIED (E.G. ON CD-ROM, DISKS OR INTERNET-SITES) OR USED IN THEIR ENTIRE FORM OR IN EXCERPTS WITHOUT OUR PREVIOUS WRITTEN AGREEMENT.

IF YOU ARE DOWNLOADING PDF-FILES FROM OUR INTERNET HOMEPAGE FOR YOUR PERSONAL USE, MAKE SURE TO CHECK FOR UPDATED VERSIONS.

WE CANNOT TAKE ANY LIABILITY WHATSOEVER FOR DOWNLOADED FILES, AS TECHNICAL DATA ARE SUBJECT TO CHANGE WITHOUT NOTICE.

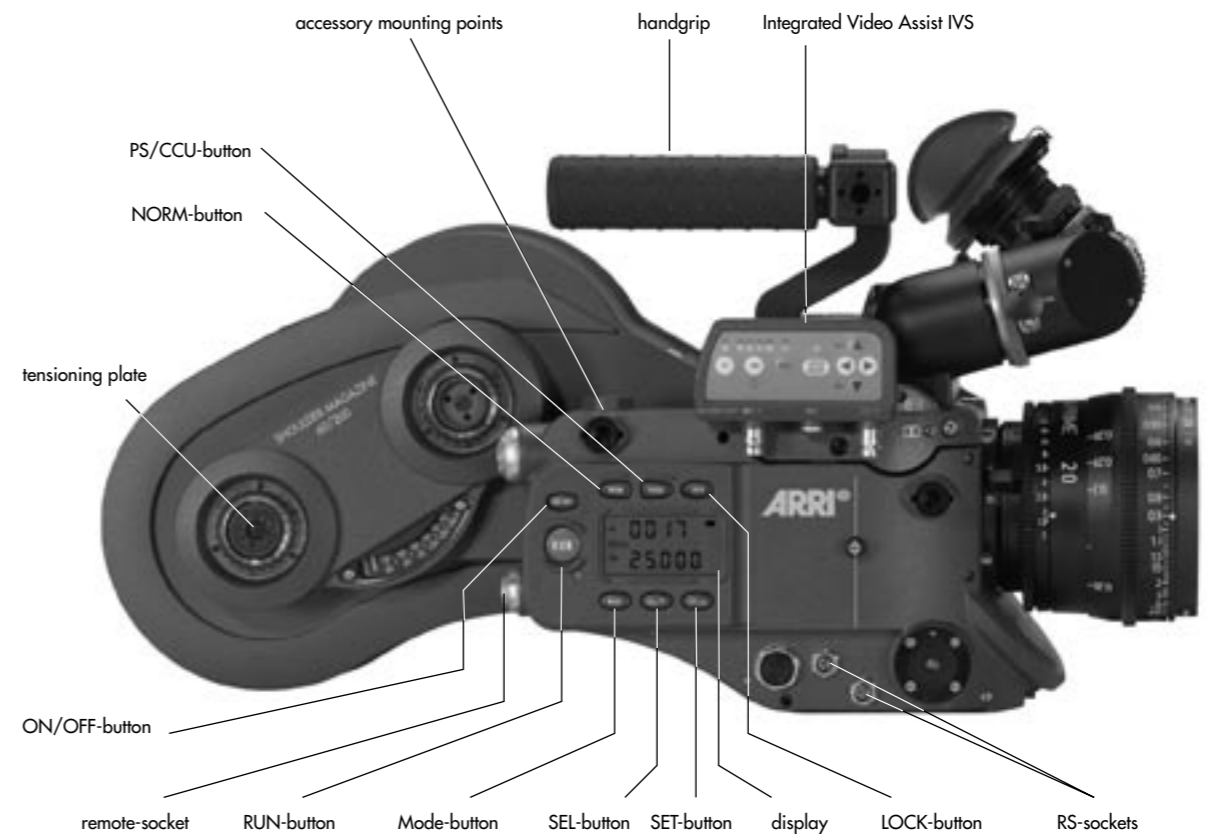
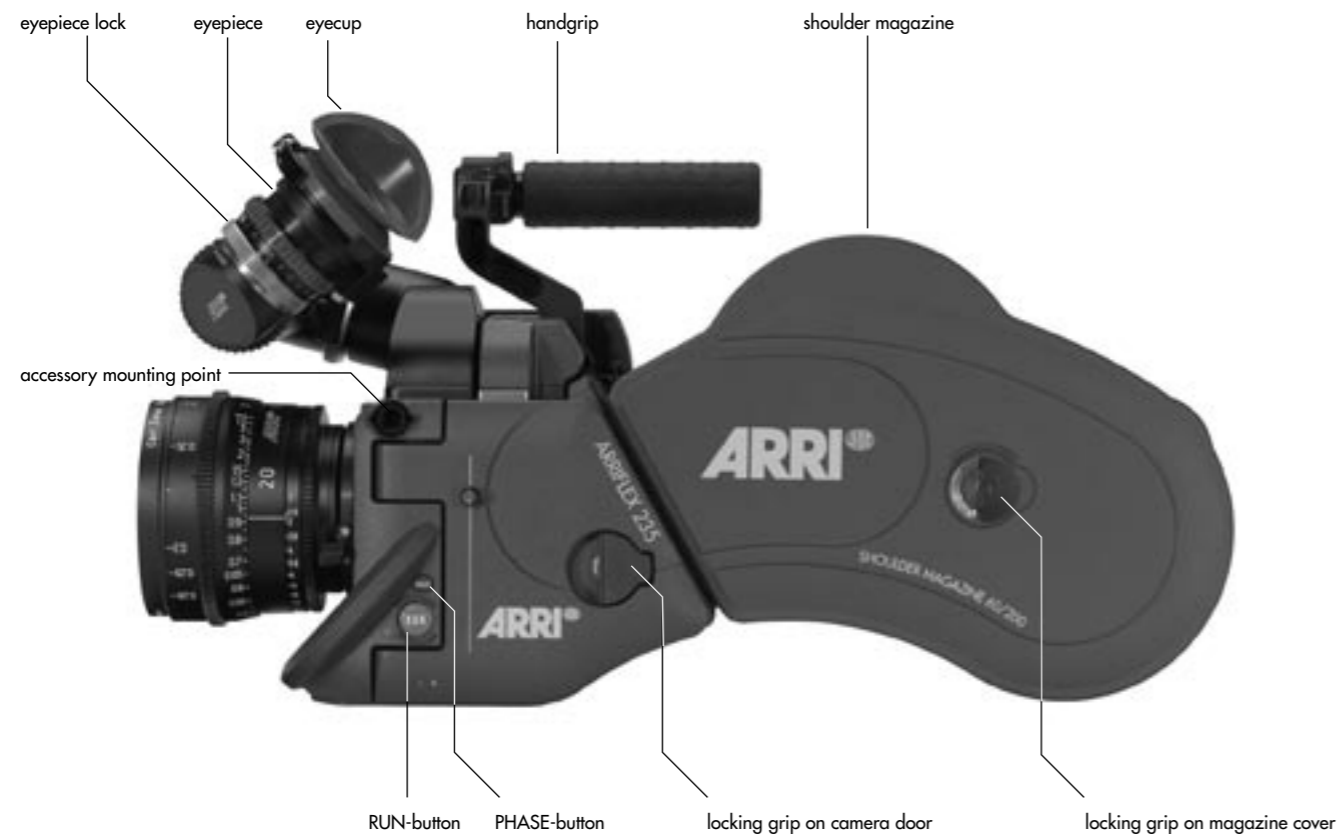
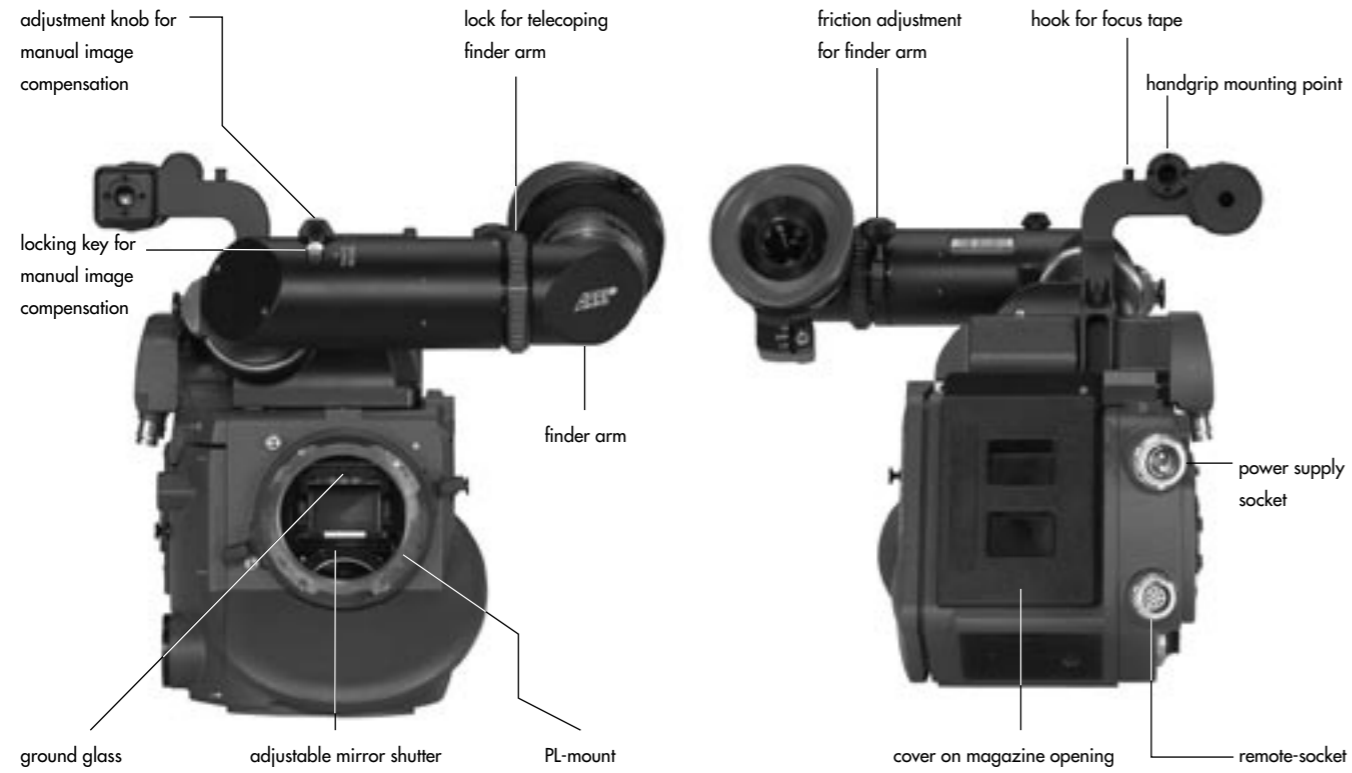

# 1. Contents

<b>2. Safety Instructions and Legal Disclaimer</b> ..7	<b>5. Power Supply</b> ..... 25
2.1. Safety Instructions .....7	5.1 Battery NC 24/7 R ..... 26
Warning signs .....7	5.2 Charger NCL 24 R ..... 26
General safety instructions .....7	5.3 Mains Unit NG 12/24 R ..... 27
Specific safety instructions ..... 9	5.4 Mains Unit NG 12/26 R ..... 27
2.2 Disclaimer ..... 10	5.5 Accessory Power Supply ..... 28
	24 V Accessories ..... 28
<b>3. General Description of the ARRIFLEX 235</b> .. 13	<b>6. Magazines</b> ..... 29
<b>4. Installation of the Camera</b> ..... 15	6.1 Loading the Shoulder Magazine ..... 30
4.1 Packing and Transport ..... 15	6.2 Removing Exposed Film ..... 34
4.2 Tripod Heads ..... 15	6.3 Transport and Storage ..... 35
4.3 Riser Plate ..... 16	<b>7. Camera Body</b> ..... 37
Attaching the Riser Plate ..... 16	7.1 Mechanically Adjustable Mirror Shutter ..... 37
4.4 Bridge Plates BP-8, BP-9 ..... 16	Setting the Mirror Shutter Angle ..... 37
Attaching the Bridge Plate to the Camera ..... 17	Shutter Angle Measurement ..... 38
Removing the Camera from the Tripod ..... 18	Filming with HMI Light ..... 39
4.5 Lens Support ..... 19	7.2 Exchanging the Ground Glass ..... 40
4.6 Grip System ..... 20	7.3 Movement ..... 41
Standard Camera Handle ..... 20	7.4 Attaching the Magazine, Threading the Film ..... 42
Low Mode Handle ..... 21	7.5 Removing the Magazine ..... 45
Low Mode Support LMS-1 ..... 22	
Side Bracket SBR-1 ..... 23	
4.7 Operation from the Shoulder ..... 24	

<b>8. Optics</b> .....	47	<b>10. Video-Assist-System</b> .....	67
8.1 Lenses .....	47	10.1 General Description of the IVS .....	67
8.2 Viewfinder System .....	48	Main Features .....	67
The Eyepiece .....	48	10.2 Setup .....	70
Adjusting the Viewfinder .....	49	10.2.1 Installation .....	70
Image Compensation.....	50	10.2.2 Cabling .....	72
<b>9. Camera Operation</b> .....	53	10.3 Standard Video Controls .....	79
9.1 Main Camera Switch .....	53	10.3.1 Switch On, Off and Check/Hide Menu .....	79
9.2 Running and Stopping the Camera .....	53	10.3.2 Mechanical Iris .....	80
Running the Camera .....	53	10.3.3 Alignment of the image position (X-, Y- and Rotation) and focus .....	81
Stopping the Camera.....	54	10.3.4 White Balance (WB) .....	82
Inching .....	55	10.3.5 Gain Control .....	86
9.3 Displaying and Setting Operational Parameters .....	55	10.3.6 Flicker free on/off .....	89
Overview of Display Modes .....	56	10.3.7 Changing Format marking number .....	91
Overview of Display Symbols .....	57	10.3.8 Storing a video image .....	93
Display: Movement Open.....	57	10.4 Inserter Facilities .....	95
Film Counter .....	58	10.4.1 Setting the On-Screen Displays .....	95
Displaying the Angle of the Mirror Shutter (Mode 1) ...	59	10.4.2 Main Menu .....	97
Frame Rates .....	60	10.4.3 Load/Store Menu .....	98
Shifting Phase .....	62	10.4.4 White Balance (WB) and Manual Gain Control (MGC) Menu .....	102
Displaying the Power Supply Voltage (Mode 3) ...	63	10.4.5 Video and Text Adjustment Menu .....	108
Setting the brightness of the button illumination ...	63	10.4.6 Format Marking Menu .....	114
Switching On and Off the Warning Signal for Asynchronous Running (Mode 4) .....	64	10.4.7 Compare/Store Menu .....	119
Setting the Volume of the Warning Signal .....	64	10.4.8 System and Status Menu .....	122
Mode 5 .....	65	10.4.9 User Text Menu .....	128

<b>11. Accessories</b> .....	135	<b>14. Appendix</b> .....	155
Accessory Mounting Points .....	135	Loose Film Loops in the Magazine.....	155
Universal Viewfinder UV-1 .....	136	Fuses .....	155
Adjusting the UV-1 .....	136	<b>15. Technical Data</b> .....	161
Work Light WL-3 .....	137	<b>16. Order Numbers</b> .....	163
Heated Eyecup HE-4 .....	137	<b>17. ARRI Service</b> .....	165
Remote Run Switch RS-4 .....	138	<b>18. Index</b> .....	167
External Synchronization Unit ESU-1 .....	139		
Remote Control Unit RCU-1 .....	140		
Wireless Remote Control WRC-1 .....	143		
<b>12. Super 35</b> .....	145		
Converting the Lens Mount Receptacle to Normal 35 ...	145		
Converting the Bridge Plate to Super 35 .....	146		
<b>13. Maintenance</b> .....	147		
Camera .....	148		
Cleaning the Film Gate .....	148		
Cleaning the Spacer Gate .....	150		
Cleaning the Field Lens .....	151		
Magazine .....	152		
Cleaning the Throat Assembly .....	152		
Setting Friction on the Shoulder Magazine.....	152		



## 2. Safety Instructions and Legal Disclaimer

### 2.1. Safety Instructions



*Please always follow these instructions to help ensure against injury to yourself and damage to the system or other objects.*

*This safety information is additional to the product-specific operating instructions in general and must be strictly observed for safety reasons. They are no substitute to settled down your own safety measures.*

#### Warning signs



*Possible risk of injury or damage to equipment.*



*This symbol indicates the risk of electric shock or fire danger that could result in injury or equipment damage.*

#### General safety instructions



*Read and understand all safety and operating instructions before you operate or install the system.*



*Retain all safety and operating instructions for future reference.*



*Heed all warnings on the system and in the safety and operating instructions before you operate or install the system. Follow all installation and operating instructions.*



*Do not use accessories or attachments not recommended by ARRI, as they may cause hazards and void the warranty.*



*Do not repair any part of the system. Repairs must only be carried out by authorized ARRI repair shops.*



*Do not remove any safety measure of the system.*



*Do not operate the system in high humidity areas or expose it to water or moisture.*



*Do not place the system on an unstable cart, stand, tripod, bracket, or table. The system may fall, causing serious personal injury and damage to the system or other objects.*



*Operate the system using only the type of power source indicated in the manual. Unplug the power cord by gripping the power plug, not the cord.*



*Never insert objects of any kind into any part of the system through openings, as the objects may touch dangerous voltage points or short out parts. This could cause fire or electrical shock.*



*Unplug the system from the power outlet before opening any part of the system or before making any changes on the system, especially the attaching or removing of cables.*



*Do not use solvents to clean.*



*Clean optical surfaces only with a lens brush or a clean lens cloth! In case of solid dirt moisten a lens cloth with pure alcohol.*



*Do not loosen any screws which are painted over!*



## Specific safety instructions



*Never run the camera without a lens or a protective cap in the lens mount receptacle!*



*Never operate the movement locking mechanism while the camera is running!*



*As the end-stops of the iris ring on the ARRIMACROS change when the lens is focussed, the ARRIMACROS may not be used with the ARRI Wireless Remote System (WRS) or the Lens Control System (LCS).*



*Danger of injury with rotating drive gears on the lens barrel, or when switching the operating direction on the UMC-1 and UMC-3!*

Any violation of these safety instructions or the non-observance of personal care could cause serious injuries (including death) and damages to the system or other objects.

Note: Notes are used to indicate further information or information from other instruction manuals.

⇨ **photo** indicates objects which are shown in the illustration.

### Product Identification

When ordering parts or accessories, or if any questions should arise, please advise your type of product and serial number.

## 2.2 Disclaimer

Before using the products described in this manual be sure to read and understand all respective instructions. The ARRIFLEX 235 is only available for commercial customers. The customer grants by utilization, that the ARRIFLEX 235 or other components of the system are only deployed for commercial use. Otherwise the customer has the obligation to contact ARRI preceding the utilization.

While ARRI endeavors to enhance the quality, reliability and safety of their products, customers agree and acknowledge that the possibility of defects thereof cannot be eliminated entirely. To minimize risks of damage to property or injury (including death) to persons arising from defects in the products, customers must incorporate sufficient safety measures in their work with the system and have to heed the statuted canonic use.

No part of this document may be copied or reproduced in any form or by any means without prior written consent of ARRI. ARRI assumes no responsibility for any errors that may appear in this document. The information is subject to change without notice.

For actual design-in, refer to the latest publications of ARRI data sheets or data books, etc., for the most up-to-date specifications. Not all products and/or types are available in every country. Please check with an ARRI sales representative for availability and additional information.

Neither ARRI nor its subsidiaries assume any liability for infringement of patents, copyrights or other intellectual property rights of third parties by or arising from the use of ARRI products or any other liability arising from the use of such products. No license, express, implied or otherwise, is granted under any patents, copyrights or other intellectual property rights of ARRI or others.

ARRI or its subsidiaries expressly exclude any liability, warranty, demand or other obligation for any claim, representation, or cause, or action, or whatsoever, express or implied, whether in contract or tort, including negligence, or incorporated in terms and conditions, whether by statute, law or otherwise. In no event shall ARRI or its subsidiaries be liable for or have a remedy for recovery of any special, direct, indirect, incidental, or consequential damages, including but not limited to lost profits, lost savings, lost revenues or economic loss of any kind or for any claim by third party, downtime, good-will, damage to

or replacement of equipment or property, any costs or recovering of any material or goods associated with the assembly or use of our products, or any other damages or injury of persons and so on or under any other legal theory.

In the case one or all of the forgoing clauses are not allowed by applicable law, the fullest extent permissible clauses by applicable law are validated.

ARRI is a registered trademark of Arnold & Richter Cine Technik GmbH & Co Betriebs KG.

**Note:**

This product and the accessories recommended by the manufacturer fulfill the specifications of the EU-Guideline 89/336/EWG.



### 3. General Description of the ARRIFLEX 235

The ARRIFLEX 235 is a compact, lightweight MOS camera.

- Operational parameters can be set directly on the camera.
- The frame rates range from 1 – 60 fps for forward and 25 fps in reverse running.
- The ARRIFLEX 235 is equipped with a low-maintenance, 5-link movement with single transport claws and registration pins.
- The mechanically adjustable mirror shutter on the ARRIFLEX 235 can be set to 45°, 60°, 75°, 90°, 105°, 120°, 135°, 144°, 150°, 172,8° and 180°.
- The viewfinder can be rotated in two axes and can be used on both sides of the camera with full image compensation.
- A 1/2" CCD video camera can be attached directly to the camera body.
- The versatile grip system is connected directly to the camera body and can be used as a carrying handle or as an accessory holder.

A comprehensive range of optical, mechanical and electronic accessories further expands the operational possibilities of the camera.



## 4. Installation of the Camera

### 4.1 Packing and Transport



*In order to prevent damage to the mirror shutter, a protective cap must be on the lens mount receptacle at all times.*



*When transporting the camera, pay attention that the movement is in the locked position ⇨ **photo**.*



*If the ARRIFLEX 235 is transported or stored without a magazine, the magazine opening cover ⇨ **photo** should be attached.*



*Loaded or empty magazines should only be transported or stored with the loop protector ⇨ **photo** attached to avoid damage to the film stock and the magazine throat assembly.*

### 4.2 Tripod Heads

The following tripod heads are suitable for use with the ARRIFLEX 235:

- ARRIHEAD
- ARRIHEAD 2
- ARRIHEAD 2 with integrated encoders
- ARRI Fluid-Heads
- Sachtler Studio 7, 150 H
- Mitchell-Head
- Moy-Head
- Ronford F7
- Hot-Head
- Cam-Remote-Head
- Worall-Head



*In applications where the camera mount is subject to high forces (e.g. helicopter mounts) the camera must be additionally secured with retaining cords. All fastening screws must be tightened firmly with an appropriate screwdriver (not with the commonly used coin!).*

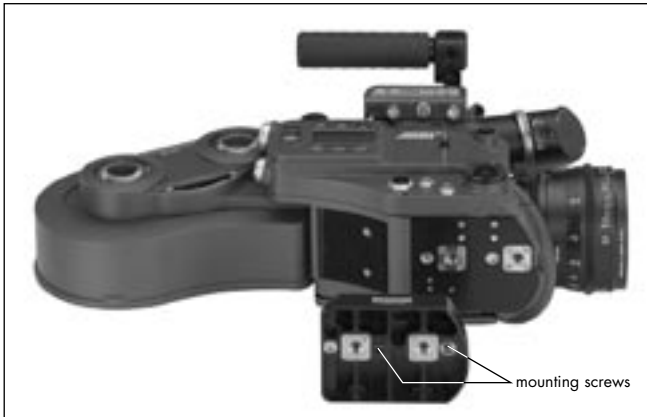

## 4.3 Riser Plate

To use the ARRIFLEX 235 together with a bridge plate on a tripod, it is necessary to bring the camera into the correct position to the support rods. To do this, a riser plate is mounted to the bottom of the camera onto which the bridgeplate can be mounted.

### Attaching the Riser Plate

- Fasten the riser plate with the two mounting screws ⇨ **photo** using a 5mm allen key. Both cylindrical pins must glide into the holes of the camera bottom.

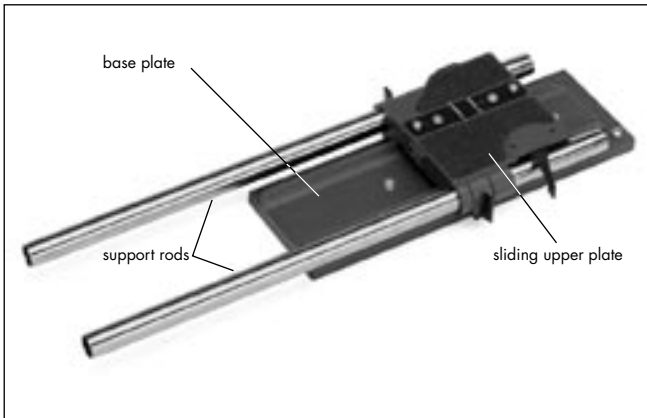

## 4.4 Bridge Plates BP-8, BP-9

The bridge plates facilitate balancing of the camera on the tripod and mounting of accessories. The BP-8 is designed for 19 mm support rods, the BP-9 for 15 mm support rods. The bridge plates consist of the base plate ⇨ **photo**, the sliding upper plate ⇨ **photo** and a pair of support rods ⇨ **photo**. In the standard version the support rods are 440mm long. Optionally, support rods are available in the lengths 240mm and 340mm.



**Note:** The upper plate of the bridge plate can be converted for use with Super 35. This ensures that the accessories are also exactly adapted to the displaced optical center of the Super 35 format. See also Chapter 12, Super 35.

## Attaching the Bridge Plate to the Camera

- Fasten the sliding upper plate ⇨ **photo** with the two slit screws to the camera base. Both cylindrical pins ⇨ **photo** (twist prevention) must glide into the holes.
- Then screw the base plate onto the wedge plate of the tripod and lock onto the tripod head.
- Slide the camera with the upper plate into the dovetail guide of the base plate until the spring-loaded stop pin ⇨ **photo** snaps back audibly. The camera's position can then be fixed with the clamping lever.
- Slide the support rods into the guides and clamp.
- Equip the camera with the required accessories to determine the center of gravity. Loosen the clamping lever ⇨ **photo**, and by sliding the camera on the base plate find the optimal position. Then retighten the clamping lever.

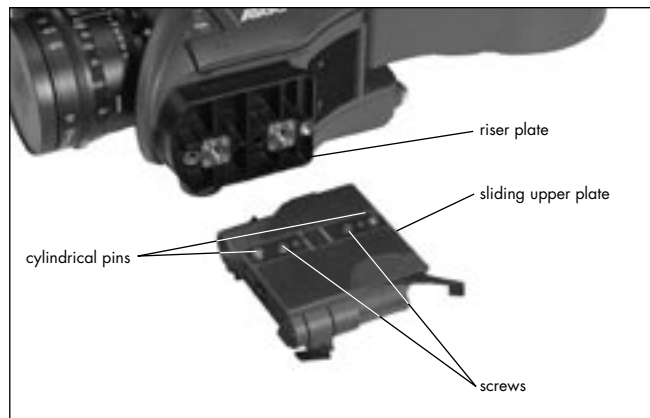

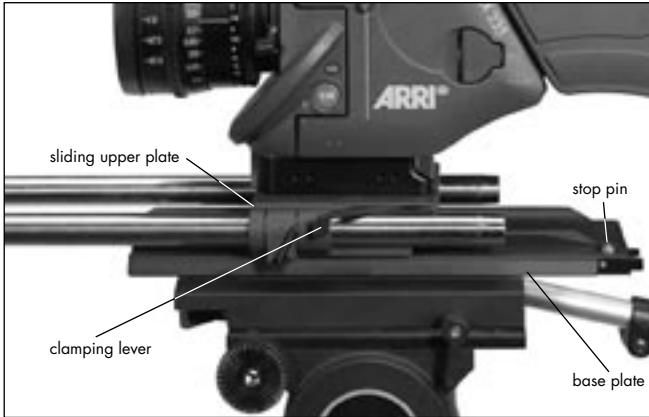

## Removing the Camera from the Tripod

- Before removing the camera make sure that all cables are disconnected and that the eyepiece leveling rod is detached.
- For fast removal of the camera from the tripod, loosen the clamping lever ⇨ **photo**, push in the stop pin ⇨ **photo** and then pull the camera with the upper plate ⇨ **photo** from the base plate.

## 4.5 Lens Support

The lens support consists of the lens support LS-7 (can be snapped onto 19 mm support rods) ⇨ **photo** or the lens support LS-8 (can be pushed onto 15 mm support rods) and the respective lens support ring ⇨ **photo** for the lens in use.

- Mount the lens support onto the support rods from above and let it click into place by applying slight pressure (push the LS-8 onto the support rods from the front).
- Slide the relevant support ring ⇨ **photo** onto the lens but do not tighten.
- Then slide the lens into the lens mount receptacle and lock.
- Connect the support ring to the lens support and tighten the knurled screw ⇨ **photo** as well as the clamping lever ⇨ **photo**.
- Complete the process by tightening the clamp screw ⇨ **photo** on the support ring.

**Note:** Mounting the support ring on the relevant lens is usually carried out only once. The support ring can then remain in position on the lens.

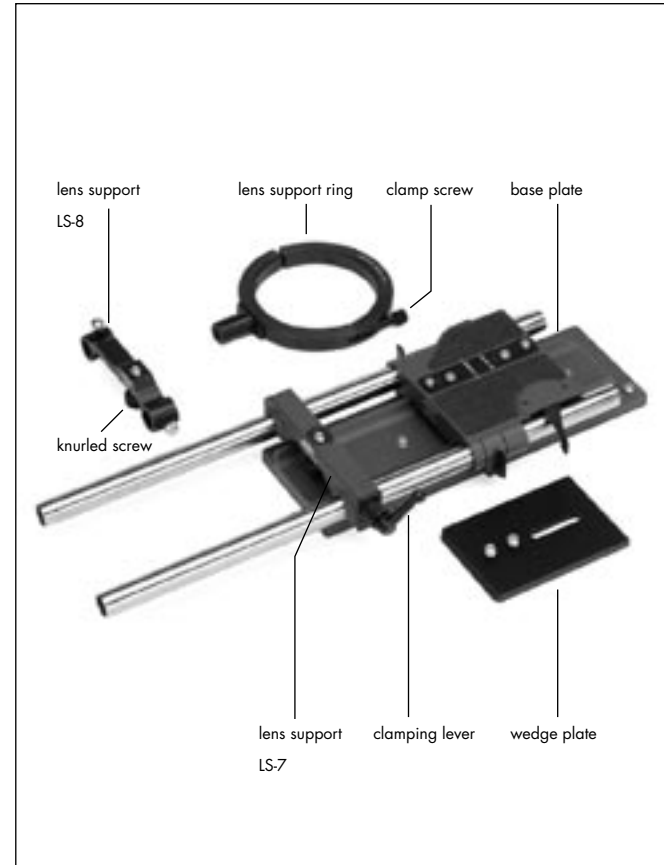

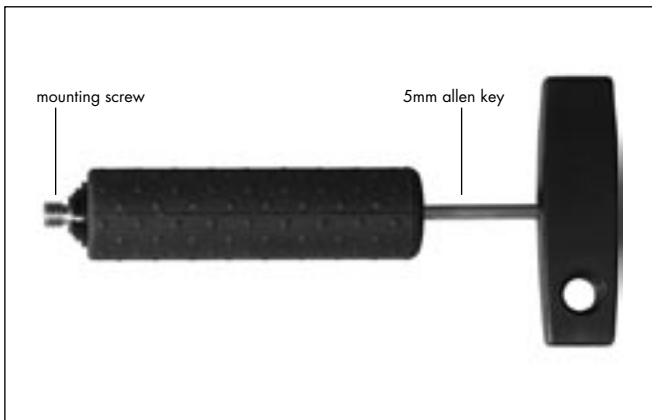
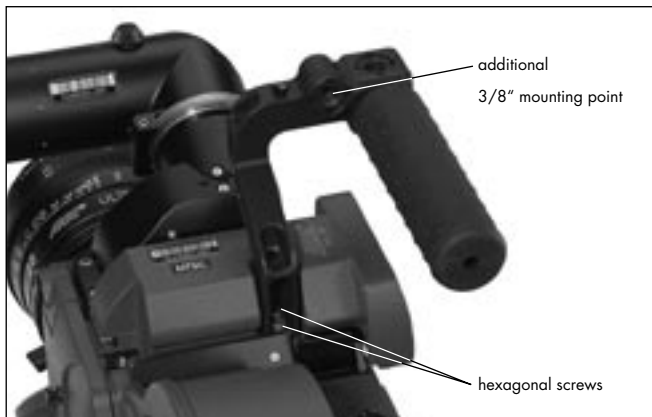

## 4.6 Grip System

The multipurpose grip system on the ARRIFLEX 235 guarantees high stability through its fixed connection to the camera body and provides numerous possibilities for attaching accessories. 3/8" inner threads allow attachment in various positions. The versatile system adapts to all needs depending on the magazine used with the camera.

### Standard Camera Handle

The standard camera handle is a single post handle. It can be mounted in two positions to the camera using two hexagonal screws ⇨ **photo**. In one position, the handle grip is positioned above the camera, in the center of gravity. This is useful for low handheld shots, but only works with the two 235 Shoulder Magazines. In the other position, as seen on the photo, all magazines can be accommodated.

The handgrip can be attached to any of the 3/8" holes by first placing the 2 pins ⇨ **photo** into the according pin holes on the post and then fastening the handgrip screw ⇨ **photo** inside the handgrip by using a long 5mm allen key.

**Note:** If the standard camera handle is attached in the other position and the handgrip is mounted to the additional 3/8" hole the handgrip is positioned in the center of gravity.

## Low Mode Handle

The low mode handle is a triple post handle. It can be mounted to the camera using 3 hexagonal screws ⇨ **photo**.

To the low mode handle various accessories can be attached using the 3/8" holes.

The low mode handle can be extended with the handle extension block ⇨ **photo**. The handle extension block can be mounted to any of the 3/8" holes by first placing the 2 pins ⇨ **photo** into the according pin holes on the handle and then fastening the extension block screw ⇨ **photo** inside the extension block by using a long 5mm allen key. Note that the viewfinder cannot be swung over to the camera right side when the Handle Extension Block is attached to the front of the Low Mode Handle.

**Note:** The low mode handle is positioned in the center of gravity.

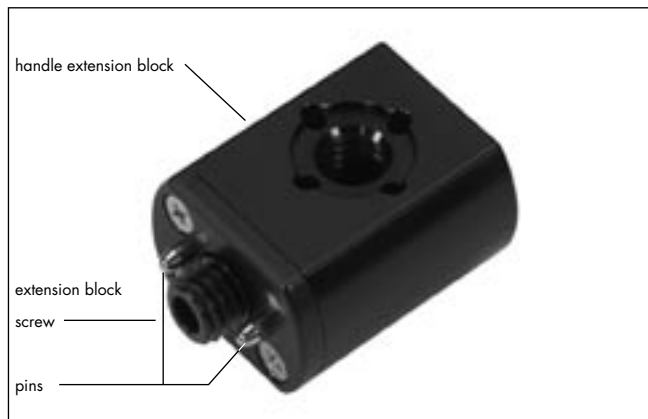
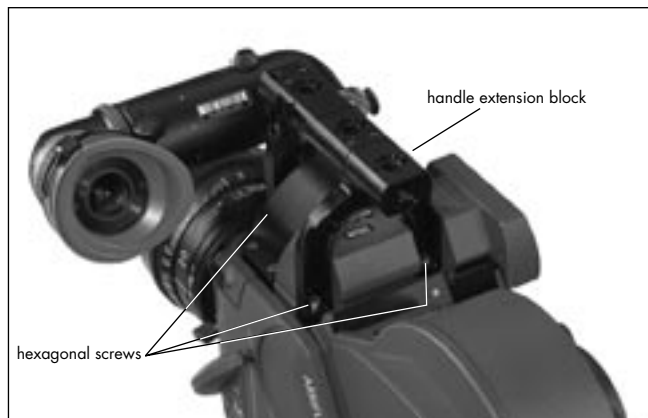

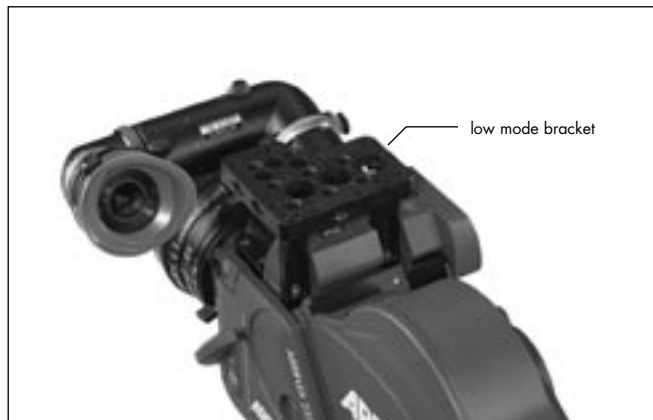
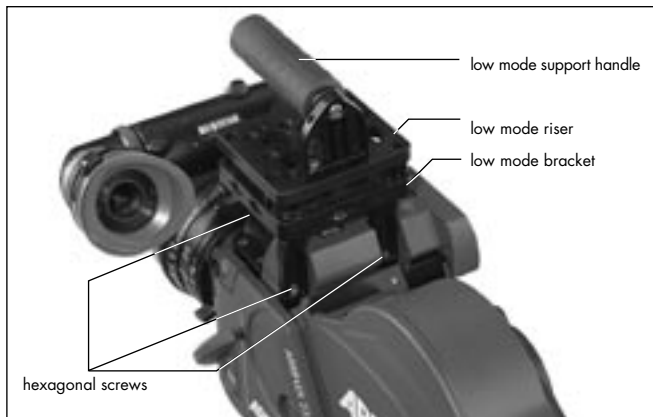

## Low Mode Support LMS-1

The Low Mode Support LMS-1 ⇨ **photo** is a sturdy triple post camera handle with integrated Steadicam low mode plate that attaches to the 235 camera body. It consists of the Low Mode Bracket (K4.65142.0) ⇨ **photo**, the Low Mode Support Handle (K4.65140.0) ⇨ **photo** and Low Mode Riser (K4.65141.0) ⇨ **photo** and is compatible with all magazines. The Low Mode Bracket is mounted with 3 hexagonal screws ⇨ **photo** to the 235 camera body.

The Low-Mode Handle can be attached on both the basic Low-Mode Bracket or the Low-Mode Riser. There are two mounting positions on the plates, one at the rear of the plate ⇨ **photo**, and one position 65mm forwards. The handle can be mounted in either position facing forwards or rearwards; in this way, the grip balance can be adapted to best fit the magazine and lens in use.

The Low-Mode Bracket alone offers the lowest profile and smallest plate-to-lens distance, optimal for Steadicam applications. It can be attached with the viewfinder on the camera; however, since the Low-Mode Bracket remains under the level of the viewfinder itself, removal of the viewfinder will be necessary in applications requiring the attachment of a longer plate onto the Low-Mode Bracket.

With the Low-Mode Riser, plate-to-lens distance is increased, but the plate level is now above the level of the viewfinder; a longer plate attached to the Riser will not collide with the viewfinder. This is especially useful in situations where rapid switching between operation in low-mode and operation with viewfinder is necessary.

A measuring tape hook is located camera right on the Low-Mode Bracket, and both the Low-Mode Bracket and Low-Mode Riser offer diverse attachment points for additional accessories.

## Side Bracket SBR-1

The 235 Side Bracket SBR-1 (K2.55015.0) ⇨ **photo** offers two adjustable 19mm support rods positioned camera right for attachment of lens motors, Lightweight Follow Focus LFF-1 (K0.60021.0) and other accessories with rod mounts. It attaches to the 235 via the right-side 3/8" accessory mounting point and the rosette mount. For a further setup with the handgrip, the SBR-1 retains its own rosette mount

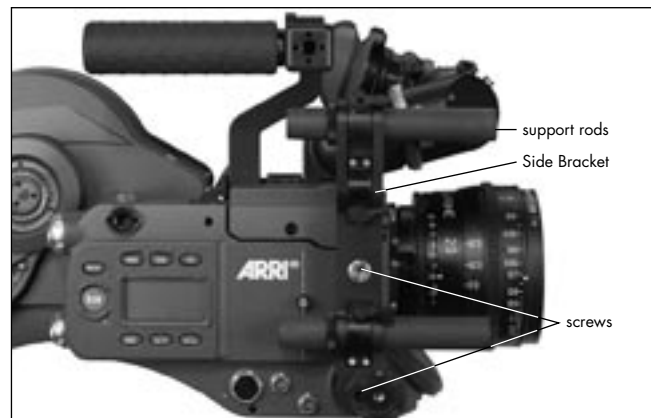

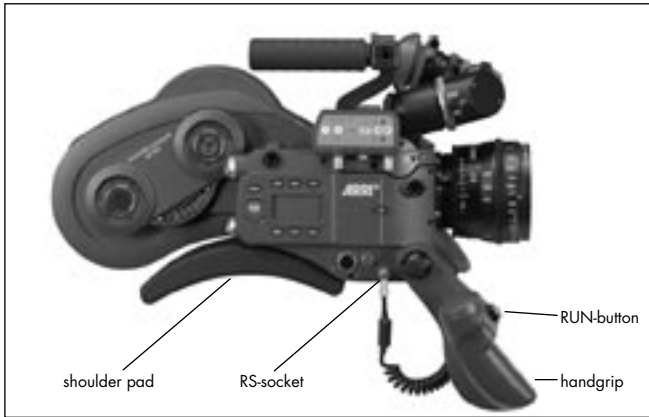

## 4.7 Operation from the Shoulder

The shoulder cushion can be used with or without the riser plate.

- Attach the shoulder pad to the camera body by aligning the velcro® tapes ⇨ **photo**.
- Position the handgrip on the rosette and fasten with the fastening screw ⇨ **photo**.
- Plug the cable for starting and stopping the camera into the RS-socket.



## 5. Power Supply

The acceptable voltage range is from 20.6 to 35 V DC. The power supply cable is attached to the power supply socket on the camera. Available are:

- the battery NC 24/7 R with charger NCL 24 R
- the mains unit NG 12/24 R.
- the mains unit NG 12/26 R ⇨ **photo**.
- the on-board battery OBB-1 with charger ⇨ **photo**.

- First switch on the mains unit (if used).
- Connect the camera to the mains unit or to the battery.
- Switch on the main switch of the camera.



*Do not open the batteries!  
Charge batteries only with the proper ARRI chargers!*



*Do not bypass the fuse or temperature switch!*



*Do not heat NC-batteries!  
Do not short-circuit NC-batteries!*

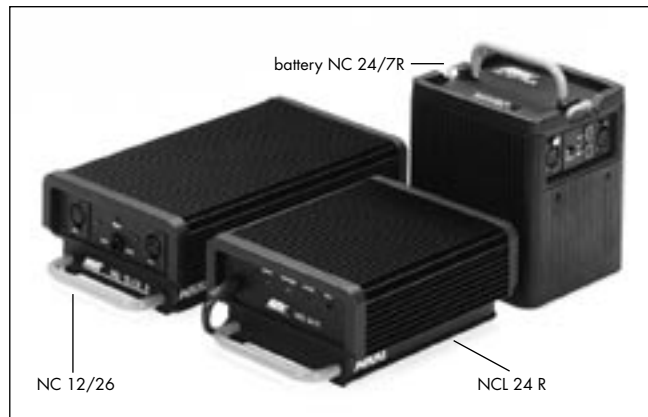

## 5.1 Battery NC 24/7 R

The battery NC 24/7 R has a capacity of 7 ampere-hours.

- Ensure that the main switch on the camera is off.
- Plug the battery cable KC 20S or the spiral battery cable KC 29S into the power supply socket on the camera and into the battery-socket.

Note: If the battery voltage is not sufficient, the “bat” symbol will show in the camera display.

## 5.2 Charger NCL 24 R

With this charger the battery NC 24/7 R can be charged.

- First check whether the correct mains voltage is set on the charger.
- Connect the charger to the mains supply.
- Plug the charger cable into the battery socket.
- Press the start button.

### Indication of the LEDs

LED	Indication
yellow	discharging (1A)
red	charging
green	charger connected to the mains

### 5.3 Mains Unit NG 12/24 R

Use of the mains unit is recommended for filming in the studio and when using electronic accessories with a high power consumption.

- First check that the correct mains voltage is set on the mains unit.
- Ensure that the main switch on the camera is off.
- Set the voltage switch on the mains unit to 24 V.
- Plug the battery cable KC 20S or the spiral battery cable KC 29S into the power supply socket on the camera and into the 24 V-socket on the mains unit.

### 5.4 Mains Unit NG 12/26 R

Use of the mains unit is recommended for filming in the studio and when using electronic accessories with a high power consumption.

- First check that the correct mains voltage is set on the mains unit.
- Ensure that the main switch on the camera is off.
- Set the voltage switch on the mains unit to 26 V.
- Plug the battery cable KC 20S or the spiral battery cable KC 29S into the power supply socket on the camera and into the 26 V-socket on the mains unit.

Note: The NG 12/24 R can easily be upgraded to an NG 12/26 R at an ARRI service center.



## 5.5 Accessory Power Supply

### 24 V Accessories



*The RS-sockets supply the same voltage as the camera power supply.  
Ensure that the accessories to be used are suited to the available voltage!*

24 V accessories are normally attached to the RS-sockets  
⇨ **photo**. At 24 V, the available continuous current for both sockets together is 3 A maximum, the peak load 5 A.

### Overload Display

If the current drawn at the accessory sockets exceeds the allowable maximum, a self resetting safety circuit interrupts the power supply. In that case, turn the camera off, unplug all accessories from the camera, wait for one minute and turn the camera back on.

## 6. Magazines

In addition to the new 235 magazines, all ARRIFLEX 435, ARRIFLEX 35 III and 35 II magazines – with the exception of the shoulder magazine and all 300m/1000ft magazines – can be used.



*Reverse operation with the ARRIFLEX 35 III/35 II 60m and the 235 shoulder magazines can lead to damage of the magazine or the camera!*



*Do not use any 300m/1000ft magazines as they could damage the camera.*



*Do not use magazines that hold more than 120m/400ft loads. The camera automatically stops after a full load.*

**Note:** All magazines listed on the right are loaded with the same loop length as on the ARRIFLEX 435 and the ARRIFLEX 35 III. The loading of ARRIFLEX 35 III and the ARRIFLEX 435 magazines is described in the respective instruction manuals.

Magazine	Forward/Reverse operation
<b>ARRIFLEX 235</b>	
Shoulder Magazine 60/200 SHM-1 .....	only forwards
Shoulder Magazine 120/400 SHM-2 .....	only forwards
Steadicam Magazine 120/400 STM-1 .....	forw./rev.
<b>ARRIFLEX 435</b>	
ARRIMAG 120 .....	forw./rev.
ARRIMAG 120S .....	forw./rev.
<b>ARRIFLEX 35 III / 35 II</b>	
60 m magazine .....	only forwards
150 m magazine .....	forw./rev.

## 6.1 Loading the Shoulder Magazine

Loading the magazine should be practised in daylight with a piece of test film until the procedure can also be carried out confidently in a darkroom or film changing bag.

Cutting the film through the middle of the perforation holes simplifies the loading process considerably. The ARRI Film Cutting Gauge ⇨ **photo** simplifies cutting in the darkroom.

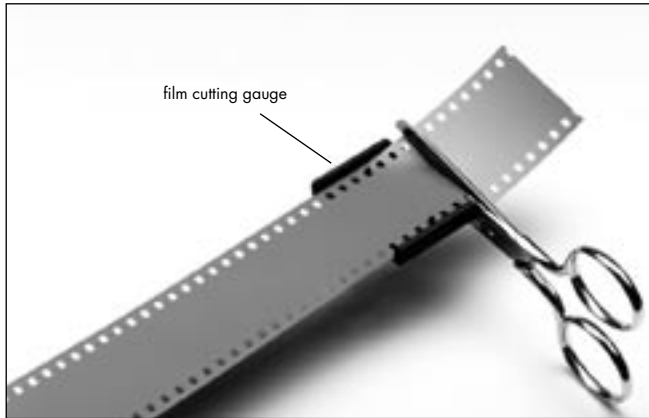

The following steps should be carried out in a darkroom or film changing bag!

- Remove the loop protector and lay the magazine on a flat surface with its cover facing upwards.
- To open the cover, depress the safety catch, flip up the locking grip and turn it counter-clockwise ⇨ **photo**.
- Lift up the magazine cover and remove it by pulling the cover to the left.

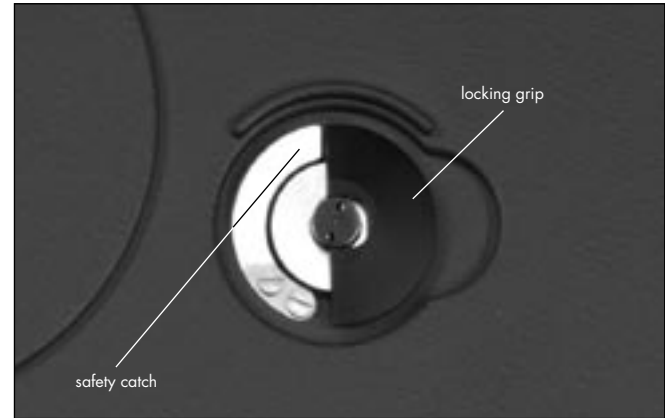

- Swing the roller arm ⇨ **photo** away from the winding shaft until it locks in place.
- Place the film roll next to the magazine, preferably on a film can.
- Insert the film through the upper slit on the magazine throat assembly from the inside ⇨ **photo**.  
Do not catch the film.
- With your free hand, turn the drive gear counter-clockwise while carefully pushing the film through until both perforation holes are picked up simultaneously by the sprockets.
- Keep turning the gear until the film has been transported through the throat assembly.

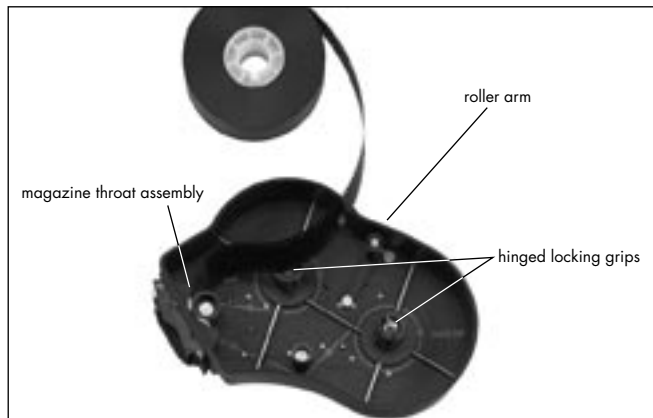

- Flip up the hinged locking clip on the feed shaft ⇨ **photo**.
- Place the film roll on the feed shaft, ensuring that the feed shaft catch engages the slot on the plastic core.
- Press down the hinged locking clip on the feed shaft.
- By turning the drive gear counter-clockwise, transport the film further until it reaches to the loop length marking ⇨ **photo**.



*Ensure that the film is lying flat against the outside of the magazine housing.*

- Without changing the length, thread the film into the right film channel. Do not catch the film.

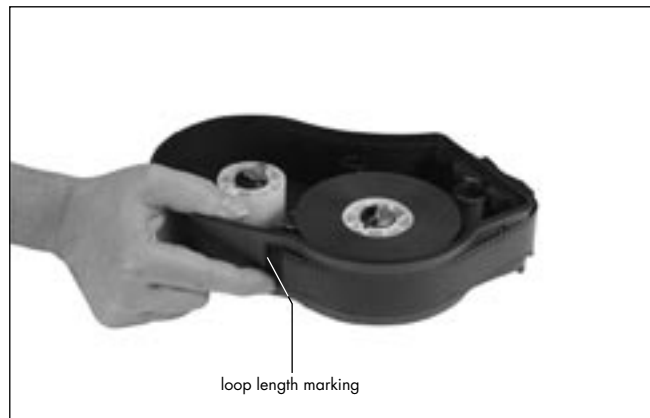

- By again turning the drive gear counter-clockwise, transport the film inside the magazine.
  - Flip up the hinged locking clip on the take-up shaft ⇨ **photo**.
  - Place an empty film core on the take-up shaft. Ensure that the take-up shaft catch engages the slot on the plastic core.
  - Press down the hinged locking clip on the take-up shaft.
  - Insert the film into the slit of the film core ⇨ **photo**.
  - Wind the film on several revolutions until it is certain that the film is firmly seated on the film core.
- Check that the film is being taken up perpendicular to the shaft ⇨ **photo**.
  - Close the magazine cover by inserting the two latches into the slits of the magazine housing and then closing the cover. The roller arm will be automatically unlocked.
  - To lock the cover, turn the locking grip clockwise and flip it back into the recess. The safety catch locks automatically.

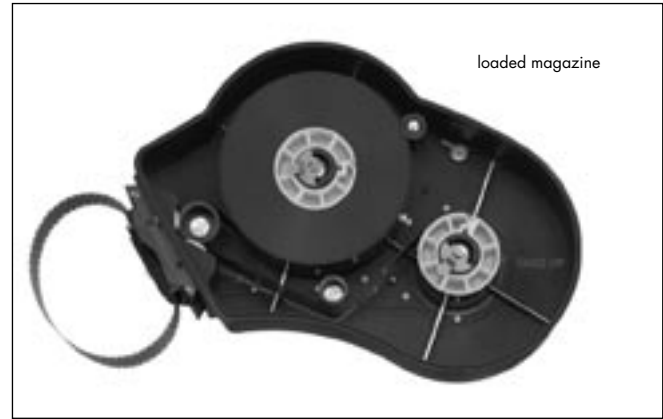
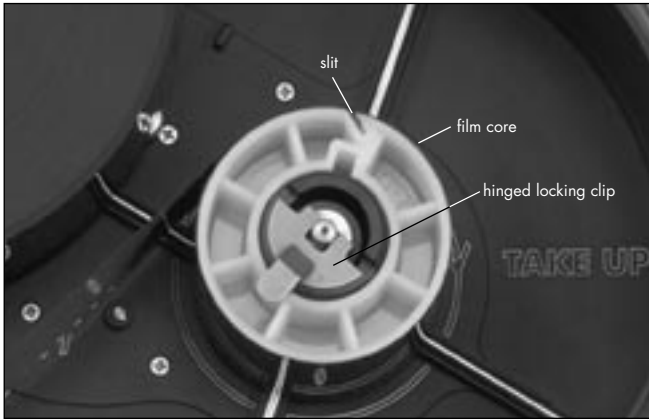



Note: To tension the film in the magazine, press in both tensioning plates ⇨ **photo** and turn outwards.

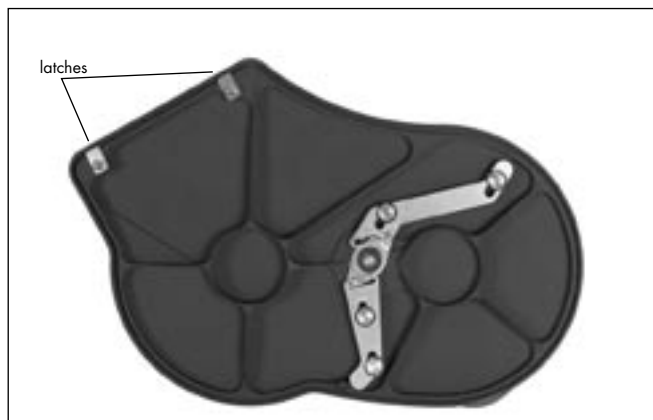
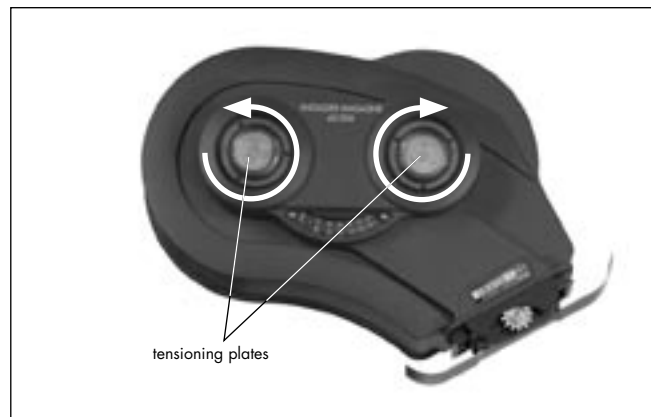

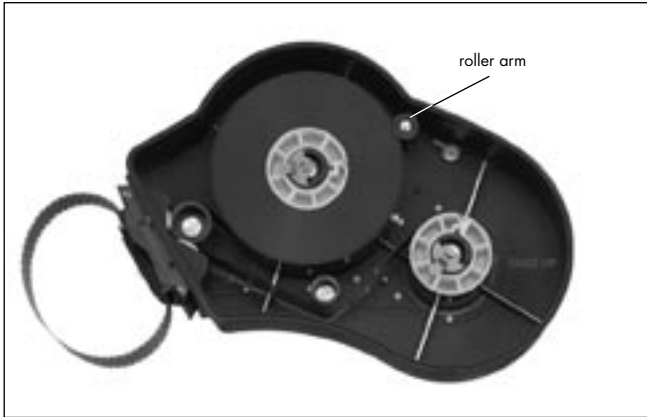

## 6.2 Removing Exposed Film

The following steps should be carried out in a darkroom or a changing bag!

- Check if the entire film has been wound into the interior of the magazine. If not, transport the film into the magazine by turning the drive gear counter-clockwise.
- To open the cover, depress the safety catch and flip the locking grip upwards. Then turn the grip counter-clock-wise.
- Lift up the cover and remove it by pulling it to the left.
- Swing the roller arm ⇨ **photo** away from the winding shaft until it locks in place.
- Flip up the hinged locking clip on the take-up shaft.
- Pull the film roll upwards and off.

Note: When pulling the film roll off the shaft, grip it from underneath as far as possible to prevent the middle of the film roll from sagging down.



*The film should under no circumstances be pulled tight. This could cause scratches and static charging.*

## 6.3 Transport and Storage

Loaded or empty magazines should only be transported or stored with the loop protector ⇨ **photo** attached to avoid damage to the film stock and the magazine throat assembly.

If the ARRIFLEX 235 is transported without a magazine it is recommended to attach the magazine opening cover ⇨ **photo**.





## 7. Camera Body

### 7.1 Mechanically Adjustable Mirror Shutter

The mirror shutter on the ARRIFLEX 235 can be mechanically adjusted while the camera is switched off. The shutter angle can be adjusted from 45° to 180°. The shutter locks in the following positions: 45°, 60°, 75°, 90°, 105°, 120°, 135°, 144°, 172,5°, and 180°.

#### Setting the Mirror Shutter Angle

- Switch off the camera and disconnect the camera from the power supply!
- Remove the lens or the protective cap from the lens mount receptacle.



*Do not touch the surface of the mirror.*

- Turn the movement inching knob ⇔ **photo** until the hole on the shutter and the hole in the camera body align ⇔ **photo**.



inching knob

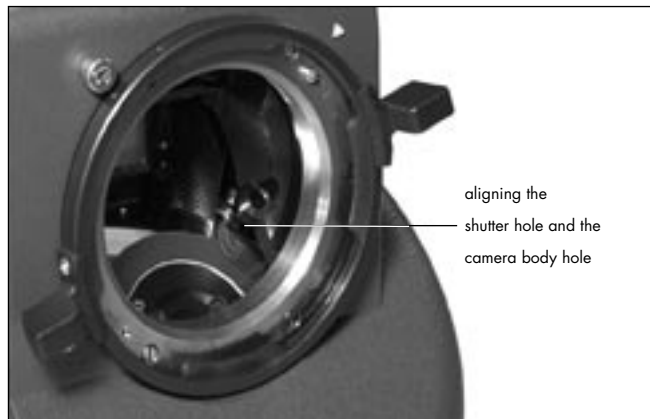

aligning the shutter hole and the camera body hole

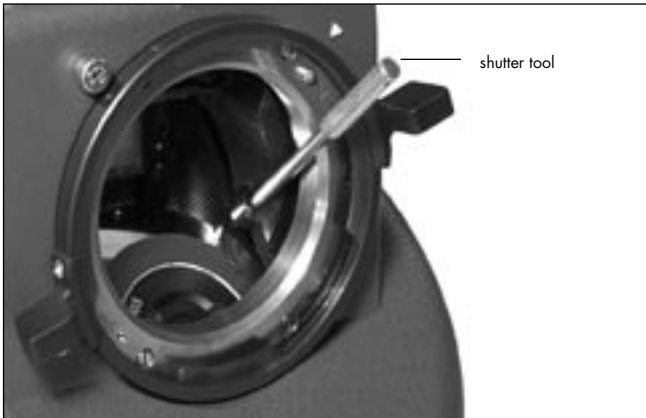

- Insert the shutter tool ⇨ **photo** fully into the holes to unlock the shutter blade and to hold the shutter in its position.
- Turn the movement inching knob to set the shutter to the desired shutter opening. Make sure the shutter registers properly at the set opening.
- Pull out the shutter tool.



*Operation of the camera when the mirror shutter is not correctly locked in position may cause incorrect exposure!*



### Shutter Angle Measurement

- Holding the "PHASE"-button depressed in standby will make the camera inch forward.
- The display shows the measured shutter angle in the upper line. The lower line displays the voltage of the power supply.

## Filming with HMI Light

When lighting scenes with HMI/CID-discharge lamps, the pulsing light intensity is dependent on the supply frequency. To achieve constant exposure, the camera's frame rate, the supply frequency of the lighting and the angle of the mirror shutter must all relate to each other. As the camera frame rate and the supply frequency of the lighting are normally given, compensation must be carried out through the angle of the mirror shutter.

The following table indicates the mirror shutter angle that needs to be set:

Supply frequency	50 Hz		60 Hz
Frame rate	25 fps	24 fps	24 fps
Shutter angle	180°	172.8°	144°

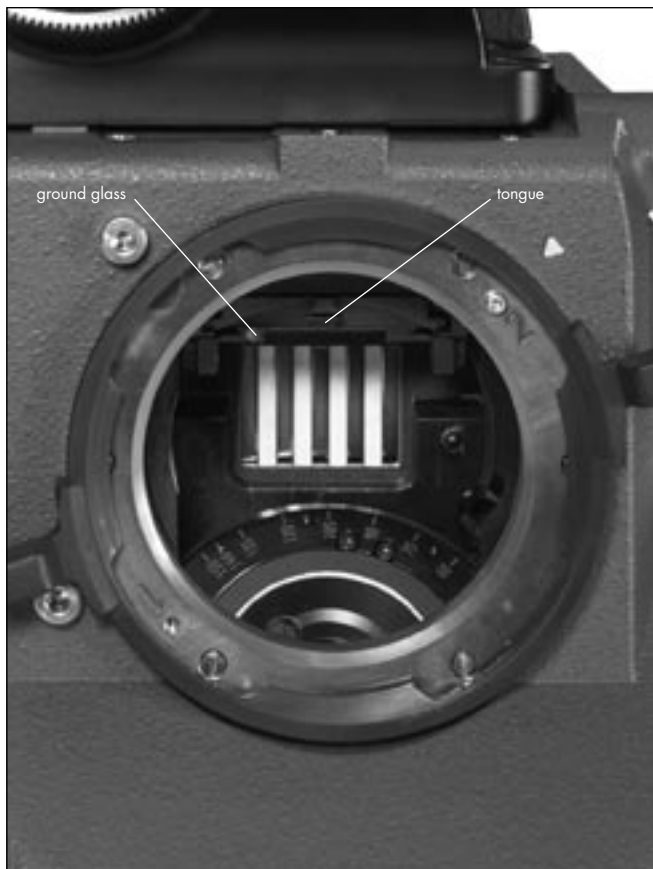

## 7.2 Exchanging the Ground Glass

- By briefly depressing the "PHASE"-button in standby, the shutter is positioned to protect the mirror surface from damage as far as possible ⇨ **photo**.
- Before exchanging the ground glass, switch the camera's main switch off and disconnect the camera from the power supply!
- Remove the lens or the protective cap.



*Do not touch the mirror surface!*

- Using the included special forceps, pull the ground glass ⇨ **photo** out of the holder by its tongue ⇨ **photo**.
- Check that the ground glass to be inserted as well as the ground glass frame are completely clean.
- With the special forceps, push the chosen ground glass into the holder as far as it will go. The red marker point must be on the left. A ball catch fixes the ground glass exactly in the right position.
- Check that the ground glass is correctly locked in place.

Note:      Cleaning or exchanging the field lens, see Chapter 13 Maintenance, Cleaning the Field Lens.



## 7.3 Movement

The ARRIFLEX 235 features a 5-link movement, equipped with ball-bearings for low maintenance.



*Never operate the movement locking mechanism while the camera is running!*

### Removing the Spacer Plate

- Open the movement by turning the inching knob ⇨ **photo** until the mark aligns with the mark on the movement and then turn the movement locking lever ⇨ **photo** towards the "OPEN" position.
- Press the spacer plate backwards by its handle ⇨ **photo**. Then remove it by pulling upwards.

### Installing the Spacer Plate

- Open the movement by turning the inching knob ⇨ **photo** until the mark aligns with the mark on the movement and then turn the movement locking lever ⇨ **photo** towards the "OPEN" position.
- Take hold of the spacer plate by its handle ⇨ **photo** and insert it at an angle from above into the movement block.
- Push the spacer plate downwards until it locks audibly in place.

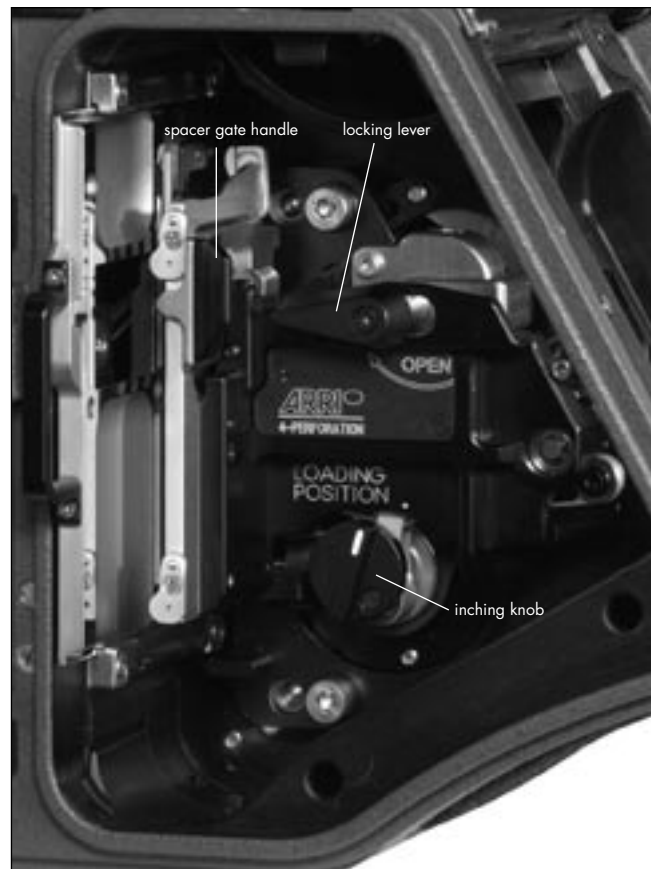

## 7.4 Attaching the Magazine, Threading the Film

- Pull the magazine release lever ⇨ **photo** back and remove the cover.
- Open the camera door.
- Remove the loop protector from the magazine.



*When attaching the magazine, pay attention that the film does not get caught between the magazine and the dovetail on the camera opening!*

- Position the back part of the magazine's throat assembly on the lower dovetail of the camera opening.
- With your left hand pull the film loop through the camera opening as far as possible into the movement block area ⇨ **photo**.
- Before locking the magazine into place, ensure that the film is pulled far enough into the movement block area so that the film does not get caught between the magazine and the magazine locking mechanism!
- Lock the magazine completely into the camera opening.

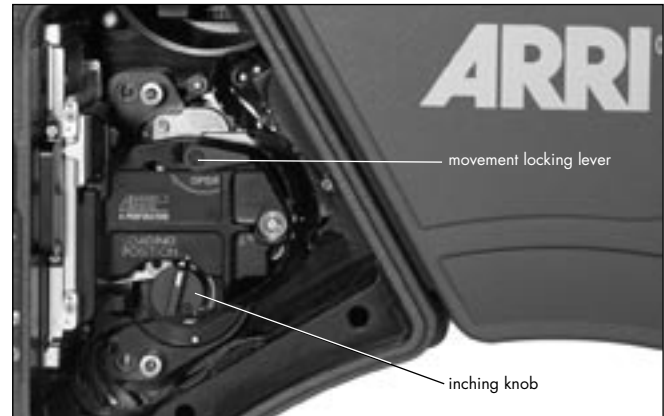

Note: The magazine drive gear engages automatically. In case it does not engage properly, turn the magazine drive gear slightly and try again.

- Check that the magazine is firmly seated.
- Open the movement by turning the inching knob ⇨ **photo** until the mark aligns with the mark on the movement and then turn the movement locking lever ⇨ **photo** towards the "OPEN" position.

- With your right hand pull the film loop downwards out of the camera ⇨ **photo**. Then push it as far upwards as possible so that the film collapses on the upper film loop. Insert the loop between the movement plate and the film gate.
- Bring the film loop into position ⇨ **photo**.
- Position the film by one perforation hole onto the positioning pin ⇨ **photo** in the film guide, bringing the film loop to rest within the marking ⇨ **photo**.
- Check that the film is correctly fixed on the positioning pin. Check that the loop is positioned within the upper marking, and that the film aligns with the film gate.



Note: Before the movement block is swung forwards, make sure that the film is correctly positioned in relation to the film gate over the entire area, otherwise the film may be damaged!

- Turn the movement locking lever counter-clockwise as far as it will go. This will cause the movement block to swing forwards and to lock into position.
- By turning the inching knob ⇄ **photo**, check that the film runs smoothly.
- Close the camera door.

Note: Threading the film is also described and displayed on the inside of the camera door.

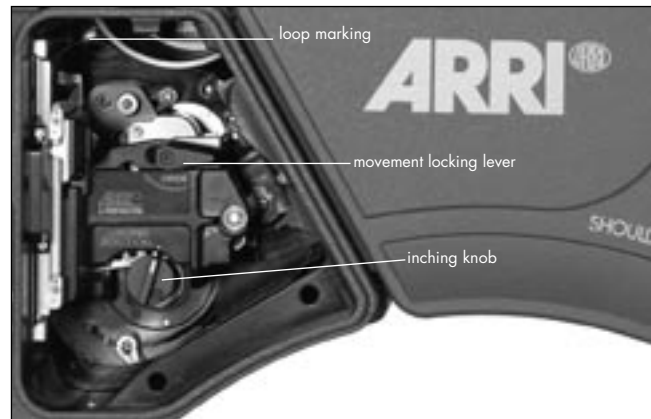

## 7.5 Removing the Magazine

If the film has not run through the camera completely:

- Open the camera door.
- Open the movement by turning the inching knob
  - ⇒ **photo** until the mark aligns with the mark on the movement and then turn the movement locking lever
  - ⇒ **photo** towards the „OPEN“ position.
- Pull out the film loop sideways from between the movement block and the film gate.
- Bring the loop into the area between the movement block and the magazine throat assembly.



*Ensure that the loop does not get twisted behind the movement block as otherwise the film could be damaged when removing the magazine!*

- Swing the movement block forwards again and lock.
- Hold the magazine firmly with one hand and pull the magazine locking lever back with the other.



*When pulling away the magazine ensure that the film does not get damaged!*

- Pull the magazine off upwards.
- Replace the cover on the camera opening.

If the entire film has run through the camera:

- Hold the magazine firmly with one hand and pull the magazine release lever back with the other.
- Pull the magazine off upwards.
- Replace the cover on the camera opening.



## 8. Optics

### 8.1 Lenses

All ARRIFLEX lenses with a PL-mount can be used. Lenses with a  $\varnothing$  41 mm standard or bayonet mount cannot be used. Heavy and long lenses, such as zoom-lenses, must be supported at all times.

#### Attaching Lenses

- Remove the protective cap from the lens mount receptacle by turning the bayonet ring ⇨ **photo** counter-clockwise as far as it will go and then pulling out the protective cap.



*Never put your fingers into the lens mount receptacle.*

- Push the lens into the lens mount receptacle without catching it at the edges. One of the four slots on the lens mount must fit over the index pin ⇨ **photo**.
- Press the lens flat onto the lens mount receptacle and pull the bayonet ring clockwise to tighten.

Note: The camera is delivered in Super 35 configuration. To shot Normal 35 the lens mount receptacle must be turned 180°. See Chapter 12, Super 35.

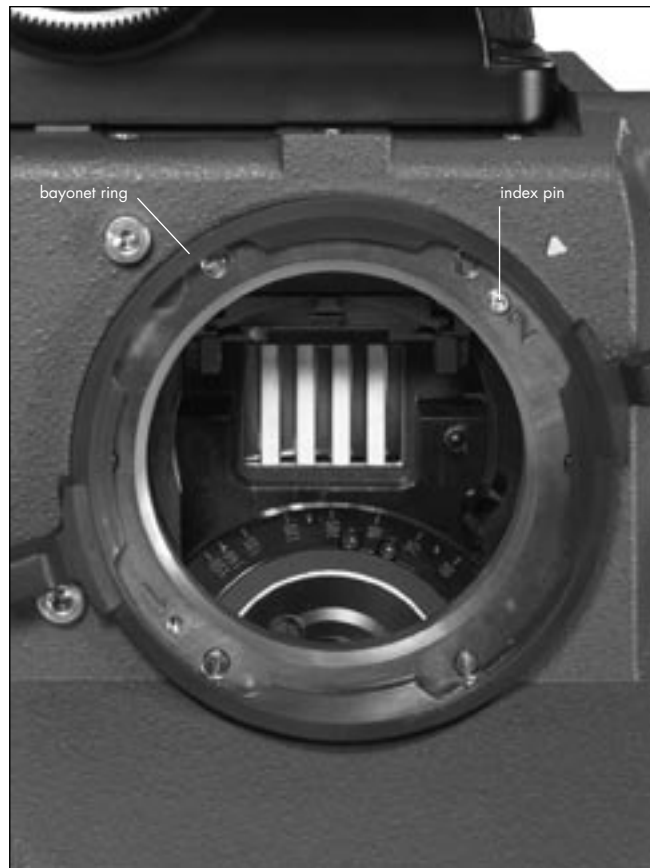



## 8.2 Viewfinder System

The viewfinder system on the ARRIFLEX 235 can be swivelled in two axes. The viewfinder image is always upright and correct left-to-right when the viewfinder is swivelled within the main axes ⇨ **photo**.

An 80/20 beamsplitter for the video assist is integrated into the camera body. The viewfinder and the video assist can be used independently from each other.

### The Eyepiece

#### Removing the Eyepiece

- Hold the eyepiece with one hand and with the other turn the knurled ring (eyepiece) ⇨ **photo** towards the "OPEN" position as far as it will go.
- Remove the eyepiece ⇨ **photo**.

#### Attaching the Eyepiece

- Ensure that the knurled ring is turned to the "OPEN" position.
- Position the eyepiece on the viewfinder.
- Turn the knurled ring (eyepiece) ⇨ **photo** towards the "LOCK" position.
- Check that the eyepiece is correctly seated.

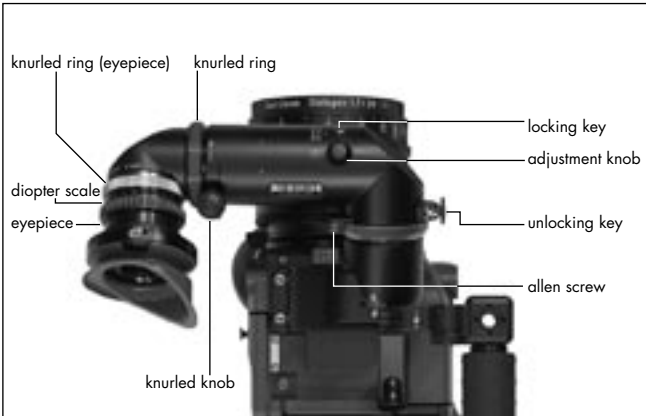



### Adjusting the Diopter

The diopter compensation is fitted with a scale ⇨ **photo** of 1 to 12. Position "6" is normal focus.

- To adjust, turn the ring right/left until the ground glass markings are totally in focus.

### Adjusting the Viewfinder

#### Turning the Eyepiece

The eyepiece can be rotated 360° around the viewfinder arm. The eyepiece is held in position by friction.

- To set friction, turn the knurled knob ⇨ **photo** right/left until the desired friction has been reached.

#### Swivelling the Viewfinder Arm

The viewfinder arm can be swivelled approx. 270° left to right. On the left side of the camera the viewfinder arm locks into the horizontal position. The viewfinder arm friction can be altered if necessary by turning the allen screw ⇨ **photo**.

- To adjust the viewfinder arm, release the locking mechanism by pulling the unlocking key ⇨ **photo**.
- Turn the viewfinder arm to the desired position.



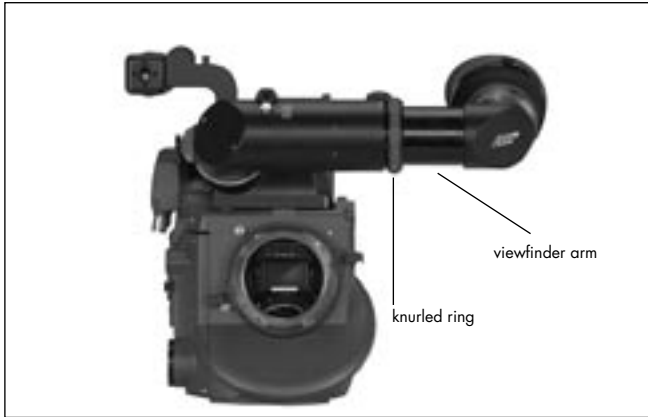

Note: The unlocking key can be locked in its open position by turning it.

### Extending the Viewfinder Arm

The viewfinder arm can be telescoped continuously by approx. 40 mm.

- Turn the knurled ring ⇨ **photo** towards the "LOOSE" position.
- Pull the viewfinder arm ⇨ **photo** out to the desired length.
- Retighten the knurled ring.

### Image Compensation

The viewfinder system is fitted with an automatic image compensation mechanism.

To enable setting a different image position in certain situations, the viewfinder system is additionally equipped with a manual image adjustment mechanism.

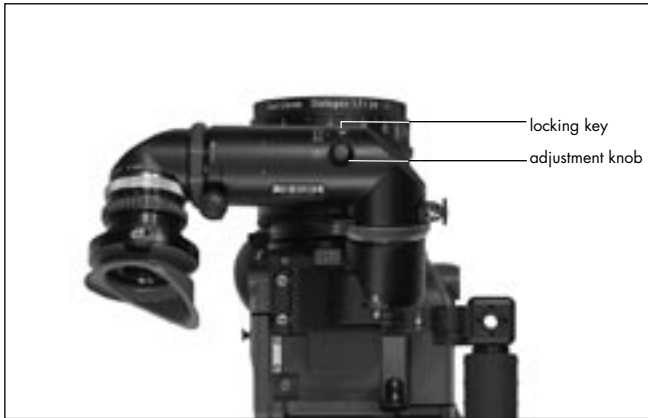

### Manually Adjusting Image Compensation

- Depress the locking key ⇨ **photo** and hold depressed.
- Turn the adjustment knob ⇨ **photo** until the viewfinder image is in the desired position.

### Reactivating Image Compensation

- Turn the adjustment knob ⇨ **photo** until it locks in position. Do not depress the locking key.

Note: The automatic image compensation locks in two positions, 180° apart. This allows the image compensation to be set to provide an upright image when using a finder extension.

If the viewfinder image is inverted without the finder extension, the image compensation must be adjusted to the opposite locking position.

### Inverting the Image

- Depress the locking key ⇨ **photo** and keep depressed.
- Turn the adjustment knob ⇨ **photo**.
- Release the locking key ⇨ **photo**.
- Keep turning the adjustment knob ⇨ **photo** until this locks in position.



### Removing the Viewfinder System

Before removing the viewfinder system, the viewfinder arm should be brought back to its normal position.

- Loosen the three fastening screws ⇨ **photo**.
- Pull the viewfinder system up and off.

### Attaching the Viewfinder System

- Position the viewfinder system on the camera body from above.
- Tighten the fastening screws.



## 9. Camera Operation

### 9.1 Main Camera Switch

- First switch on the mains unit (if used).
- Connect the camera to the mains unit or to the battery.
- Push the “ON/OFF” button ⇨ **photo** to turn the camera on. Push the “ON/OFF” button for approx. 3 seconds to turn the camera off again.

Note: When the camera power cable is unplugged and then plugged in again, the camera will be on or off depending on its state before the camera cable was unplugged.

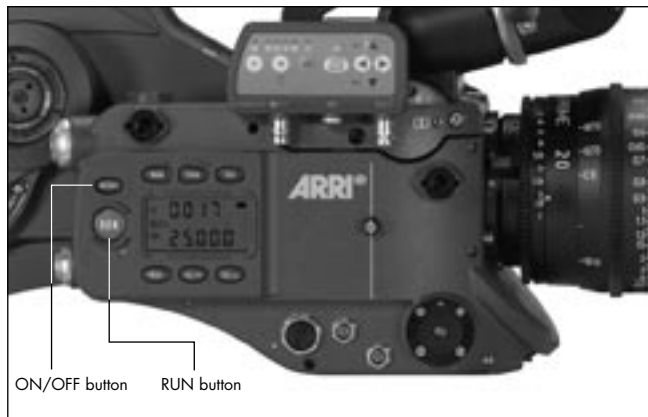

### 9.2 Running and Stopping the Camera

A “RUN”-button is located on the left and on the right side of the camera ⇨ **photo**.

#### Running the Camera



*If the operation control indicator glows red while in standby, the camera is not ready and will not run (see “Overview of Display Symbols”).*

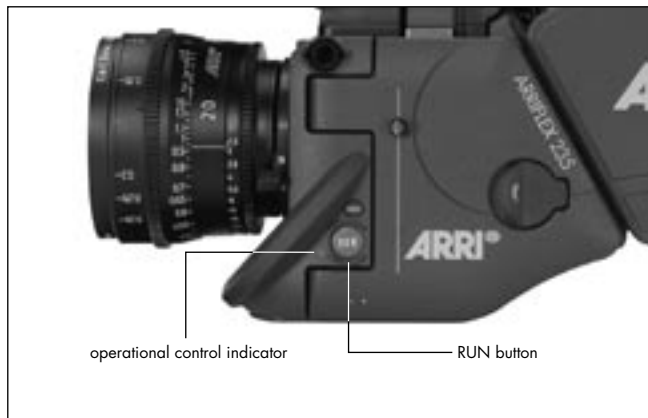

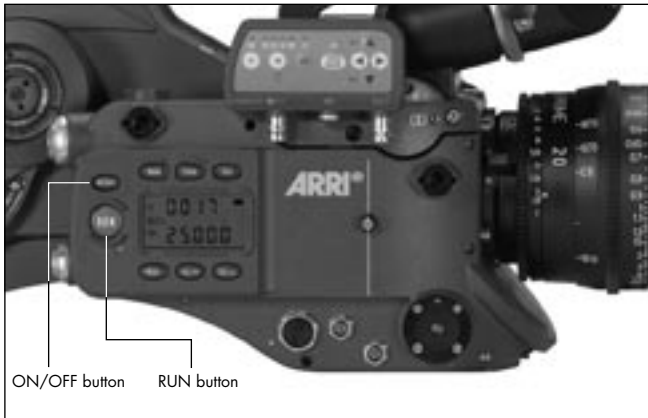

- Briefly depress the "RUN"-button. While the camera is running up, the operation control indicator ⇨ **photo** glows red. Once the set frame rate has been reached, the operation control indicator turns green.

### Stopping the Camera

- Again depress the "RUN"-button ⇨ **photo** briefly. While the camera is running down the operation control indicator glows red. The mirror shutter automatically stops in a position that enables unrestricted viewing through the viewfinder. On reaching this position, the operation control indicator flashes green before going out.

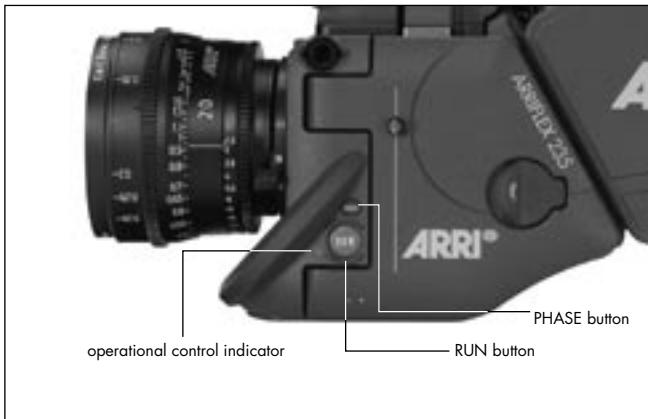

## Inching

Inching can be started by depressing the "PHASE"-button while the camera is in standby. If the "PHASE"-button is only briefly depressed, the mirror shutter rotates half a revolution to enable an unrestricted view of the film gate (e.g. for checking the gate). If the "PHASE"-button is held depressed longer, the camera will inch forward at approx. 1 fps. The upper line of the display indicates the measured shutter angle, the lower line the measured voltage of the power supply.



*While inching, the camera speed is not exactly controlled. As this can cause faulty exposures, do not film while inching.*

## 9.3 Displaying and Setting Operational Parameters

The currently set operational parameters on the ARRIFLEX 235 are displayed on the camera display ⇨ **photo** in various modes. The desired mode is selected via the "MODE"-button. In each mode the corresponding operational parameters can be set using the "SEL"- and "SET"-buttons ⇨ **photo**.

Note: The Mode numbers are shown in the display between the upper and the lower line. Mode 1 is also indicated ⇨ **photo** in the display by a black horizontal bar.

To prevent an unintentional alteration of the operational parameters the buttons "SEL", "SET", and "PHASE" can be locked using the button "LOCK". If a button is depressed when the display is locked, the display will show the "OFF" sign. If the display is locked, this is indicated by the "LOCK" symbol in the display.

Note: Locking the "PHASE"-button has no influence on the inching function.



*Locking the "SEL"- and "SET"-buttons has no influence on accessories such as the RCU-1.*

## Overview of Display Modes

Mode 1 is displayed:  
 after switching on the camera,  
 after depressing the "RUN"-button or  
 30 seconds after the last operation.

	1st Display Line	2nd Display Line	Adjustment Possibility
<b>Mode 1</b>	total exposed film counter (m/ft) or take counter (m/ft)	frame rate (fps) or ESU in standby and frame rate (fps) while running (external control connected)	selection of a standard frame rate configuration of the 1st display line
<b>Mode 2</b>	programmed frame rate (PS) ESU – external control connected	programmed frame rate (fps)	programmed frame rate (forwards / reverse)
<b>Mode 3</b>	total exposed film counter (m/ft) or take-counter (m/ft)	power supply voltage (V)	configuration of the film counter unit of measurement (m/ft)
<b>Mode 4</b>	volume of the acoustic warning signal	brightness of the keypad	warning signal on / off volume keypad intensity control
<b>Mode 5</b>	run up speed		selection of run up speed low/high



## Overview of Display Symbols

Symbol Meaning	
■	glows The display is in Mode 1.
bat	glows Battery voltage too low
asy	glows Asynchronous operation (camera is not running at set frame rate)
fps	glows display shows current frame rate blinks ESU is connected and no sync-frequency is available
8 7 6..	glows Mode number
NORM	glows camera will run the set NORM speed
PS/CCU	glows camera will run the set PS speed or the speed set by an accessory
LOCK	glows display is locked
m ft	glows indicates the unit in which the film consumption is counted
◁	glows display shows the current shutter angle
R	glows Reverse operation is switched on.

### Display: Movement Open

The display shows if the movement (= film transport, thus „trAnS“) has not been locked correctly into operating position.

The operation control indicator glows red  
the movement block is not correctly locked,  
the camera is not operational.

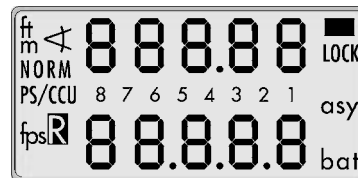



**Mode 1**

take length or total exposed film



**Mode 3**

total exposed film or takelength

## Film Counter

### Displaying the Film Counting Values (Modes 1 and 3)

Film counting values are shown in Modes 1 and 3. Two different counting values are shown respectively:

- the total amount of exposed film or
  - the take length (amount of film used in an individual take)
- A "1" in the first digit of the upper display line indicates the display of take length.

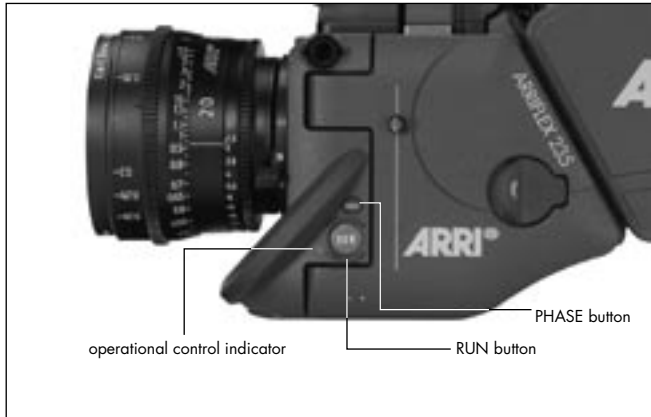

### Setting the Film Counter Configuration (Mode 3)

The display configuration can be set individually.  
The two shown combinations are possible:

The desired display configuration can be set in Mode 3:

- Change from Mode 1 to Mode 3 by depressing the "MODE"-button twice.
- Depress the "SEL"-button twice; the first digit in the upper display line blinks.
- Within three seconds, depress the "SET"-button.
- The currently set counting value of Mode 3 is displayed. The corresponding counting value in Mode 1 is automatically altered.

### Resetting the Film Counter (Modes 1 and 3)

- Change to the mode which shows the total amount of exposed film ("MODE"-button).
- The total exposed film counter can be set to zero by depressing the "SET"-button (for at least 1.5 seconds) while in standby.
- The take length counter is automatically reset each time the camera is started.

### Changing the Unit of Measurement (Meters/Feet) (Mode 3)

- Change from Mode 1 to Mode 3 by depressing the "MODE"-button twice.
- Depress the "SEL"-button once; the symbol m/ft blinks.
- Depress the "SET"-button within three seconds to change the unit of measurement.

### Displaying the Angle of the Mirror Shutter (Mode 1)

- As long as the "PHASE"-button is depressed while in standby, the set angle of the mirror shutter appears in the upper display line.  
The camera runs at inching speed.

Setting the shutter angle: see Chapter 7.



## Frame Rates

The ARRIFLEX 235 offers the possibility to set and store two frame rates. It is possible to select and store:

- a standard frame rate (23.976, 24, 25, 29.97 and 30 fps),
- and a freely programmed frame rate in increments of 0.001 fps.

The frame rate is activated via the "NORM PS/CCU"-buttons ⇄ **photo** on the right of the camera. The "NORM"-setting corresponds to the standard frame rate, the "PS/CCU"-position to the freely programmed frame rate.

## Selecting a Standard Frame Rate (Mode 1)

### Standby Operation

- The camera must be in Mode 1 and the camera must be set to "NORM".
- Depress the "SEL"-button repeatedly until the desired frame rate is selected. Within 3 seconds, confirm this choice by depressing the "SET"-button, otherwise the initial setting is retained.



## Setting a Programmed Frame Rate (Mode 2)

### Standby Operation

- Change from Mode 1 to Mode 2 by depressing the "MODE"-button once.
- Depress the "SEL"-button repeatedly until the digit to be set blinks.
- Depress the "SET"-button repeatedly until the desired value is reached.
- Repeat this procedure until all digits are set to the desired values. A final confirmation of the set frame rate is not necessary.

Note: The frame rate can be set between 1 and 60 fps forward and 25 fps reverse.

Note: The programmed frame rate is stored in a non-volatile memory.



## Switching Between Forward and Reverse Operation (Mode 2)

### Standby Operation

- Change from Mode 1 to Mode 2 by depressing the "MODE"-button once.
- Depress the "SEL"-button; "Cd" (Camera direction) blinks.
- Hold the "SET"-button depressed for more than three seconds. The display shows an "R" for reverse operation at the bottom left.

## Changing the Frame Rate while the Camera is Running

By means of the "NORM" and "PS/CCU"-buttons it is possible to switch between the standard frame rate ("NORM") and the pro-grammed frame rate ("PS/CCU") while the camera is running.



## Fine-Tuning the Programmed Frame Rate (PS-Mode)

Fine-tuning of the programmed frame rate can be carried out while the camera is running by means of the buttons "SEL" (slower) and "SET" (faster). The setting can be adjusted in increments of 0.001 fps.

- Push the "PS/CCU" button.
- Run the camera.
- Depress the "MODE"-button once to change to Mode 2.
- With the buttons "SEL" (slower) and "SET" (faster) change the frame rate.

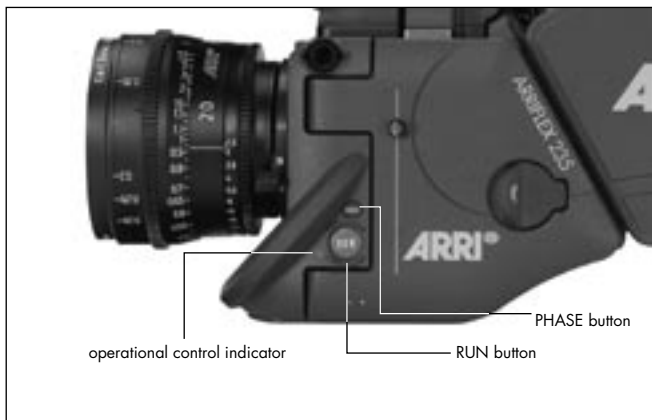

## Shifting Phase

To film quartz-synchronized monitors, hold the "PHASE"-button ⇨ **photo** depressed after the camera has run up until the horizontal bar is no longer visible in the viewfinder. The frame rate will increase by 0.2 fps while the button is depressed.

## Displaying the Power Supply Voltage (Mode 3)

- Change from Mode 1 to Mode 3 by depressing the "MODE"-button twice. The power supply voltage is shown in the lower line of the display.



## Setting the brightness of the button illumination

- Change from Mode 1 to Mode 4 by depressing the "MODE"-button three times.
- Depress the "SEL"-button three times to activate the display for setting the button illumination.
- Select the desired brightness using the "SET"-button.
  - 0...off
  - 3...maximum brightness



Display	Warning tone on start	Warning tone on stop
LS __	off	off
LS _	on	off
LS _-	off	on
LS --	on	on

## Switching On and Off the Warning Signal for Asynchronous Running (Mode 4)

### Standby Operation

- Change from Mode 1 to Mode 4 by depressing the "MODE"-button three times.
- By depressing the "SEL"-button once, activate the display for setting the warning signal.
- Within three seconds, depress the "SET"-button to select one of the four settings.
- Depressing the "MODE"-button confirms the selection.

### Setting the Volume of the Warning Signal

- Change from Mode 1 to Mode 4 by depressing the "MODE"-button three times.
- Depress the "SEL"-button two times to activate the display for setting the warning signal volume.
- Select the desired volume with the "SET"-button.  
0...off  
3...maximum volume



## Mode 5

### Changing the Run up Speed:

In menu 5 the run up speed can be changed in two steps. The faster run up speed uses less film, but sometimes when Steadicams or a very long power cable is used a longer run up time is easier on the batteries.

- Depress the "SEL"-key until the desired run up speed blinks.
- Select the desired run up speed by pressing the "SEL"-button.

### Displaying software versions

- Press "SET" for three seconds in the rampspeed menu: the first line will display Sxx.xx for the camera software version.  
The second line will display Fxx.xx for the FPGA software version
- Press "SEL": the first line will display bxx.xx for the bootloader software version.  
The second line will display Pxx.xx for the software version.

setting	ramping speed
LO	25f/s <sup>2</sup>
HI	40f/s <sup>2</sup>

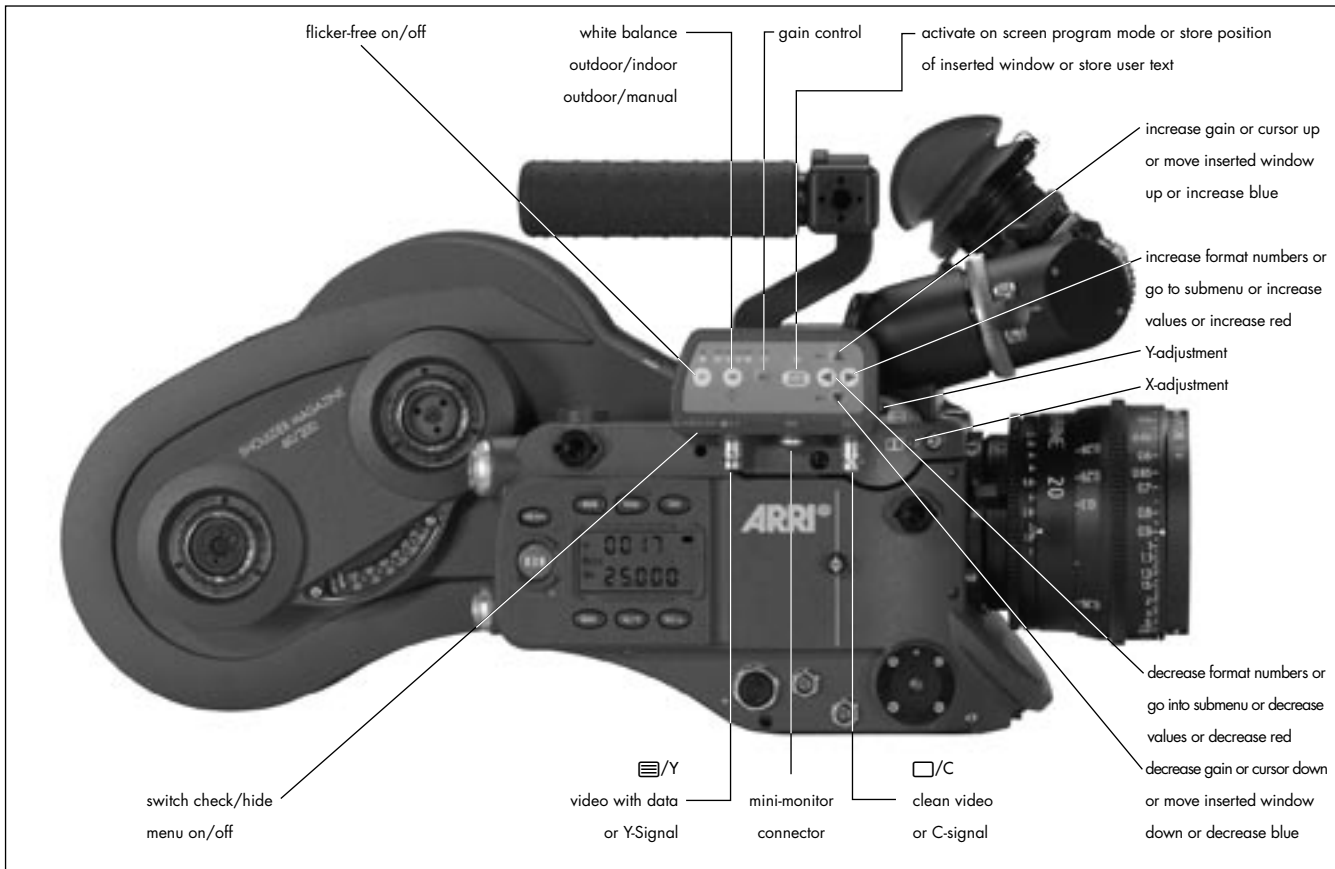

## 10. Video-Assist-System

### 10.1 General Description of the IVS

The Integrated Video-Assist System (IVS) for the ARRIFLEX 235 brings the highly praised video assist systems from the ARRIFLEX 435 and ARRICAM to the ARRIFLEX 235. It reassembles the IVS 435 control structure and of course offers the same unsurpassed image quality combined with a state-of-the-art inserter to add frame lines, camera status and text to the video image.

#### Main Features

- Integrated into the camera body  
Instead of a bulky add on, the video assist is an integrated part of the camera without additional cabling.
- High sensitivity  
A high-speed lens with an aperture of 1 : 2.0 and one of the most sensitive CCD-Chips available on the market provide an excellent color video image in editing quality even when the light is set for high-speed film stock to be pushed during processing.
- High resolution  
The design of the new IVS optics was based on the ARRIFLEX 235 viewfinder data and resulted in an image quality, which cannot be attained by add-on solutions.
- Flicker-free  
An integrated digital frame store enables the video camera to be synchronized to the film camera's mirror shutter and provides a flicker-free video image from 1 fps to maximum speed (in manual gain control mode) because the video image is always taken at the ideal position of the mirror shutter. Flicker free can be switched off to bypass the digital frame store and to have minimal delay in the video system.

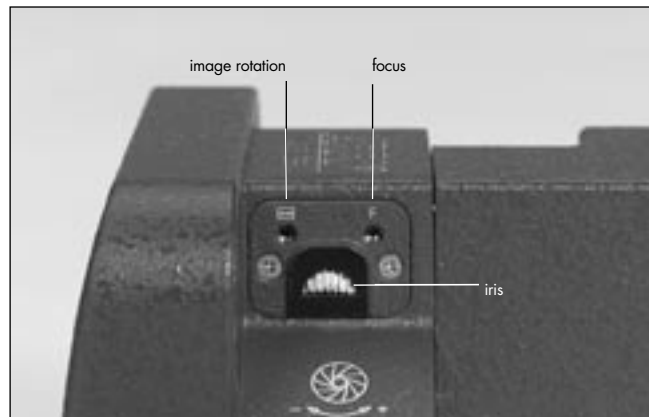

- **Full white balance control**  
In addition to the standard indoor white balance setting with 3200 K, an outdoor setting with 5600 K and an automatic adjustment, red and blue channel can be fine tuned for manual white balance
- **Line Interpolation**  
Even further resolution in camera run mode because of line interpolation, thus the image appears almost in field resolution.
- **Store and recall settings**  
All settings can be stored and recalled. By this, it is possible for example to trim all the settings for indoor shooting, store them, have some exterior scenes, go back indoor and call the old settings back.  
Up to 6 settings can be stored.
- **Integrated frame line inserter**  
Frame lines can be electronically added to the video image. This ensures that the lines are visible even in difficult conditions. The area outside the frame lines can be darkened electronically in 4 different steps to emphasize the important image area.
- **Camera status display**  
Camera status information, e.g. camera speed and film counter data are passed on a bus interface from the camera to the video assist and can be displayed in a camera status line on the monitor.
- **System display**  
Camera system information is available in the video assist. Thus, it is possible to see camera warnings such as movement open or low battery on the monitor.
- **Integrated text inserter**  
Additional text like take numbers or production name can be added to the video image by entering the text on the IVS.
- **Y/C Outputs**  
The usual composite outputs can be switched to an Y/C output (S-VHS) for an even better video image without annoying color artifacts, with or without data inserted into the video image. The output is on two BNC sockets.
- **On-Screen programming**  
All functions, which do not affect the image appearance directly, such as frame lines, can be conveniently programmed with an on-screen programming menu on the video monitor.

- **Dedicated controls**  
Important image changes such as gain or white balance can be done immediately in parallel to the on-screen programming with dedicated key.
- **Image compare function**  
It is possible to store a particular image and compare it against other images. This clearly shows the difference between the images, e.g. during stop effect shots.
- **Automatic and manual gain control**  
The gain is controlled automatically to its best value but can also be set manually.
- **Mini monitor connector**  
The IVS offers a connector for a 12 V LCD mini monitor with an even increased output power up to 1.5 A.

**Note:** The IVS package already includes a lens for Super 35, a 1.5 mm allen key for image adjustment and an Y/C (S-VHS) cable.

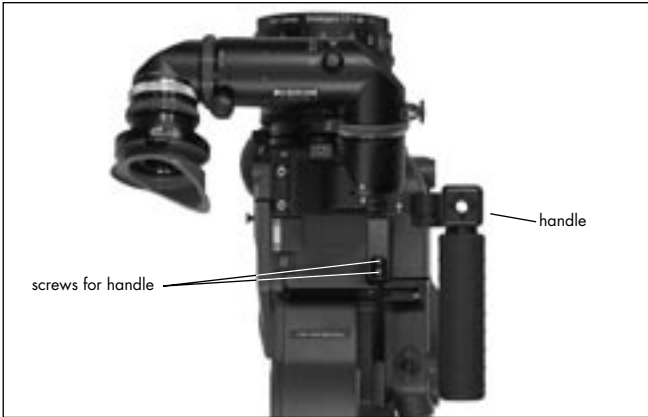

## 10.2 Setup

### 10.2.1 Installation

A 1.5 mm allen key and a 3 mm allen key are used. Take the handle and the transport cover off the camera.

- To take the handle off, open the two screws on the base of the handle ⇨ **photo** with a 3 mm allen key and remove the handle.
- To take the transport cover off, open the two screws ⇨ **photo** with a 3 mm allen key and remove the transport cover.

- To get the transport cover of the video assist off, open the screws on the IVS ⇨ **photo** with a 3 mm allen key and remove the transport cover to the rear.
- Pull off the plastic cover over the contacts.
- Attach the video assist onto the ARRIFLEX 235 by moving it in the marked direction. The wedge on the IVS should mate with the matching dovetail on the camera body ⇨ **photo**.

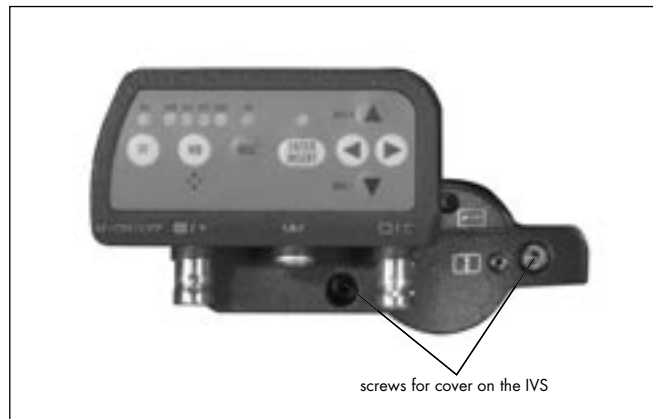
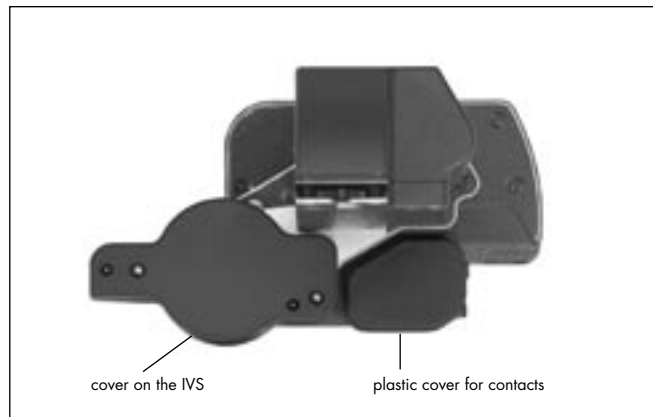

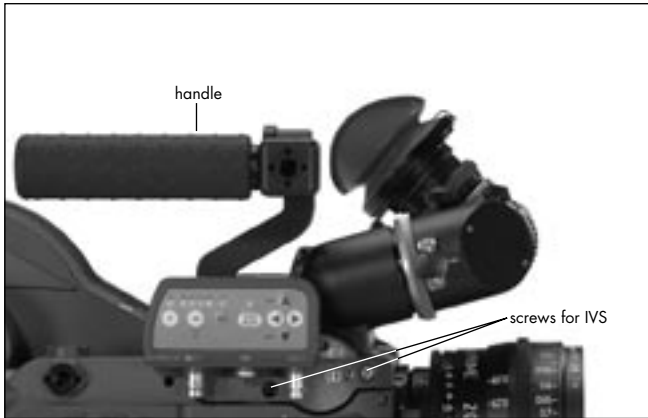

- Push the IVS as shown until the gap between the camera and the IVS closes.
- Close the screws on the IVS ⇨ **photo** with a 3 mm allen key.
- Remount the handle ⇨ **photo** and close the screws on the base of the handle with a 3 mm allen key.

## 10.2.2 Cabling

### Outputs



*In case the composite output should be used and it is unknown, whether the BNC connectors on the IVS are switched to composite or to Y/C, please connect the composite signal to the /Y first and check the settings (BNC OUT VBS or Y/C) in the menu video/text adjust. Please see next chapter Composite Video Outputs.*

The IVS has two BNC sockets, which can be switched to output two independent composite signals or one Y/C signal. Additionally, there is an output for a mini monitor



### Composite Video Outputs



*Composite video is only available if the output is switched to VBS out.*

- To switch to composite video (VBS mode), enter the main menu by pressing the Enter/Insert key  for more than 3 seconds. Go to sub menu VIDEO/TEXT ADJUST. The menu line BNC OUT can be switched between VBS and Y/C. See chapter 10.4 Inserter Facilities for information on the on-screen program mode.

The difference between the outputs is that there is normal video on the one connector and video with data on the other.

In the normal video output, marked with the /C symbol ⇨ **photo**, almost no electronic information is inserted. Only a rolling bar at the button left corner of the video image indicates a running film camera.

In the video with data output, marked with the /Y symbol ⇨ **photo**, additional data such as format marks or camera status information can be inserted.

The outputs are standard BNC sockets for 75 Ω terminated video signals. Both outputs can be used simultaneously.

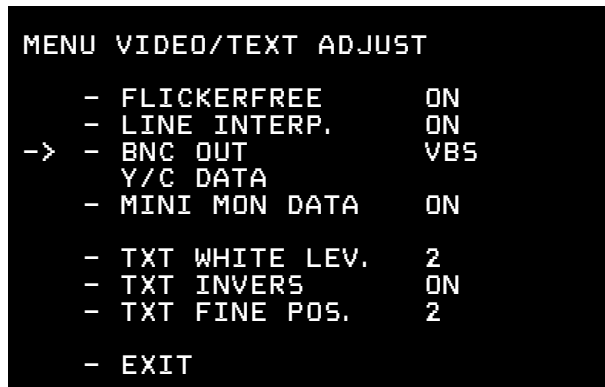

```
MENU VIDEO/TEXT ADJUST
- FLICKERFREE      ON
- LINE INTERP.    ON
-> - BNC OUT        Y/C
- Y/C DATA
- MINI MON DATA  ON

- TXT WHITE LEV.   2
- TXT INVERS       ON
- TXT FINE POS.    2

- EXIT
```

## Y/C Output

In comparison to the composite outputs, the Y/C outputs offer the even better S-VHS quality. There are also normal video and video with data signals available.



*Y/C video is only available if the output is switched to Y/C out.*

- Use the on-screen program mode to switch between composite and Y/C. Enter the main menu by pressing the Enter/Insert key  for more than 3 seconds. Go to sub menu VIDEO/TEXT ADJUST. The menu line BNC OUT can be switched between VBS and Y/C. See chapter 10.4 Inserter Facilities for information on the on-screen program mode.



There are normal video and video with data signals available from the same pair of connectors.

- To switch between normal video and video with data, use the on-screen program mode. Enter the main menu by pressing the Enter/Insert key  for more than 3 seconds. Go to sub menu VIDEO/TEXT ADJUST. The menu line Y/C DATA, which can only be reached if BNC OUT is on Y/C, switches between normal video and video with data on the Y/C signal. The line displays Y/C DATA ON or OFF.

See chapter 10.4 Inserter Facilities for information on the on-screen program mode.

In the normal video output almost no electronic information is inserted. Only a rolling bar at the lower left corner of the video image indicates a running film camera.

In the video with data output, additional data such as format marks or camera status information can be inserted.

An adapter from the two BNC connectors to a standard Y/C connector is included in the IVS package upon initial delivery. Connect the red end to the /C output and the white end to the /Y socket → **photo**.



```

MENU VIDEO/TEXT ADJUST
- FLICKERFREE          ON
- LINE INTERP.        ON
-> - BNC OUT            Y/C
- Y/C DATA           ON
- MINI MON DATA     ON

- TXT WHITE LEV.      2
- TXT INVERS          ON
- TXT FINE POS.       2

- EXIT
    
```

## Black and White Output

The Y part of the Y/C output is a standard black and white signal. To get black and white, use a standard BNC cable with 75 Ω connected to the /Y output and switch to Y/C out.



*Black and white or Y signal is only available if the output is switched to Y/C out.*

- Use the on-screen program mode to switch between composite and Y/C. Enter the main menu by pressing the Enter/Insert key  for more than 3 seconds. Go to sub menu VIDEO/TEXT ADJUST. The menu line BNC OUT can be switched between VBS and Y/C. See chapter 10.4 Inserter Facilities for information on the on-screen program mode.

There are normal video and video with data signals available from the same connector.

- To switch between normal video and video with data, use the on-screen program mode. Enter the main menu by pressing the Enter/Insert key  for more than 3 seconds. Go to sub menu VIDEO/TEXT ADJUST. The menu point Y/C DATA, which can only be reached if BNC OUT is on Y/C, switches between normal video and video with data on the Y/C signal. The line displays Y/C DATA ON or OFF. See chapter 10.4 Inserter Facilities for information on the on-screen program mode.

In the normal video output almost no electronic information is inserted. Only a rolling bar at the lower left corner of the video image indicates a running film camera.

In the video with data output, additional data such as format marks or camera status information can be inserted.

The /Y socket is standard BNC for 75  $\Omega$  video outputs  
⇨ **photo**.



```

MENU VIDEO/TEXT ADJUST

- FLICKERFREE      ON
- LINE INTERP.    ON
- BNC OUT          Y/C
- Y/C DATA        ON
-> - MINI MON DATA  ON

- TXT WHITE LEV.   2
- TXT INVERS       ON
- TXT FINE POS.    2

- EXIT
    
```

### Mini Monitor Output

The IVS has a connector for a standard mini-monitor.

As there is only one mini monitor connector, it is possible to switch between normal video and video with data on this output.

- To switch between normal video and video with data on the mini monitor output, use the on-screen program mode. Enter the main menu by pressing the Enter/Insert key  for more than 3 seconds. Go to sub menu VIDEO/TEXT ADJUST. The menu line MINI MON DATA can be switched OFF and ON. See chapter 10.4 Inserter Facilities for information on the on-screen program mode.

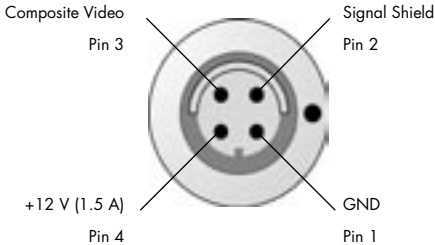
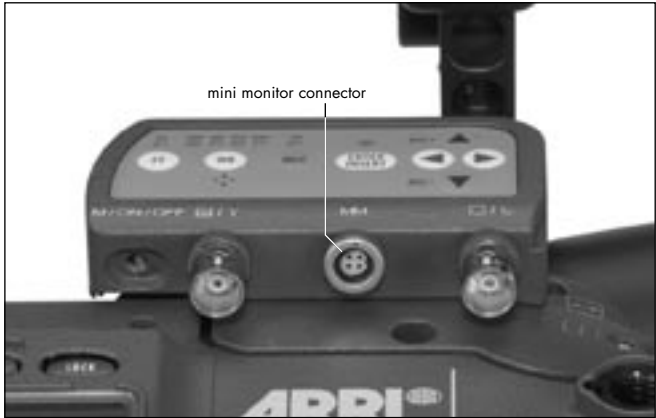

Pin-Outs Mini Monitor Connector (seen from outside)

## 10.3 Standard Video Controls

The IVS can be used like a standard video assist if no inserter features are used.

Note: All currently used settings are stored even if the IVS or the camera is switched off. After restarting the IVS the settings are unchanged, except for the image stored mode, which will always come up in live mode.

### 10.3.1 Switch On, Off and Check/Hide Menu

The IVS can be switched on and off independently from the film camera, as long as the film camera has power. Power off at the film camera will also shut the IVS down ⇨ **photo**.

- The OFF position switches the IVS off without affecting the film camera. ON activates the IVS.

#### Check Menu

If the on-screen program mode is off during normal operation, the Menu (M) position shows an overview of the IVS settings ⇨ **photo**.



```

CHECK

SETTING                2
WHITE BALANCE          IND
MANUAL GAIN             OFF
FLICKERFREE            ON
LINE INTERP.           ON
FORMAT                 1
VIEW MODE              LIVE
SYSTEM LINE            OFF
STATUS LINE            ON
USER TEXT LINE         ON
    
```

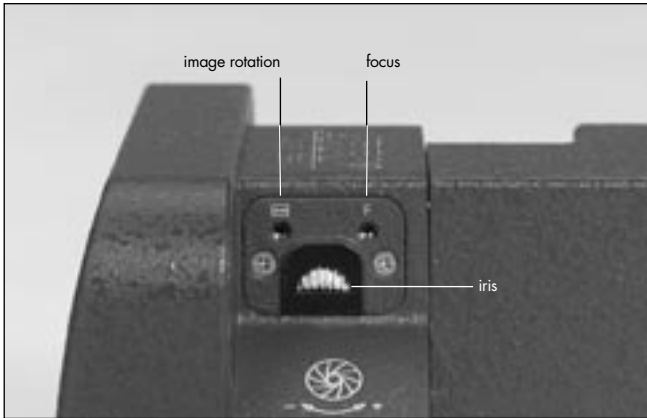

## Hide Menu

If the on-screen program mode is on because the settings are changed, the Menu (M) position clears the screen. For example, if color is to be changed with the on-screen program tool, the on-screen program window overlays the image. To see the image and its color appearance, go to M position. The window disappears but the on-screen program mode is still on. By releasing the switch, the window will come back in the programming mode.

## 10.3.2 Mechanical Iris

Only a relatively small portion of the light that passes through the film camera's lens reaches the CCD-Chip of the video assist, as the light is shared between the view finder, the CCD-Chip and the film. Therefore the IVS lenses are designed for normal usage with a totally open iris to have maximum light on the CCD-Chip. Variations in lighting are compensated by the IVS gain control (automatically or manually).

Under certain conditions, such as when lighting is set for low sensitivity film (under 100 ASA) or for motion effects, it is possible that the IVS gain range is exceeded. In this case the mechanical iris of the IVS lens can be closed.





*Check all settings on the connected monitor.*

If the mechanical iris is closed more than necessary, the IVS will compensate by increasing the gain and improve the image brightness electronically. This creates additional electronic noise. To avoid this, open the mechanical iris.

- To change the iris, turn the wheel with the iris symbol .



### 10.3.3 Alignment of the image position (X-, Y- and Rotation) and focus

The position of the image on the CCD-Chip and its focus can vary slightly from camera to camera. The video image on the monitor may appear not centered, rotated or out of focus.

All settings can be made by using a 1,5 mm allen key, which is delivered with the IVS.



*Do not use force!*

- Image position adjustments in x- and y- direction can be made with the marked x- and y- screws ⇔ **photo**.
- The screw, marked with  moves the video image on the monitor horizontally. The screw, marked with  vertically.

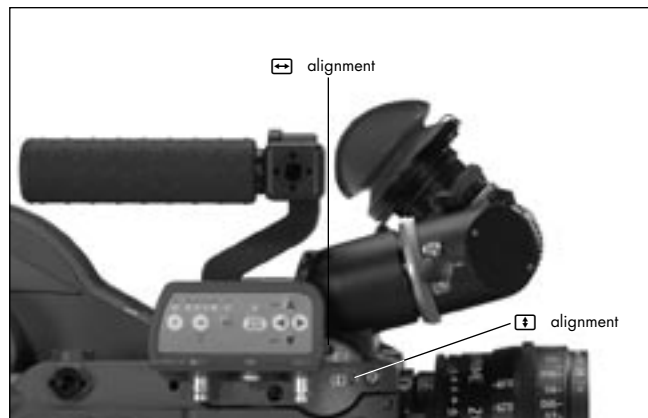

Note: Due to design restrictions in size, the axis might be not precisely in x- and y- direction

- Image rotation can be changed on the screw, marked with the -Symbol ⇔ **photo** (page 80).
- Focus can be changes, using the screw, which is marked with the F Symbol ⇔ **photo** (page 80).



### 10.3.4 White Balance (WB)

The IVS offers a choice for White Balance between









- an automatic control (AWB)
- fixed setting of indoor (IND)
- fixed setting for outdoor (OTD)
- and a full manual control of white balance (MAN).

White balance can be adjusted in two different ways. It is possible to control it using the keyboard on the IVS or using the on-screen control menu.

#### Using the Keyboard



*Check all settings on the connected monitor.*

- By pressing the WB key  ⇔ **photo**, the setting will be changed from AWB, IND, OTD to MAN. The corresponding LED is lit. The next click on the WB key  will cause the MAN LED to blink.
- Now, it is possible to change the red and blue channel using the color-coded , ,  and  keys. The next click on the WB key  or waiting longer than 5 seconds without pressing any key will cause the MAN LED to be constantly on. Another click on the WB key  will lead back to AWB. An illuminated LED shows the selected mode.
- If automatic White Balance (AWB) is selected, the IVS will automatically set White Balance. For this no manual steps are necessary ⇔ **photo**.
- If indoor (IND) is selected ⇔ **photo** white balance is optimized for tungsten lighting with 3200 K.
- The outdoor (OTD) setting ⇔ **photo** optimizes the white balance for daylight with 5600 K.







Note: With the MAN LED constantly on, no color settings can be made to avoid accidental handling.

Note: Changing red, blue and gain does changing green. The video signal is the addition of red, green and blue and amplified by the gain. Decreasing red and blue and lifted gain increases green.

## Using the on-screen menu

Please see chapter 10.4 Inserter Facilities for basics on the On-Screen display.

In parallel to the control via keyboard, the white balance can also be programmed via the on-screen menu.

- Enter the main menu by pressing the Enter/Insert key  for more than 3 seconds.  
Go to sub menu WB/GAIN. Move the cursor  with the keys  and  to the line - WHITE BALANCE. Pressing the key  will switch from Automatic White Balance (AWB), Indoor (IND) and Outdoor (OTD) to Manual (MAN) and back Automatic White Balance. The key  will give the opposite direction.
- If white balance is on manual, the display will change. Lines left of RED and BLUE will appear indicating that the red and green saturation of the video image can now be changed.

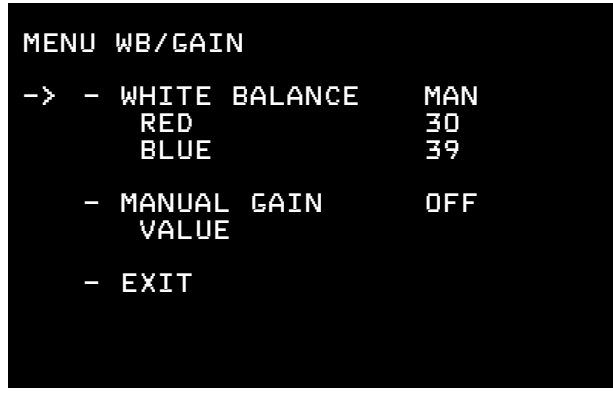
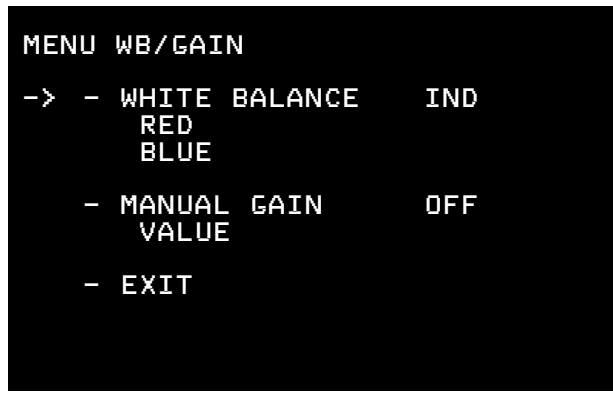

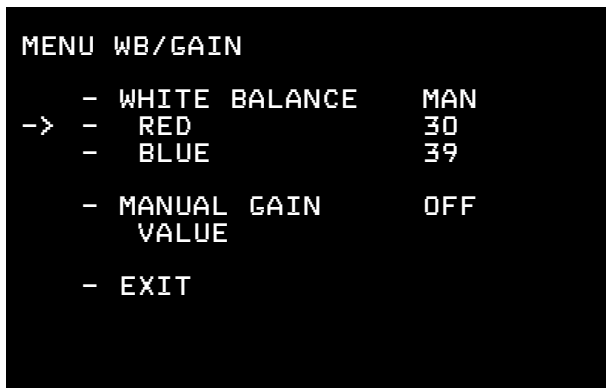

## Manual White Balance red increase/decrease



*Manual white balance red increase/decrease is only available if white balance control is on manual.*

If manual white balance is on MAN, it is possible to adjust the red and blue saturation of the video image manually.

- Move the cursor  $\rightarrow$  with the keys  $\uparrow$  and  $\downarrow$  to the line - RED. Pressing the key  $\rightarrow$  will increase the red in the video image; the key  $\leftarrow$  will decrease it.

The range for this is from 0 (lowest) to 63 (highest).

- If the key  $\rightarrow$  or  $\leftarrow$  is pressed shortly, the value is changes by one step, if the keys are pressed longer, the value will continue to change.

The LED in the keyboard will follow the changes which are made in this menu and vice versa, if this setting is changed via the keyboard, the on-screen menu will follow.

### Manual White Balance blue increase/decrease



*Manual white balance blue increase/decrease is only available if white balance control is on manual.*

If manual white balance is on MAN, it is possible to adjust the red and blue saturation of the video image manually.

- Move the cursor  $\rightarrow$  with the keys  $\uparrow$  and  $\downarrow$  to the line - BLUE. Pressing the key  $\rightarrow$  will increase the blue in the video image; the key  $\leftarrow$  will decrease it.

The range for this is from 0 (lowest) to 63 (highest).

- If the key  $\rightarrow$  or  $\leftarrow$  is pressed shortly, the value is changes by one step, if the keys are pressed longer, the value will continue to change.

The LED in the keyboard will follow the changes which are made in this menu and vice versa, if this setting is changed via the keyboard, the on-screen menu will follow.

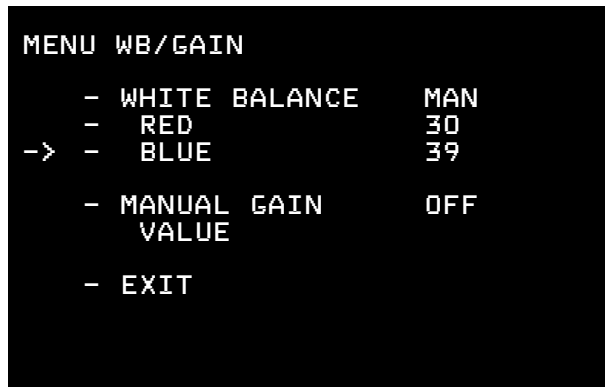



### 10.3.5 Gain Control

The IVS can change the brightness of the video image electronically. This gain control can be automatic or manual.

If the automatic control is selected, the IVS outputs the best possible image brightness at all the time. Light changes in front of the film camera are compensated by the IVS; the brightness impression remains almost unchanged.

Gain control can be adjusted in two different ways. It is possible to control it using the keyboard on the IVS or using the on-screen control menu.

### Using the Keyboard









*Check all settings on the connected monitor.*

- By pressing the WB key **WB** the setting alters between manual and automatic control. An illuminated LED shows the setting manual gain control (MGC) ⇄ **photo**.
- If manual gain control is selected (LED is on), the brightness of the video image can be manually altered. By using the **▲** or **▼** key brightness can be increased or decreased. An automatic compensation of different light levels in front of the camera is suppressed.

### Using the on-screen menu

Please see chapter 10.4 Inserter Facilities for basics on the On-Screen display.

In parallel to the control via keyboard, the manual gain control can also be programmed via the on-screen menu. Manual gain control can be switched on or off. If it is on, specific values can be set between 0 (low gain) and 63 (high gain).

- Enter the main menu by pressing the Enter/Insert key  for more than 3 seconds. Go to sub menu WB/GAIN. Move the cursor  with the keys  and  to the line - MANUAL GAIN. Pressing the key  or  will switch manual gain control off and on. If manual gain control is on, the display will change. A line symbol - will appear before VALUE indicating that the gain can be changes manually.

The LED in the keyboard will follow the changes which are made in this menu and vice versa, if this setting is changed via the keyboard, the on-screen menu will follow.

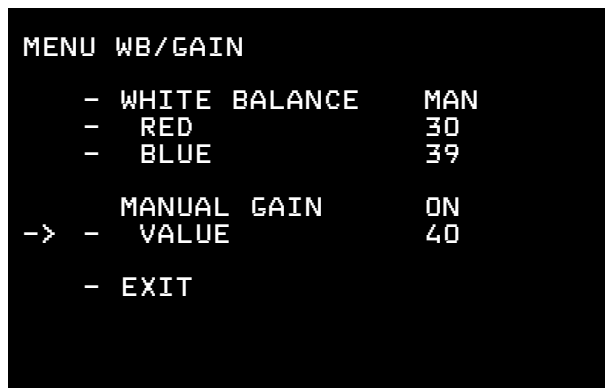
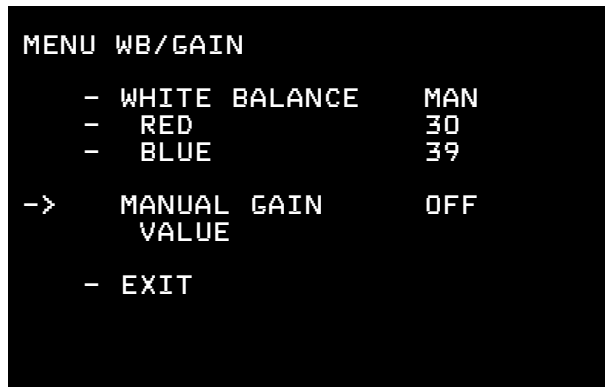

```
MENU WB/GAIN
- WHITE BALANCE MAN
- RED 30
- BLUE 39
-> - MANUAL GAIN ON
- VALUE 40
- EXIT
```

## Manual Gain increase/decrease



*Manual gain increase/decrease is only available if manual gain control is on.*

- Move the cursor  $\rightarrow$  with the keys  $\uparrow$  and  $\downarrow$  to the line - VALUE. Pressing the key  $\rightarrow$  will increase the gain; the key  $\leftarrow$  will decrease it.

The range for this is from 0 (lowest gain) to 63 (highest gain).

- If the key  $\rightarrow$  or  $\leftarrow$  is pressed shortly, the value is changes by one step, if the keys are pressed longer, the value will continue to change.

The LED in the keyboard will follow the changes which are made in this menu and vice versa, if this setting is changed via the keyboard, the on-screen menu will follow.



### 10.3.6 Flicker free on/off

Flicker free can be switched off to bypass the digital frame store and have the video assist output with no delay.

The film camera runs normally at a different speed than the video assist. E.g. the film camera runs at 24 fps and the video assist at 25 fps for PAL or 30 fps for NTSC. This would normally cause different brightness of the individual video image. To eliminate this so called flicker, video images are stored at the speed of the film camera into the video frame storage and recalled in the speed of the video system. This storage might cause a slight delay, which is not desirable in some crucial time conditions, e.g. motion control or shooting of a pop video. Therefore it is possible to switch the flicker free system off. This will eliminate the delay. However, flicker will occur in this mode.

#### Using the Keyboard

- By pressing the FF key (Ⓢ) the flicker free mode alters between on and off. An illuminated LED shows the setting flicker free (FF) on ⇨ **photo**.



## MENU VIDEO/TEXT ADJUST

```
-> - FLICKERFREE      ON
    - LINE INTERP.   ON
    - BNC OUT        VBS
      Y/C DATA
    - MINI MON DATA ON







    - TXT WHITE LEV. 2
    - TXT INVERS      ON
    - TXT FINE POS.   5

    - EXIT
```

### Using the on-screen menu

Please see chapter 10.4 Inserter Facilities for basics on the On-Screen display.

In parallel to the control via keyboard, the flicker free off can also be programmed via the on-screen menu.

- Enter the main menu by pressing the Enter/Insert key  for more than 3 seconds. Go to sub menu VIDEO/TEXT ADJUST. Move the cursor  with the keys  and  to the line - FLICKERFREE. Pressing the key  or  will switch flicker free mode off and on.

Note: The lowest camera speed for flicker free display is 5 fps in automatic gain control mode and 1 fps in manual gain control mode.

### 10.3.7 Changing Format marking number

The IVS can insert different format markings. It is possible to have



- no format marking (OFF),
- format marking number one (1),
- format marking number two (2)
- or both format markings at the same time (1 & 2) on display.

#### Using the Keyboard



*The adjustment of the different format markings can only be done via the on-screen display as described in chapter 10.4.6 Format Marking Menu. However, it is possible to select which format markings are displayed via the keyboard.*

The format marking selection is only available, when the White Balance manual mode is not active (when the WB MAN LED is not flashing). If white balance manual mode is active, please wait for more than 5 seconds without pressing any key to leave this mode.

- The key  will switch from OFF, 1, 2 to 1&2. The key  will switch in opposite order.









```
MENU FORMAT MARKING
-> - FORMAT                OFF
    POSITION 1  ⏏
    POSITION 1  ⏏
    POSITION 2  ⏏
    POSITION 2  ⏏
    WHITE LEVEL
    OUTSIDE
- EXIT
```

## Using the on-screen menu

Please see chapter 10.4 Inserter Facilities for basics on the On-Screen display.



In parallel to the control via keyboard, the format marking number can also be programmed via the on-screen menu.

- Enter the main menu by pressing the Enter/Insert key  for more than 3 seconds. Go to sub menu FORMAT MARKING. Move the cursor  with the keys  and  to the line - FORMAT. Pressing the key  will switch from OFF, 1, 2 to 1&2. The key  will switch in opposite order.

### 10.3.8 Storing a video image

The IVS can store one particular image, display that or overlay it against the live image in front of the camera to compare both images. Although the functions to display a stored image and to compare a stored image against a live image are only available in the on-screen program mode, it is possible to store an image any time using the Enter/Insert key .

#### Using the Keyboard







- Pressing the Enter/Insert key  shortly (less than 1.5 seconds) will store an image in the frame store.
- Every time when the Enter/Insert key  is shortly pressed, a new image is stored.
- To view the stored image, or to compare it against a live image, please enter the on-screen program mode, as described in chapter 10.4.7 Display mode



```
MENU COMPARE/STORE
  - VIEW MODE          LIVE
-> - STORE IMAGE
  - CLEAR IMAGE
  - EXIT
```

## Using the on-screen menu

Please see chapter 10.4 Inserter Facilities for basics on the On-Screen display.

- Enter the main menu by pressing the Enter/Insert key  for more than 3 seconds. Go to sub menu COMPARE/STORE. Move the cursor  with the keys  and  to the line - STORE IMAGE. Pressing the key  or  will store the image. The word **DONE** will appear for a few seconds to show that an image was stored.

The stored image is memorized until a new image is stored, the image is cleared or until the IVS power was shot down.

## 10.4 Inserter Facilities

In addition to the usual video assist functions, the IVS offers a variety of inserter facilities. There are two different groups of information:

- Format markings  
Format markings, which are inserted electronically, are often more visible than format markings on the ground glass.
- Man readable information  
Camera status  
System line  
Additional text



*All inserted data are only available at the outputs Video with data.  
All engravings from the ground glass (e. g. TV-Safe etc.) are visible at all times at all outputs.*

**Note:** All currently used settings are stored even if the IVS or the camera is switched off or disconnected from the power supply. After restarting the IVS the settings are unchanged, except for the image stored mode, which will always come up in live mode.









### 10.4.1 Setting the On-Screen Displays



*During programming the inserted data are not fully updated (e. g. Frame Counter Information). To get information updated, leave the on-screen display menu by pressing the Enter/Insert key  for more than three seconds.*

Once the on-screen display is activated by pressing the Enter/Insert key  for more than three seconds, the following procedure is used to select and set all functions within the main menu and the sub menus:

- Pressing the key  or  will move the cursor  up or down. Pressing the key  or  activates sub menus.

- Within sub menus the cursor  $\blacktriangleright$  can be moved up and down again by pressing the key  $\blacktriangle$  or  $\blacktriangledown$ . The keys  $\blacktriangleright$  or  $\blacktriangleleft$  will now change settings (e. g. switch the insertion of a user text window on and off), or activates functions (position mode of a window or EXIT).
- If the windows position mode is activated, the keys  $\blacktriangle$  or  $\blacktriangledown$  will move the window across the video image. To leave the position mode press the Enter/Insert key  shortly.
- To go from a sub menu back to the main menu, position the cursor  $\blacktriangleright$  by using the keys  $\blacktriangle$  and  $\blacktriangledown$  on the line EXIT and press the key  $\blacktriangleright$  or  $\blacktriangleleft$ .
- Active lines are marked with a dash symbol –. They can be reached with the cursor  $\blacktriangleright$  within a menu using the keys  $\blacktriangle$  and  $\blacktriangledown$ . Lines may not be active because the currently selected mode does not use this feature. E.g. when gain is not in manual control mode, the line value is not active because value cannot be changed in the automatic control mode. In this case, no dash symbol – is displayed and the line cannot be reached with the cursor  $\blacktriangleright$ . To activate this line, switch from automatic to manual gain control mode.





*Changing them immediately activates all settings.*





Note: Pressing the Enter/Insert key  for more than three seconds will cause the system to exit the on-screen programming mode completely, regardless of which menu is activated, with the exception of the positioning mode.



## 10.4.2 Main Menu

The inserter's main menu is displayed on the monitor screen when the on-screen programming is activated by pressing the Enter/Insert key  for more than three seconds. An illuminated LED indicates that the on-screen programming is activated.

Note: Pressing the Enter/Insert key  for more than three seconds will cause the system to exit the on-screen programming mode completely, regardless of which menu is activated, with the exception of the positioning mode.

- The keys  or  move the cursor  up or down. Pressing the key  or  will lead into a sub menu.



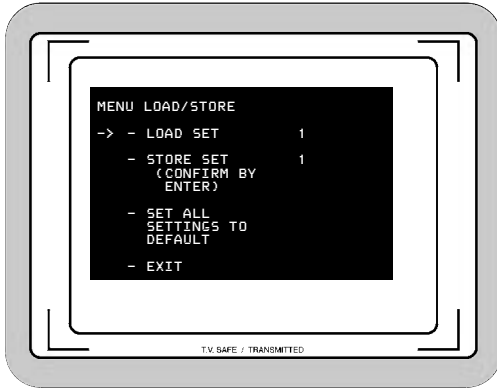

## 10.4.3 Load/Store Menu

The IVS can store up to 6 sets of settings and recall them. Thus it is possible to make all settings for e.g. indoor shooting and store them as setting 1. Shooting continues with some exterior scenes and the operator will make all settings for this and store them as setting 2. When the work is continued indoor, it is very easy recalling all the settings stored as setting 1 and get the same image appearance as before.

One set of settings consists of all set-ups in the IVS. Everything which can be set electronically, will be stored and recalled. All video adjustments such as manual gain control, white balance, flicker free, outputs with or without data and line interpolation as well as all inserter setups, e.g. user text insertion off or on, frame lines and so on are stored and recalled.

The adjustment of the white level of the inserted data, an inverse display and a fine adjustment of the vertical position is described in chapters 10.4.5 White Level, Inverse and Fine Positioning.



*Changing them immediately activates all settings. Check all settings on the connected monitor.*

- Enter the Load/Store submenu from the main menu.

## Load Settings

It is possible to load one out of six settings. Those new settings will influence all adjustments that can be made electronically.



*The new settings will immediately replace the previous settings. If the old settings might be needed, store them first as described in the next chapter Store Settings.*

- Move the cursor  $\rightarrow$  with the keys  $\uparrow$  and  $\downarrow$  to the line – LOAD SET. Pressing the key  $\rightarrow$  will switch from 1 to 2 all the way up to 6 and back to 1, the key  $\leftarrow$  will switch in the opposite direction. Pressing either the key  $\rightarrow$  or  $\leftarrow$ , will immediately load the new settings.

## Store Settings

The set of settings, that are currently active, can be stored as one out of six settings.

- Move the cursor  $\rightarrow$  with the keys  $\uparrow$  and  $\downarrow$  to the line – STORE SET. Pressing the key  $\rightarrow$  will switch from 1 to 2 all the way up to 6 and back to 1, the key  $\leftarrow$  will switch in the opposite direction.
- When the demanded number was reached, press the Enter/Insert key  to store this setting under the given number. The word **DONE** will appear for 3 seconds to indicate that the setting was stored. After this, the display will return to its normal mode.

### MENU LOAD/STORE

```

-> - LOAD SET          4
    - STORE SET      4
      (CONFIRM BY
        ENTER)
    - SET ALL
      SETTINGS TO
      DEFAULT
    - EXIT
  
```

### MENU LOAD/STORE

```

    - LOAD SET          4
-> - STORE SET      4
      (CONFIRM BY
        ENTER)
    - SET ALL
      SETTINGS TO
      DEFAULT
    - EXIT
  
```

```
MENU LOAD/STORE
- LOAD SET          4
- STORE SET          4
  (CONFIRM BY
  ENTER)
-> - SET ALL
    SETTINGS TO
    DEFAULT
- EXIT
```

```
ARE YOU SURE?
(NO UNDO)
-> - NO
- YES
- EXIT
```

### All Standard



*After the function set all settings to default was called, all settings are cleared. They cannot be recalled.*

This menu recalls a default setting of all values. By this, it is possible to obtain basic setting for the IVS.

- Move the cursor  $\rightarrow$  with the keys  $\uparrow$  and  $\downarrow$  to the line – SET ALL. Pressing the key  $\rightarrow$  or  $\leftarrow$  recalls the default values.
- It is necessary to confirm that procedure, as all settings will be cleared. This window will appear with the cursor  $\rightarrow$  in the line NO. Pressing the key  $\rightarrow$  or  $\leftarrow$  will cancel this procedure.
- To clear everything, move the cursor  $\rightarrow$  with the keys  $\uparrow$  and  $\downarrow$  to the line – YES. Pressing the key  $\rightarrow$  or  $\leftarrow$  sets all settings to default.
- If the cursor  $\rightarrow$  is in position EXIT and the key  $\rightarrow$  or  $\leftarrow$  is pressed, the IVS will return to the Load/Store menu without setting everything to default.

**The default values are:**

WB = INDOOR  
 Manual Gain with GAIN = 0  
 Flicker free = ON  
 Line Interpolation = ON  
 Y/C data = ON  
 BNC OUT = VBS  
 Mini-Monitor Data = ON  
 Format 1 = ON  
 Format 2 = OFF  
 WHITE LEVEL frame lines = 2  
 OUTSIDE AREA = DARK  
 VIEW MODE = Live (Frame store is cleared)  
 SYSTEM ZEILE = ON  
 STATUS ZEILE = ON  
 Background STATUS/SYSTEM = boxed  
 Film counter ON and on FOOTAGE  
 USER TEXT LINE OFF  
 Background User Text line = boxed  
 Size = Small  
 White Level Text = 2  
 Inverse = OFF  
 Vert Pos = 5

## MENU LOAD/STORE

```

- LOAD SET          4
- STORE SET        4
  (CONFIRM BY
  ENTER)
- SET ALL
  SETTINGS TO
  DEFAULT
-> - EXIT
  
```

**Exit**

Use exit to return to the main menu.

- Move the cursor  $\rightarrow$  with the keys  $\uparrow$  and  $\downarrow$  to the line -EXIT and press the key  $\rightarrow$  or  $\leftarrow$ .

Note: Pressing the Enter/Insert key  for more than three seconds will cause the system to exit the on-screen programming mode completely, regardless of which menu is activated, with the exception of the positioning mode.

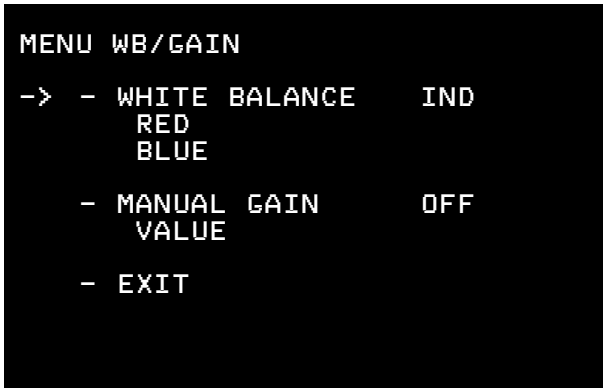
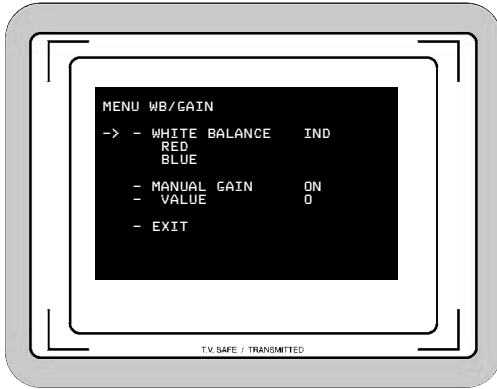

## 10.4.4 White Balance (WB) and Manual Gain Control (MGC) Menu

White balance and manual gain control allows to change the color appearance and brightness of the video image.



*Changing them immediately activates all settings. Check all settings on the connected monitor.*

- Enter the WB/Gain submenu from the main menu.

### White Balance (Indoor/Outdoor/Automatic/Manual)

In parallel to the control via keyboard, the white balance can also be programmed via the on-screen menu. It toggles from Indoor, Outdoor and Automatic to Manual.

- Move the cursor  $\rightarrow$  with the keys  $\uparrow$  and  $\downarrow$  to the line - WHITE BALANCE. Pressing the key  $\rightarrow$  will switch from Automatic White Balance (AWB), Indoor (IND) and Outdoor (OTD) to Manual (MAN) and back Automatic White Balance. The key  $\leftarrow$  will give the opposite direction.

- If white balance is on manual, the display will change. Lines left of RED and BLUE will appear indicating that the red and green saturation of the video image can now be changed.

### Manual White Balance red increase/decrease



*Manual white balance red increase/decrease is only available if white balance control is on manual.*

If manual white balance is on MAN, it is possible to adjust the red and blue saturation of the video image manually.

- Move the cursor  $\rightarrow$  with the keys  $\uparrow$  and  $\downarrow$  to the line - RED. Pressing the key  $\rightarrow$  will increase the red in the video image; the key  $\leftarrow$  will decrease it.

The range for this is from 0 (lowest) to 63 (highest).

- If the key  $\rightarrow$  or  $\leftarrow$  is pressed shortly, the value is changes by one step, if the keys are pressed longer, the value will continue to change.

The LED in the keyboard will follow the changes which are made in this menu and vice versa, if this setting is changed via the keyboard, the on-screen menu will follow.

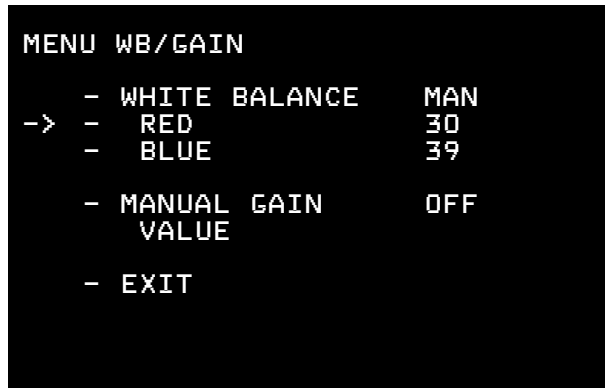
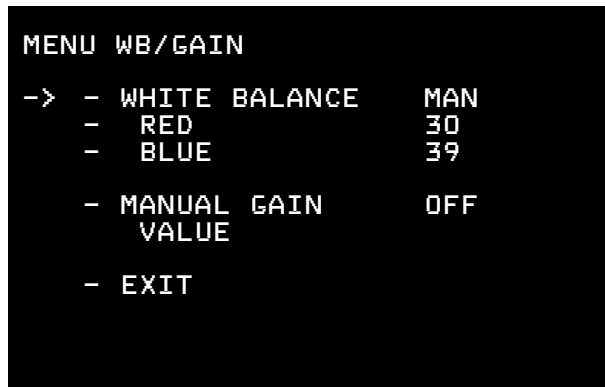

```
MENU WB/GAIN
  - WHITE BALANCE   MAN
  - RED             30
-> - BLUE           39
  - MANUAL GAIN     OFF
    VALUE
  - EXIT
```

## Manual White Balance blue increase/decrease



*Manual white balance blue increase/decrease is only available if white balance control is on manual.*

If manual white balance is on MAN, it is possible to adjust the red and blue saturation of the video image manually.

- Move the cursor  $\rightarrow$  with the keys  $\uparrow$  and  $\downarrow$  to the line - BLUE. Pressing the key  $\rightarrow$  will increase the blue in the video image; the key  $\leftarrow$  will decrease it.

The range for this is from 0 (lowest) to 63 (highest).

- If the key  $\rightarrow$  or  $\leftarrow$  is pressed shortly, the value is changes by one step, if the keys are pressed longer, the value will continue to change.

The LED in the keyboard will follow the changes which are made in this menu and vice versa, if this setting is changed via the keyboard, the on-screen menu will follow.



## Manual Gain Control On/OFF

In parallel to the control via keyboard, the manual gain control can also be programmed via the on-screen menu. Manual gain control can be switched on or off. If it is on, specific values can be set between 0 (low gain) and 63 (high gain). If it is off, an automatic mode is active.

- Move the cursor  $\rightarrow$  with the keys  $\uparrow$  and  $\downarrow$  to the line - MANUAL GAIN. Pressing the key  $\rightarrow$  or  $\leftarrow$  will switch manual gain control off and on. If manual gain control is on, the display will change. A line symbol - will appear before VALUE indicating that the gain can be changes manually.

The LED in the keyboard will follow the changes which are made in this menu and vice versa, if this setting is changed via the keyboard, the on-screen menu will follow.

```

MENU  WB/GAIN
      -  WHITE  BALANCE  IND
        RED
        BLUE
-> -  MANUAL  GAIN      OFF
      VALUE
      -  EXIT
  
```

```

MENU  WB/GAIN
      -  WHITE  BALANCE  IND
        RED
        BLUE
-> -  MANUAL  GAIN      ON
      VALUE            40
      -  EXIT
  
```

```
MENU WB/GAIN
- WHITE BALANCE   IND
  RED
  BLUE
- MANUAL GAIN     ON
-> - VALUE        40
- EXIT
```

## Manual Gain increase/decrease



*Manual gain increase/decrease is only available if manual gain control is on.*

If manual gain is on, it is possible to adjust the gain manually.

- Move the cursor  $\rightarrow$  with the keys  $\uparrow$  and  $\downarrow$  to the line - VALUE. Pressing the key  $\rightarrow$  will increase the gain; the key  $\leftarrow$  will decrease it.

The range for this is from 0 (lowest gain) to 63 (highest gain).

- If the key  $\rightarrow$  or  $\leftarrow$  is pressed shortly, the value is changes by one step, if the keys are pressed longer, the value will continue to change.

The LED in the keyboard will follow the changes which are made in this menu and vice versa, if this setting is changed via the keyboard, the on-screen menu will follow.

### Exit

Use exit to return to the main menu.

- Move the cursor ➤ with the keys ▲ and ▼ to the line  
– EXIT and press the key ▶ or ◀.

Note: Pressing the Enter/Insert key  for more than three seconds will cause the system to exit the on-screen programming mode completely, regardless of which menu is activated, with the exception of the positioning mode.

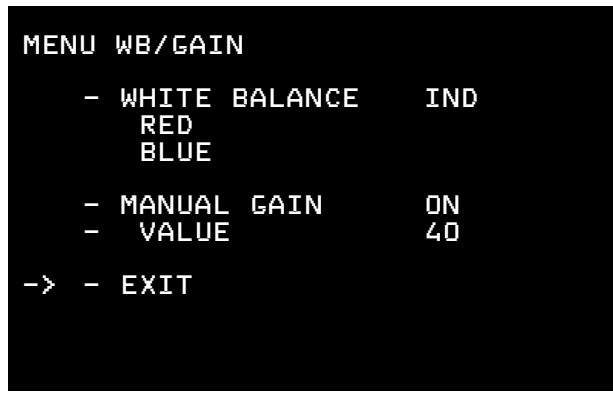

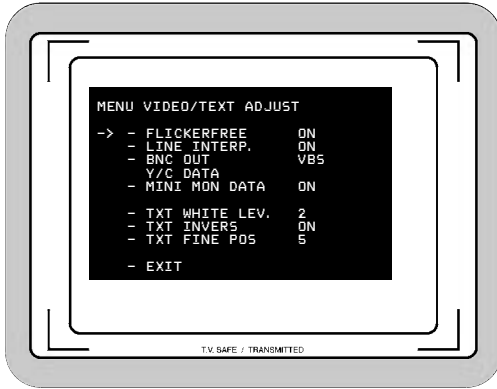

## 10.4.5 Video and Text Adjustment Menu

This sub menu allows to change basic video settings as well as the appearance of the inserted man readable text.



*Changing them immediately activates all settings. Check all settings on the connected monitor.*

- Enter the Video/Text Adjust submenu from the main menu.

### Flicker free on/off

Flicker free can be switched off to bypass the digital frame store and have the video assist output with no delay.

The film camera runs normally at a different speed than the video assist. E.g. the film camera runs at 24 fps and the video assist at 25 fps for PAL or 30 fps for NTSC. This would normally cause different brightness of the video image. To eliminate this so called flicker, video images are stored at the speed of the film camera into the video frame storage and recalled in the speed of the video system. This storage might cause a slight delay, which is not desirable in some crucial time conditions, e.g. motion control or shooting of a pop video. Therefore it is possible to switch the flicker free system off. This will eliminate the delay. However, flicker will occur in this mode.

In parallel to the control via keyboard, the flicker free off can also be programmed via the on-screen menu.

- Move the cursor ➤ with the keys ▲ and ▼ to the line – FLICKERFREE. Pressing the key ► or ◀ will switch flicker free mode off and on.

Note: The lowest camera speed for flicker free display is 5 fps in automatic gain control mode and 1 fps in manual gain control mode.

### Line interpolation on/off

Due to the rotating mirror shutter of the film camera, the CCD chip of the IVS gets light only for maximal 50 % of the time. All video assists will therefore have one true video field and the next one will be the repetition of the previous one. So the repeated video field does not have new information. To improve this situation, the video assist can be electronically enhanced with a so-called line interpolation.

- Move the cursor ➤ with the keys ▲ and ▼ to the line – LINE INTERP.. Pressing the key ► or ◀ will switch the line interpolation on and off.

Note: This setting affects only the video image while the film camera is in run mode.

```
MENU VIDEO/TEXT ADJUST
-> - FLICKERFREE      ON
    - LINE INTERP.   ON
    - BNC OUT        VBS
      Y/C DATA
    - MINI MON DATA  ON

    - TXT WHITE LEV.  2
    - TXT INVERS      ON
    - TXT FINE POS    5

    - EXIT
```

```
MENU VIDEO/TEXT ADJUST
-> - FLICKERFREE      ON
    - LINE INTERP.   ON
    - BNC OUT        VBS
      Y/C DATA
    - MINI MON DATA  ON

    - TXT WHITE LEV.  2
    - TXT INVERS      ON
    - TXT FINE POS    5

    - EXIT
```

```

MENU VIDEO/TEXT ADJUST
- FLICKERFREE          ON
- LINE INTERP.         ON
-> - BNC OUT             VBS
  Y/C DATA
- MINI MON DATA      ON

- TXT WHITE LEV.       2
- TXT INVERS           ON
- TXT FINE POS         5

- EXIT
  
```

```

MENU VIDEO/TEXT ADJUST
- FLICKERFREE          ON
- LINE INTERP.         ON
-> - BNC OUT             VBS
  Y/C DATA            ON
- MINI MON DATA      ON

- TXT WHITE LEV.       2
- TXT INVERS           ON
- TXT FINE POS         5

- EXIT
  
```

### Composite or Y/C signal at BNC Connectors

The IVS has two BNC sockets, which can be switched to output two independent composite signals or one Y/C signal. If selected, the Y/C signal is available on the same BNC connectors, on which the composite signal is outputted. Therefore it is necessary to switch between both signals on the BNC connector.

- Move the cursor  $\rightarrow$  with the keys  $\uparrow$  and  $\downarrow$  to the line – BNC-OUT. Pressing the key  $\rightarrow$  or  $\leftarrow$  will switch the output signal on the BNC connector between composite (VBS) and Y/C
- If Y/C is selected a line symbol – will appear before Y/C DATA indicating that the Y/C output can now be switched between normal video and video with data.

### Y/C signal with or without data

There are normal video and video with data signals available from the same pair of connectors. Therefore it is necessary to switch between the two types of video.

- Move the cursor  $\rightarrow$  with the keys  $\uparrow$  and  $\downarrow$  to the line – Y/C DATA. Pressing the key  $\rightarrow$  or  $\leftarrow$  will switch between normal video and video with data in the Y/C signal. The line displays Y/C DATA ON or OFF.

## Mini-Monitor Output as normal video or video with data

The mini monitor output can be programmed to have normal video or video with data.



*If the on-screen menu control is on (red LED next to the Enter/Insert key  is on), there will always be data in this output. This is necessary because if the output is switched to data off, no insert were available and therefore, it would be impossible to go back into the on-screen menu to change the settings.*

- Move the cursor  $\rightarrow$  with the keys  $\uparrow$  and  $\downarrow$  to the line - MINI MON DATA. Pressing the key  $\rightarrow$  or  $\leftarrow$  will switch insertion of data in the mini monitor ON and OFF.

## White Level

This line is used to change the brightness of all man-readable windows but the frame lines. Value 0 means dark gray, value 3 corresponds to bright white characters.

- Move the cursor  $\rightarrow$  with the keys  $\uparrow$  and  $\downarrow$  to the line - TXT WHITE LEV.. By pressing the key  $\rightarrow$  the values for the brightness of the characters will increment beginning from 0 to 3, and after that back to 0. The key  $\leftarrow$  will decrement in the opposite direction.

```
MENU VIDEO/TEXT ADJUST

- FLICKERFREE      ON
- LINE INTERP.    ON
- BNC OUT          VBS
- Y/C DATA        ON
-> - MINI MON DATA ON

- TXT WHITE LEV.   2
- TXT INVERS       ON
- TXT FINE POS     5

- EXIT
```

```
MENU VIDEO/TEXT ADJUST

- FLICKERFREE      ON
- LINE INTERP.    ON
- BNC OUT          VBS
- Y/C DATA        ON
- MINI MON DATA   ON

-> - TXT WHITE LEV.   2
- TXT INVERS       ON
- TXT FINE POS     5

- EXIT
```

## MENU VIDEO/TEXT ADJUST

```

- FLICKERFREE      ON
- LINE INTERP.    ON
- BNC OUT         VBS
- Y/C DATA       ON
- MINI MON DATA  ON

- TXT WHITE LEV.   2
-> - TXT INVERS     ON
- TXT FINE POS     5

- EXIT

```

## MENU VIDEO/TEXT ADJUST

```

- FLICKERFREE      ON
- LINE INTERP.    ON
- BNC OUT         VBS
- Y/C DATA       ON
- MINI MON DATA  ON

- TXT WHITE LEV.   2
-> - TXT INVERS     ON
- TXT FINE POS     5

- EXIT

```

**Inverse**

This menu changes the appearance of all man-readable windows. The format markings are not changed. If inverse OFF is selected, the characters will appear white. If the background is BOXED it will appear black in this case. If inverse ON is selected, the characters will appear black. If the background is BOXED it will appear white in this case.

- Move the cursor  $\rightarrow$  with the keys  $\uparrow$  and  $\downarrow$  to the line – INVERSE. The keys  $\rightarrow$  or  $\leftarrow$  will switch between ON and OFF.

**Fine Positioning**

By changing the setting in the line Fine Position of this submenu it is possible to simultaneously shift all man-readable windows vertically by one video line (fine adjust). The single steps are smaller than the steps in the normal position mode. This will place all windows as far outside the actual image area as possible. Format markings are not moved.

- Move the cursor  $\rightarrow$  with the keys  $\uparrow$  and  $\downarrow$  to the line – FINE POS.. By pressing the key  $\rightarrow$  the value will increment starting from 0 to 9, after that it will go back to 0. Higher values will cause the windows to be at a higher video line. They will therefore appear lower on the video screen. The key  $\leftarrow$  will increment in the opposite direction.



### Exit

Use exit to return to the main menu.

- Move the cursor  $\rightarrow$  with the keys  $\uparrow$  and  $\downarrow$  to the line -EXIT and press the key  $\rightarrow$  or  $\leftarrow$ .

Note: Pressing the Enter/Insert key  for more than three seconds will cause the system to exit the on-screen programming mode completely, regardless of which menu is activated, with the exception of the positioning mode.

```
MENU VIDEO/TEXT ADJUST

- FLICKERFREE      ON
- LINE INTERP.    ON
- BNC OUT          VBS
- Y/C DATA        ON
- MINI MON DATA  ON

- TXT WHITE LEV.   2
- TXT INVERS       ON
- TXT FINE POS     5

-> - EXIT
```



## 10.4.6 Format Marking Menu

The IVS can insert two different format markings electronically in the video image, either individually or simultaneously. The position of these format markings can be set anywhere on the screen, to line up exactly with the ground glass markings. The brightness is adjustable in four steps and the area outside of one format marking can be electronically darkened.



*Changing them immediately activates all settings.  
Check all settings on the connected monitor.*

- Enter the Format Marking submenu from the main menu.

## Activate Format Markings

If the electronic format markings are not parallel to the ground glass format markings, readjust the CCD chip with the alignment screw, as shown in chapter 10.3.3 Alignment of the image position (X-, Y- and Rotation) and focus

Note: Only active frame lines can be positioned. If no frame line is on (FORMAT OFF), no position line can be reached with the cursor  $\rightarrow$ . If Format 1 is on, only – POSITION 1 can be reached with the cursor  $\rightarrow$ . Only if format 1 & 2 is selected, all - POSITION lines can be used.

It is possible to have no format marking (OFF), format marking number one (1), format-marking number two (2) or both format markings at the same time (1 & 2) on display.

- Move the cursor  $\rightarrow$  with the keys  $\uparrow$  and  $\downarrow$  to the line – FORMAT. Pressing the key  $\rightarrow$  will switch from OFF to 1 to 2 to 1 & 2 and back to OFF, the key  $\leftarrow$  will switch in the opposite direction.

```

MENU FORMAT MARKING
-> - FORMAT                               1
    - POSITION 1  ┌┐
    - POSITION 1  ┌┐┐
    - POSITION 2  ┌┐┐┐
    - POSITION 2  ┌┐┐┐┐
    - WHITE LEVEL 2
    - OUTSIDE    LIGHT
    - EXIT
  
```

```

MENU FORMAT MARKING
- FORMAT 1&2
-> - POSITION 1 ⌞
- POSITION 1 ⌞
- POSITION 2 ⌞
- POSITION 2 ⌞
- WHITE LEVEL 2
  OUTSIDE LIGHT
- EXIT
  
```

## Position - Positioning of the Format Marks

The format markings can be adapted to every different format. The format markings on the ground glass serve as a reference.

To align format 1, make sure that FORMAT 1 or FORMAT 1&2 is selected. To align format 2, make sure that FORMAT 2 or FORMAT 1&2 is selected.

To match the electronic format markings with the ground glass markings proceed as follows:

- Point the film camera towards a bright object so that the format markings on the ground glass are clearly visible.
- Move the cursor  $\rightarrow$  with the keys  $\uparrow$  and  $\downarrow$  to the line - POSITION 1  $\lrcorner$  or - POSITION 2  $\lrcorner$ , depending on whether format 1 or format 2 should get adjusted. The symbol  $\lrcorner$  indicates that the top line and the left line can be moved. To move the top line up and down, use the keys  $\uparrow$  and  $\downarrow$ , to move the left line left and right, use the keys  $\rightarrow$  and  $\leftarrow$ .
- Move the cursor  $\rightarrow$  with the keys  $\uparrow$  and  $\downarrow$  to the line - POSITION 1  $\llcorner$  or - POSITION 2  $\llcorner$ , depending on whether format 1 or format 2 should get adjusted. The symbol  $\llcorner$  indicates that the lower line and the right line can be moved. To move the lower line up and down, use the keys  $\uparrow$  and  $\downarrow$ , to move the right line left and right, use the keys  $\rightarrow$  and  $\leftarrow$ .

### White Level - Setting the Brightness of the Format Markings

The brightness of the format markings can be set to black (0), dark gray (1), and light gray (2) or white (3).

- Move the cursor  $\rightarrow$  with the keys  $\uparrow$  and  $\downarrow$  to the line – WHITE LINE. Pressing the key  $\rightarrow$  will switch the settings from 0 to 1 to 2 to 3 and back to 0, pressing the key  $\leftarrow$  will switch the settings in the opposite direction.

### Outside - Darkening the Area outside of the Format Markings



*This function is only available if one format marking is activated. No darkening function is available if there is no format marking or if two format markings are switched on.*

The brightness of the area outside of one format marking can be reduced electronically to emphasize the important image area.

- Move the cursor  $\rightarrow$  with the keys  $\uparrow$  and  $\downarrow$  to the line – OUTSIDE. Pressing the key  $\rightarrow$  will switch from no shading (VID), light shading (LIGHT), dark shading (DARK) to BLACK and back to VID. Pressing the key  $\leftarrow$  will give opposite direction.

```

MENU FORMAT MARKING

- FORMAT                               1 & 2
- POSITION 1  ┌
- POSITION 1  ┌┌
- POSITION 2  ┌┌┌
- POSITION 2  ┌┌┌┌
-> - WHITE LEVEL 2
    OUTSIDE     LIGHT

- EXIT
  
```

```

MENU FORMAT MARKING

- FORMAT                               1
- POSITION 1  ┌
- POSITION 1  ┌┌
- POSITION 2  ┌┌┌
- POSITION 2  ┌┌┌┌
-> - WHITE LEVEL 2
    OUTSIDE     LIGHT

- EXIT
  
```

```
MENU FORMAT MARKING
- FORMAT 1
- POSITION 1 ↵
- POSITION 1 ⏏
- POSITION 2 ↵
- POSITION 2 ⏏
- WHITE LEVEL 2
- OUTSIDE LIGHT
-> - EXIT
```

## Exit

Use exit to return to the main menu.

- Move the cursor ➤ with the keys ▲ and ▼ to the line  
– EXIT and press the key ▶ or ◀.

Note: Pressing the Enter/Insert key  for more than three seconds will cause the system to exit the on-screen programming mode completely, regardless of which menu is activated, with the exception of the positioning mode.

### 10.4.7 Compare/Store Menu

The IVS can store one particular image, display it or overlay it against the live image in front of the camera to compare both images.



*Changing them immediately activates all settings. Check all settings on the connected monitor.*

- Enter the Compare/Store submenu from the main menu.

#### Display mode

Display mode allows selecting whether a live image, a stored image or both images in an alternating display mode are displayed. (Please see next chapter Store Image how to store an image.)

- Move the cursor  $\rightarrow$  with the keys  $\uparrow$  and  $\downarrow$  to the line `- VIEW MODE`. Pressing the key  $\rightarrow$  will switch from LIVE to STORE to COMP and back to LIVE. The key  $\leftarrow$  will give the opposite direction.

If LIVE is selected, the actual image will be displayed. If STORE is selected, an image, which was stored before, will be displayed and if COMP is selected, a live image and a stored image will alternate to show the difference of both images.

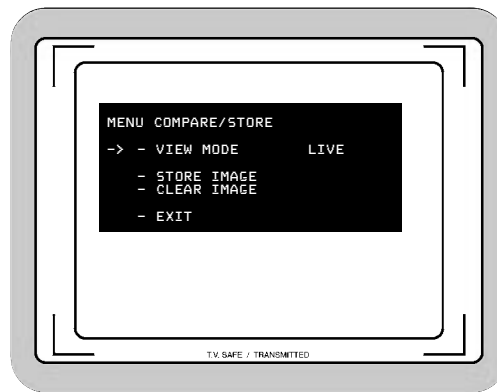

The stored image is memorized until a new image is stored or until the IVS power was shot down.





The stored image is memorized until a new image is stored, the image is cleared or until the IVS power was shot down.

```
MENU COMPARE/STORE
  - VIEW MODE          LIVE
-> - STORE IMAGE
  - CLEAR IMAGE
  - EXIT
```





```
MENU COMPARE/STORE
  - VIEW MODE          LIVE
-> - STORE IMAGE
  - CLEAR IMAGE
  - EXIT
```

### Store image

The IVS can store one particular image, display that or overlay it against the live image in front of the camera to compare both images. In parallel to pressing the Enter/Insert key  shortly (less than 1.5 seconds), the store image command in the on-screen program mode will grab one particular image, no matter of the selected display mode. (Please see previous chapter in 10.4.7 Display mode for information on different display modes, e.g. Live, Store and Compare).

- Move the cursor  with the keys  and  to the line - STORE IMAGE. Pressing the key  or  will store the image. The word **DONE** will appear for a few seconds to show that an image was stored.
- The stored image is memorized until a new image is stored, the image is cleared or until the IVS power was shot down.

### Clear image

- To clear an image, move the cursor  with the keys  and  to the line - CLEAR IMAGE. Pressing the key  or  will store the image. The word **DONE** will appear for a few seconds to show that an image was stored.



### Exit

Use exit to return to the main menu.

- Move the cursor  $\rightarrow$  with the keys  $\uparrow$  and  $\downarrow$  to the line  
– EXIT and press the key  $\rightarrow$  or  $\leftarrow$ .

Note: Pressing the Enter/Insert key  for more than three seconds will cause the system to exit the on-screen programming mode completely, regardless of which menu is activated, with the exception of the positioning mode.

```
MENU COMPARE/STORE
- VIEW MODE          LIVE
- STORE IMAGE
- CLEAR IMAGE
->- EXIT
```

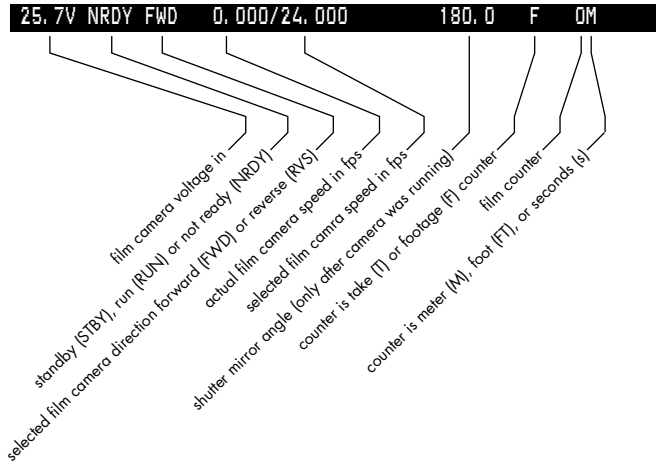
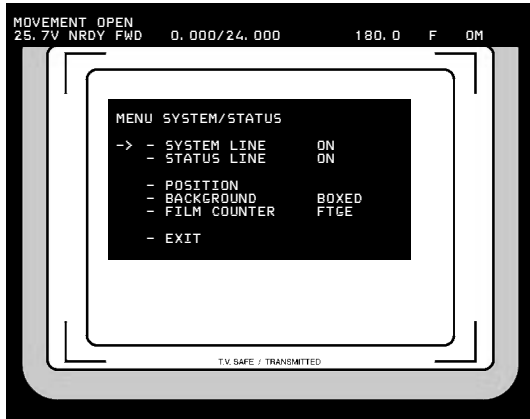

## 10.4.8 System and Status Menu

The IVS can insert the camera system and status into the video image.

The status line inserts information from the film camera such as

- movement open
- async
- inching
- low battery
- dust check
- and so on.

When the status line is switched on, an additional line will appear, similar to this:

**MOVEMENT OPEN**

Additionally, it is possible to insert camera status information in a separate line. A line similar like the one on the left will appear:

The film counter gets its data from the film camera. So the data on the IVS are identical to the data in the film camera.

If the film counter is in the take mode, the data in meter, foot or seconds of the last take are displayed. In the mode footage, the added length of the film through the camera in meter or feet is displayed.



*During programming the inserted data are not fully updated (e. g. Frame Counter Information). To get information updated, leave the on-screen display menu by pressing the Enter/Insert key  for more than three seconds.*



*After powering the film camera up, no mirror shutter angle is displayed. Data will appear only after some revolutions of the mirror shutter.*

System line and Status line are together as a package. If both lines are on, the upper line will always be status, the lower line system. Positioning always affects both lines.

Like all man readable information, the data is inserted as a window on the monitor image. The window can be switched on and off independently. Background and position can be altered without affecting the settings of other windows.

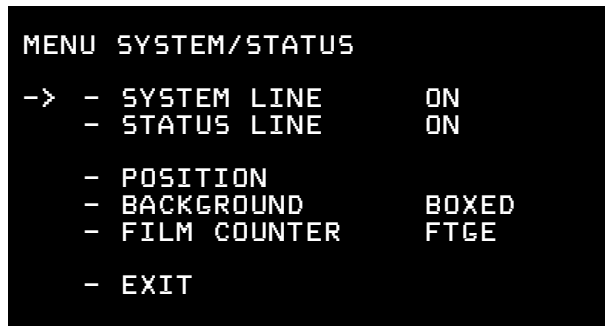

The adjustment of the white level of the inserted data, an inverse display and a fine adjustment of the vertical position is described in chapters 10.4.5 White Level, Inverse and Fine Positioning.

- Enter the System/Status submenu from the main menu.



*Changing them immediately activates all settings. Check all settings on the connected monitor.*

```
MENU SYSTEM/STATUS
-> - SYSTEM LINE      OFF
   - STATUS LINE     OFF

   POSITION
   BACKGROUND
   FILM COUNTER

   - EXIT
```

### System Line

This sub menu line switches the insertion of camera system data on (ON) and off (OFF) independently of other inserted data.

- Move the cursor > with the keys ▲ and ▼ to the line – SYSTEM LINE. The keys ► or ◀ switch the insertion on and off.

A line similar to the depicted line will appear:

```
MOVEMENT OPEN
```

Position and Background is only available if one of the two lines in on, Film Counter only if Status Line is on.

To clear this message, eliminate the cause of the problem. In this example close the movement block.

### Status Line

This submenu line switches the insertion of camera status data on (ON) and off (OFF) independently of other inserted data.

- Move the cursor  $\rightarrow$  with the keys  $\uparrow$  and  $\downarrow$  to the line - STATUS LINE. The keys  $\rightarrow$  or  $\leftarrow$  switch the insertion on and off.

A line similar to the depicted line will appear:

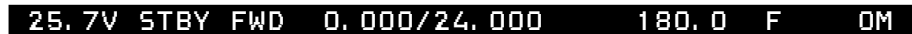
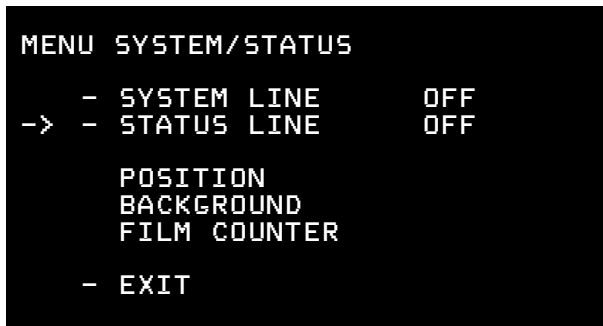

Position and Background is only available if one of the two lines in on, Film Counter only if Status Line is on.

```

MENU SYSTEM/STATUS

- SYSTEM LINE      ON
- STATUS LINE     ON

-> - POSITION
- BACKGROUND      BOXED
- FILM COUNTER    FTGE

- EXIT
    
```

```

MENU SYSTEM/STATUS

- SYSTEM LINE      ON
- STATUS LINE     ON

- POSITION
-> - BACKGROUND      BOXED
- FILM COUNTER    FTGE

- EXIT
    
```

## Position

The window can be positioned anywhere on the monitor screen. Position is only available if at least one of the two lines is on.

- Move the cursor  $\rightarrow$  with the keys  $\uparrow$  and  $\downarrow$  to the line – POSITION. Call the positioning mode with the keys  $\rightarrow$  or  $\leftarrow$ . The following menu is displayed on the screen:

```

-> - POSITION ^v E
    
```

- The keys  $\uparrow$  and  $\downarrow$  move the window up and down. When the desired position has been set, confirm by pressing the Enter/Insert key .

## Background

The background of the window can be set electronically to black in normal display mode or to white in inverse mode (BOXED) to improve the readability. If this is not activated, the area around the text is the normal video image (VIDEO).

- Move the cursor  $\rightarrow$  with the keys  $\uparrow$  and  $\downarrow$  to the line – BACKGROUND. The key  $\rightarrow$  or  $\leftarrow$  switches between BOXED and VIDEO.

## Film Counter

The film counter is slaved to the footage counter of the film camera. It always displays the values, which are in the camera. Therefore there is no set or reset of film counter data on the IVS.

- Move the cursor  $\rightarrow$  with the keys  $\uparrow$  and  $\downarrow$  to the line – FILM COUNTER. The keys  $\rightarrow$  will switch from TAKE (M/FT), TAKE (SEC) to FTGE and back to TAKE (M/FT). The key  $\leftarrow$  will give the reverse order.

Note: The dimension meter or feet is taken over from the setting of the camera. If meter are selected there, the data in the IVS are displayed in meter.

## Exit

Use exit to return to the main menu.

- Move the cursor  $\rightarrow$  with the keys  $\uparrow$  and  $\downarrow$  to the line – EXIT and press the key  $\rightarrow$  or  $\leftarrow$ .

Note: Pressing the Enter/Insert key  $\text{\textcircled{ENTER/INSERT}}$  for more than three seconds will cause the system to exit the on-screen programming mode completely, regardless of which menu is activated, with the exception of the positioning mode.

```
MENU SYSTEM/STATUS
- SYSTEM LINE      ON
- STATUS LINE      ON

- POSITION
- BACKGROUND       BOXED
-> - FILM COUNTER   TAKE
                          (SEC)

- EXIT
```

```
MENU SYSTEM/STATUS
- SYSTEM LINE      ON
- STATUS LINE      ON

- POSITION
- BACKGROUND       BOXED
-> - FILM COUNTER   FTGE

- EXIT
```

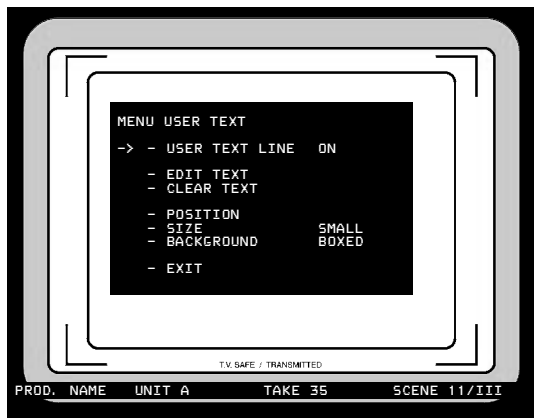

## 10.4.9 User Text Menu

The IVS can insert additional text into the video image, for example the production name or a scene number. The text can be entered on the IVS using the text edit facility.

If information is stored in the text memory, it will remain there until the memory is cleared or new information overrides the old one, even if the IVS or the camera is switched off or disconnected from the power supply. This enables for example a camera rental house to store information, which is then available to the production team. This might be for example the production name.

Like all man readable information, the data is inserted as a window on the monitor image. The window can be switched on and off independently. Background, position and character format can be altered without affecting the settings of other windows.

This additional line shows the text information, similar to this:

**PROD. NAME      UNIT A      TAKE 35      SCENE 11/III**

The adjustment of the white level of the inserted data, an inverse display and a fine adjustment of the vertical position is described in chapters 10.4.5 White Level, Inverse and Fine Positioning.



- Enter the User Text submenu from the main menu.



*Changing them immediately activates all settings.  
Check all settings on the connected monitor.*

### User Text Line

This sub menu line switches the insertion of additional text on (ON) and off (OFF) independently of other inserted data.

- Move the cursor  $\rightarrow$  with the keys  $\uparrow$  and  $\downarrow$  to the line – USER TEXT LINE. The keys  $\rightarrow$  or  $\leftarrow$  switch the insertion on and off.

The default text is all characters dotted.

### Edit Text

The text can be edited on the IVS without the need for additional devices.

- Move the cursor  $\rightarrow$  with the keys  $\uparrow$  and  $\downarrow$  to the line – EDIT TEXT. Activate the edit menu with the keys  $\rightarrow$  or  $\leftarrow$ .
- This will lead into the editing submenu.

```
MENU USER TEXT
-> - USER TEXT LINE  ON
    - EDIT TEXT
    - CLEAR TEXT

    - POSITION
    - SIZE              SMALL
    - BACKGROUND       BOXED

    - EXIT
```

```
MENU USER TEXT
    - USER TEXT LINE  ON
-> - EDIT TEXT
    - CLEAR TEXT

    - POSITION
    - SIZE              SMALL
    - BACKGROUND       BOXED

    - EXIT
```

```

MENU EDIT TEXT

(.....)
>X      <
(.....)
>      <
(.....)
>      <

MOVE THE CURSOR X <>
CHANGE CHARACTER ^v
EXIT PRESS E
    
```

```

MENU USER TEXT

- USER TEXT LINE ON
- EDIT TEXT
-> - CLEAR TEXT

- POSITION
- SIZE          SMALL
- BACKGROUND    BOXED

- EXIT
    
```

The menu EDIT TEXT is displayed on the screen:

- The X-Symbol shows, which position in the user text line is to be changed. To move this text inserter cursor X left and right, use the keys  $\blacktriangleright$  and  $\blacktriangleleft$ .
- To change the character on the position of the text inserter cursor X, use the keys  $\blacktriangleup$  and  $\blacktriangledown$ .
- After the necessary character was found, move the text inserter cursor X to the next position.
- To leave the text edit mode, press the Enter/Insert key . This will lead back to the user text menu.

### Clear Text

The user text line can be cleared on the IVS without an external device. When the text is cleared, the default line, a dotted line will appear.



*A cleared line cannot be recalled any more.*

- Move the cursor  $\blacktriangleright$  with the keys  $\blacktriangleup$  and  $\blacktriangledown$  to the line – CLEAR TEXT. Pressing the keys  $\blacktriangleright$  or  $\blacktriangleleft$  will clear the line.

## Position

The window can be positioned anywhere on the monitor screen.

- Move the cursor  $\rightarrow$  with the keys  $\uparrow$  and  $\downarrow$  to the line – POSITION. Activate the positioning mode with the keys  $\rightarrow$  or  $\leftarrow$ . The following menu is displayed on the screen:

```
-> - POSITION ^v E
```

- The keys  $\uparrow$  and  $\downarrow$  move the window up and down. When the desired position has been set, confirm by pressing the Enter/Insert key .

## Size

The size of the window can be changed independently from other inserts.

- Move the cursor  $\rightarrow$  with the keys  $\uparrow$  and  $\downarrow$  to the line – SIZE. The key  $\rightarrow$  will switch from SMALL, WIDE, HIGH to BIG and back to SMALL. The  $\leftarrow$  key will switch in opposite direction.

```
MENU USER TEXT
- USER TEXT LINE ON
- EDIT TEXT
- CLEAR TEXT
-> - POSITION          SMALL
- SIZE              BOXED
- BACKGROUND
- EXIT
```

```
MENU USER TEXT
- USER TEXT LINE ON
- EDIT TEXT
- CLEAR TEXT
-> - POSITION
- SIZE          SMALL
- BACKGROUND   BOXED
- EXIT
```

```
MENU USER TEXT
- USER TEXT LINE ON
- EDIT TEXT
- CLEAR TEXT

- POSITION
- SIZE SMALL
-> - BACKGROUND BOXED

- EXIT
```

## Background

The background of the window can be set electronically to black in normal display mode or to white in inverse mode (BOXED) to improve the readability. If this is not activated, the area around the text is the normal video image (VIDEO).

- Move the cursor  $\rightarrow$  with the keys  $\uparrow$  and  $\downarrow$  to the line - BACKGROUND. The key  $\rightarrow$  or  $\leftarrow$  switches between BOXED and VIDEO.

### Exit

Use exit to return to the main menu.

- Move the cursor  $\rightarrow$  with the keys  $\uparrow$  and  $\downarrow$  to the line  
– EXIT and press the key  $\rightarrow$  or  $\leftarrow$ .

Note: Pressing the Enter/Insert key  for more than three seconds will cause the system to exit the on-screen programming mode completely, regardless of which menu is activated, with the exception of the positioning mode.

```
MENU USER TEXT
- USER TEXT LINE ON
- EDIT TEXT
- CLEAR TEXT

- POSITION
- SIZE SMALL
- BACKGROUND BOXED
-> - EXIT
```



## 11. Accessories

### Accessory Mounting Points

On the camera body and on the electronic cover there are accessory mounting points. Various accessories can be mounted to them by using 3/8" screws.



*Check that the screws are not reaching more than 9mm into the camera body from the contact surface ⇨ **photo**, otherwise the camera can be damaged.*

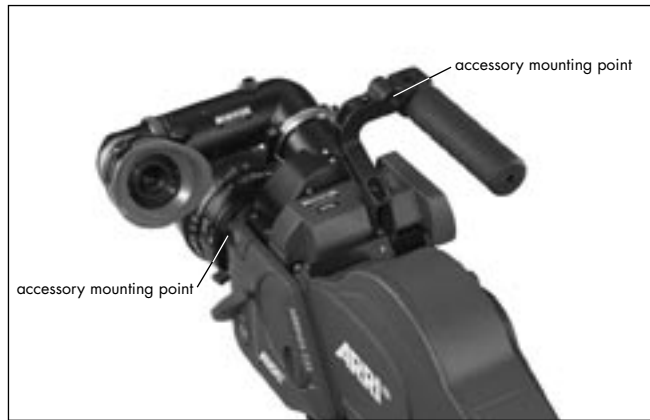
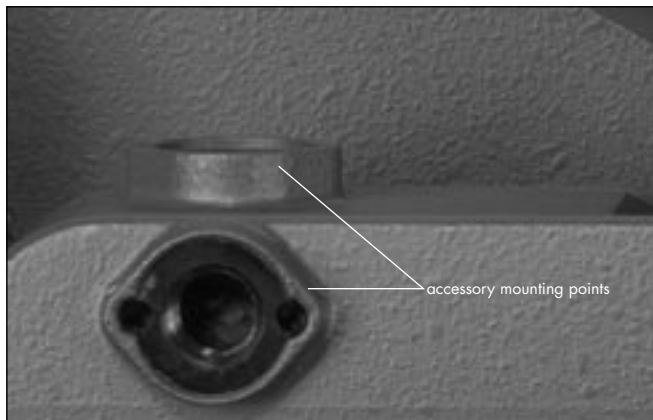
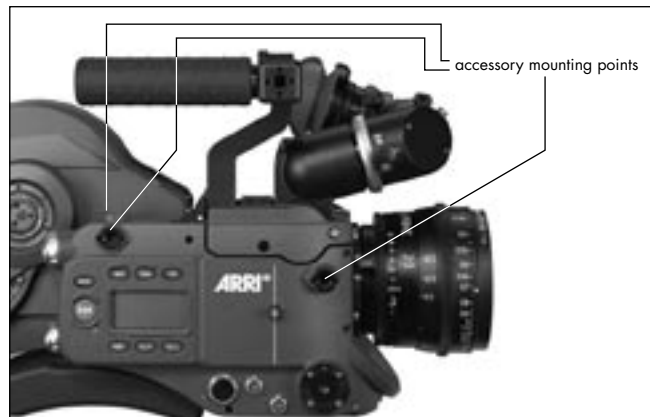



## Universal Viewfinder UV-1

When using anamorphic lenses, the UV-1 allows desqueezed viewing of the ground glass image. This viewfinder arm can also be switched over to check the anamorphically squeezed image.

- To switch over the viewfinder image, turn the switching knob ⇔ **photo**. The knob does not need to be unlocked.

All other operating elements are identical in function to those on the standard viewfinder. The anamorphic viewfinder can also be used together with the 235 finder extender.

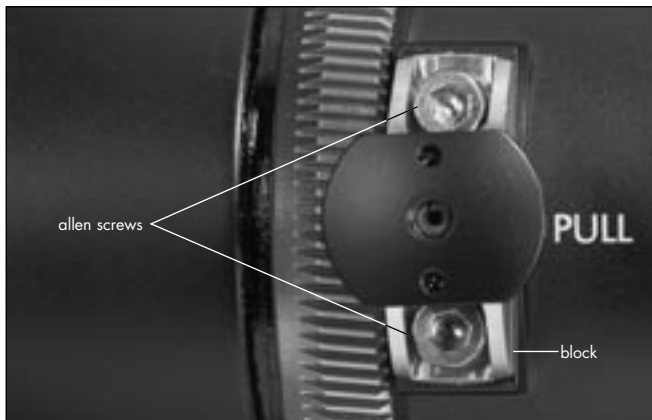

### Adjusting the UV-1

Unlike the standard viewfinder, the anamorphic viewfinder will only provide an undistorted image in horizontal, locked position. The locking stops of the UV-1 can be adjusted to an exactly horizontal position.

- Loosen (do not remove) the two allen screws ⇔ **photo** in the locking stop.
- Move the block ⇔ **photo** until the viewfinder image is free of distortion.
- Retighten the allen screws.



## Work Light WL-3

- Screw the dovetail-adapter to the handgrip.
- Slide the work light into the dovetail-guide and clamp.
- Connect the plug to the "RS"-socket.
- By adjusting the flexible arm, bring the work light into the desired position. The work light can be turned on and off with the ring on the lamp head ⇨ **photo**. The brightness of the work light can be adjusted with the mechanical aperture.



## Heated Eyecup HE-4

The heated eyecup prevents the eyepiece ⇨ **photo** from fogging in low temperatures e.g. when filming outdoors in winter.

- Pull the normal eyecup off the eyepiece, then place the heated eyecup on the eyepiece.
- Plug the heated eyecup with cable KC-42S to the RS-socket.
- Set the heating level with the toggle switch ⇨ **photo**:  
 "LO": low heat output  
 "HI": higher heat output.



*If the camera and accessories are powered by battery, it is recommended to switch off the eyecup-heating during extended breaks in filming.*



## Remote Run Switch RS-4

- Attach the remote run switch with the spring clamp  
⇒ **photo** (e.g. to the pan handle).
- Plug the RS-4 plug into the "RS"-socket.

## External Synchronization Unit ESU-1

The external synchronization unit ESU-1 ⇨ **photo** can be used with the ARRIFLEX 235 as well as with the 435 models, 535, 535B and 16SR 3/Advanced. It allows synchronization of the camera to other equipment such as TV monitors. By means of a BNC-socket, it is possible to synchronize to an external standard video signal (50/60 Hz) or, through an inductive pickup, to a computer or video monitor. The camera display shows "ESU" in the upper line. The ESU-1 can be used for frame rates from 3 to 60 fps.

The frame rate is indicated on the camera display in Mode 2. A phase shifter and a pilot tone generator have also been integrated into the external synchronization unit. The synchronization is retained even when the camera is switched off.

See TECHN. INFORMATION "External Synchronization Unit ESU-1".



- To connect the ESU cable to the camera, the 235 accessory expansion cable KC-88-s (K2.55011.0) has to be connected to the camera's remote socket. The ESU cable is then connected to the accessory expansion cable. The RCU-1 can be connected to the other socket of the accessory expansion cable.



## Remote Control Unit RCU-1

The RCU-1 ⇨ **photo** is a practical remote control unit for all new-generation ARRIFLEX cameras. It can be used in all applications that call for an uncomplicated, quick, sturdy and yet still comprehensive remote control.

Complete programs can easily be created to control changing of frame rate over a certain period of time. These programs can be recalled repeatedly as necessary.

The RCU-1 automatically calculates the actual screen-time for the programmed speed ramps. Running values can be regulated with the large handwheel.

The free programming of end stops to individually defined minimum and maximum values is particularly comfortable.

The illuminated LCD-display quickly, precisely and comprehensively shows all set values as well as the status of the camera, or the RCU-1 respectively, including all warning signals.

- The RCU cable is connected to the remote socket  
⇒ **photo** on the camera.

For further information see the RCU-1 instruction manual.

Note: The RCU-1 will always operate in the HI ramping speed. Operation in LO is not possible.



*CCU and RU are not supported and could cause malfunction when connected.*



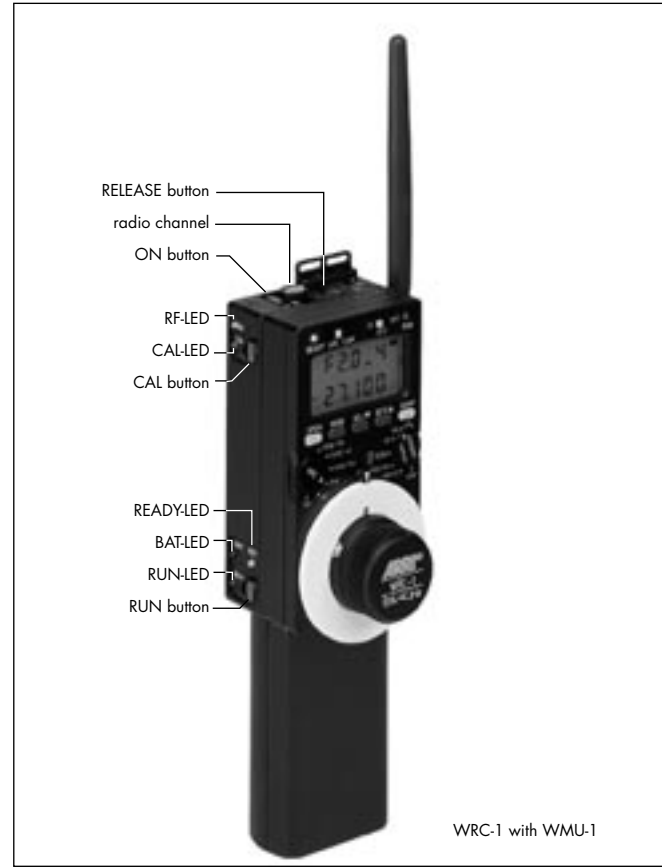
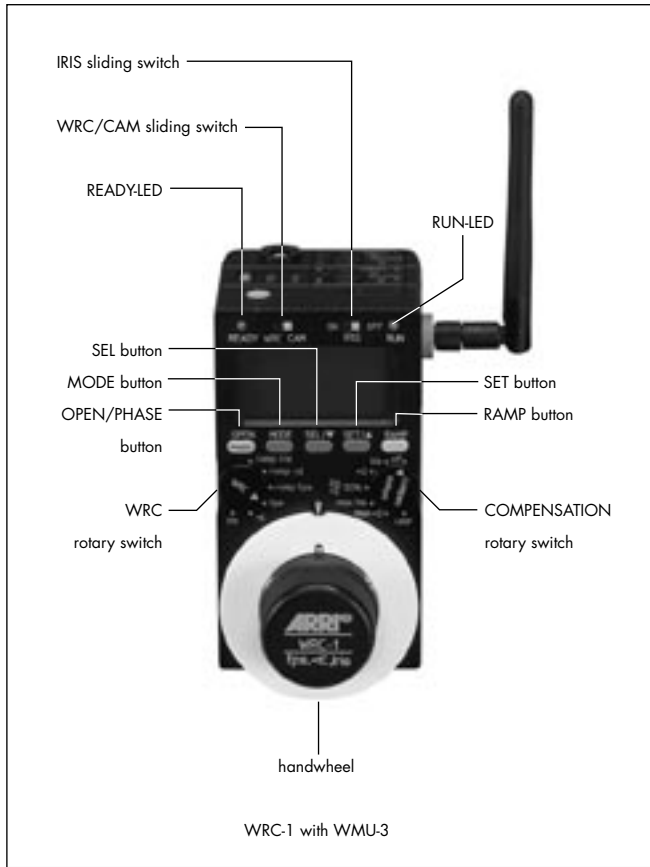

## Wireless Remote Control WRC-1

The Wireless Remote Control WRC-1 is a handy remote control unit for use with all of the latest generation of ARRIFLEX camera models: ARRIFLEX 16SR 3/Advanced, 16SR 3 HS/Advanced, 535, 535B, 435 Advanced, 435ES and the ARRIFLEX 235.

On the ARRIFLEX 235 it enables the user to remotely control:

- the camera speed,
  - the aperture of the lens (iris),
- providing compensation for constant exposure.

The range of functions offered by the WRC-1 is automatically adapted to the limits of the camera and the lens control motor to which it is connected. The large handwheel permits sensitive adjustment of operational values, and easy programming of end-stops for user-defined minimum and maximum values.

The illuminated LCD provides quick, precise and comprehensive information about all the settings, the status of the camera and the WRC-1, including all warnings.

The WRC-1 is the perfect addition to the ARRI Wireless Lens Control System. Connected to the Wireless Main Unit of the Wireless LCS it enables all functions to be remotely controlled. The WRC-1 can also be connected to the camera via cable using the Wireless Handgrip Attachment WHA-1 of the Wireless LCS system. However, the lens remote-control functions are not available in this mode.

Note: The WRC-1 will always operate in the HI ramping speed. Operation in LO is not possible.





## 12. Super 35

When delivered, the camera is set to Super 35. The Super 35 format offers a range of technical advantages compared to filming with anamorphic lenses:

- a larger selection of available focal lengths,
- smaller and lighter-weight lenses,
- faster lenses,
- shorter lens focus for close-up shots,
- clearly reduced image distortion and geometric aberrations.

In addition, a greater variety of post-production possibilities is available.

For shooting in Normal 35, the lens mount receptacle and the upper plate of the bridge plate must be altered for the format. This ensures that the lenses and accessories are exactly aligned to the optical center of Normal 35.

### Converting the Lens Mount Receptacle to Normal 35

For shooting in Normal 35, the lens mount receptacle must be turned 180°.

- Remove the six cylindrical screws ⇨ **photo**.
- Unscrew both locking grips ⇨ **photo**.

- Turn the lens mount receptacle so that the number "1" is positioned next to the marking ⇨ **photo**.
- Unscrew the index pin ⇨ **photo** and screw into the opposite inner thread.
- Screw both locking grips firmly into the correct operating position ⇨ **photo**.
- Replace the six cylindrical screws and screw tight.
- Check the flange focal distance.

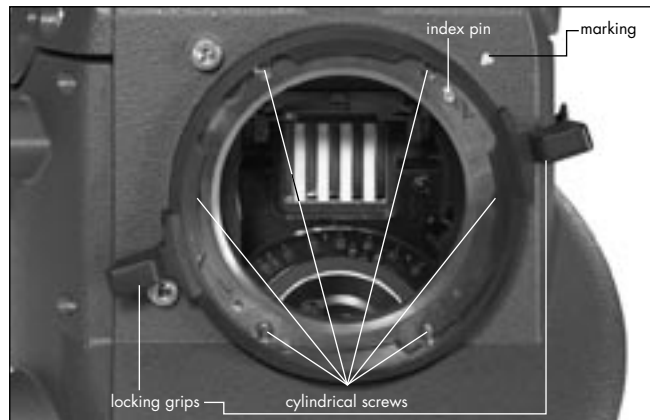

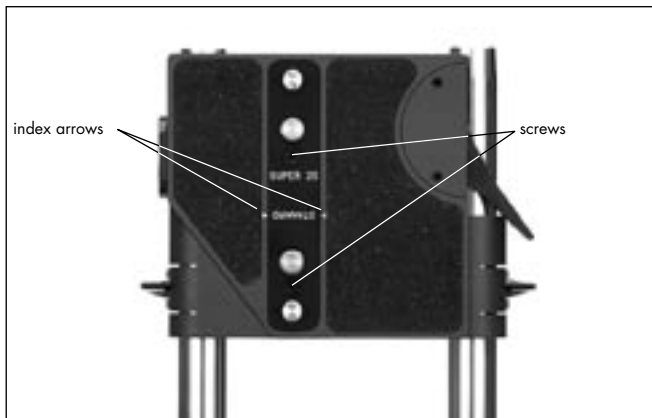

## Converting the Bridge Plate to Super 35

The current position, standard or Super 35, is displayed by two index arrows on the sliding upper plate. The bridge plate can be converted to Super 35 as follows:

- Remove the two screws ⇨ **photo**.
- Turn the compensation bar 180° and screw tightly in this position.

Note: The viewfinder system is so designed that no alteration is necessary for shooting in Super 35.

## 13. Maintenance

When maintaining and cleaning the camera and accessories, pay careful attention to the following notes and tips:

- Always disconnect the camera from the power supply.
- Clean the camera and accessories only on a clean and flat surface which is covered with foam material or a clean, lint-free cloth.
- Under no circumstances use acetone or nitro-thinner. These chemicals dissolve the paint and can damage highly-polished surfaces.
- For cleaning, it is recommended to use soft, lint-free cloths and swabs. Also suitable are special cleaning tissues and small sponges as used in cleaning computers and video equipment.
- When cleaning the film movement, do not exert too much pressure. Use only the prescribed special tools. Use only screwdrivers of the correct size.
- From time to time – at the latest however after the occurrence of a film jam – it is recommended to clean the entire interior of the camera and also the magazine throat, the film movement and the film gate with a brush. In most cases it is sufficient to vacuum out dust and film chips from the camera and the magazine interiors. A small battery-powered vacuum cleaner, as used in cleaning computers, is suitable for this task.

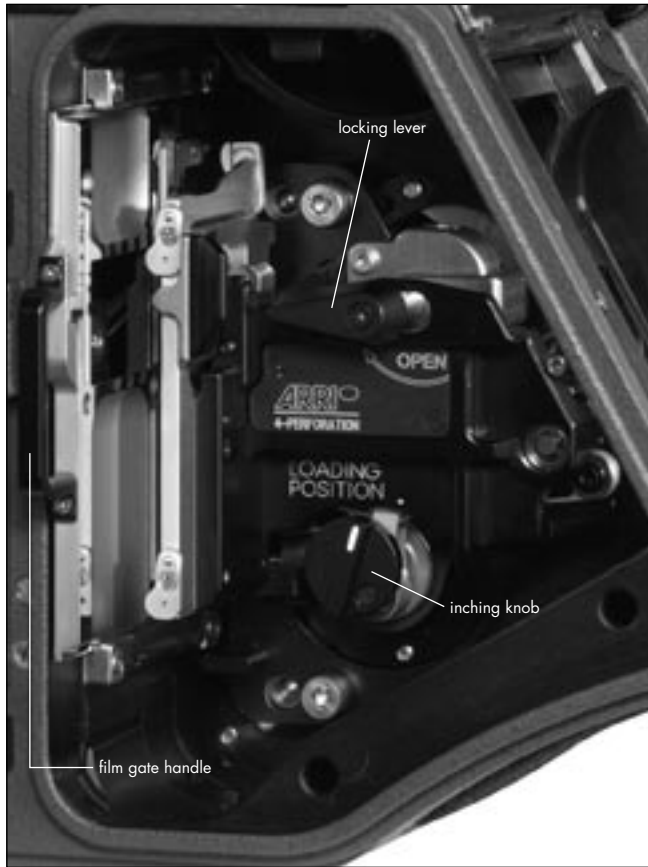

## Camera

### Cleaning the Film Gate

Loose dust or dirt leads to a layer of emulsion forming on the film gate. This can cause scratches on the film and can also lead to a change in the film's coefficient of friction. The film gate must be removed for cleaning.



*Attention!*

*Keep fingers out of the film gate opening as this may dirty or damage the mirror shutter.*

#### To remove the film gate

- Switch off the camera's main switch and disconnect the camera from the power supply before removing the film gate.
- Turn the inching knob ⇨ **photo** on the movement until its marking matches that on the movement block.
- Turn the movement locking lever ⇨ **photo** towards the "OPEN" position to swing the movement block away from the film gate.
- Pull the film gate out of the camera using the film gate handle ⇨ **photo**.

## To clean the film gate

- Remove the layer of emulsion from the film gate with a plastic rod (e.g. an ARRI film gate cleaner). Under no circumstances use hard or metal objects.
- When cleaning, pay particular attention to the area opposite the film guides of the movement if film stock with a strong tendency to build up emulsion (e.g. b/w stock) is being used.
- Check that the hole for the registration pin is empty.

## Inserting the film gate



*Warning: It is absolutely essential to ensure that the connecting surfaces are free of dust and debris (e.g. film chips) in order to guarantee the accuracy of the film channel.*

- Check that the film gate and the film gate guide rails are completely free of dust and dirt.
- Take hold of the film gate by the film gate handle and push it back into place.
- Check that the film gate is pushed all the way back.



*Swinging the movement block forwards when the film gate is not correctly in place can cause damage to the camera!*

- Close the movement again. The movement holds the filmgate in place.

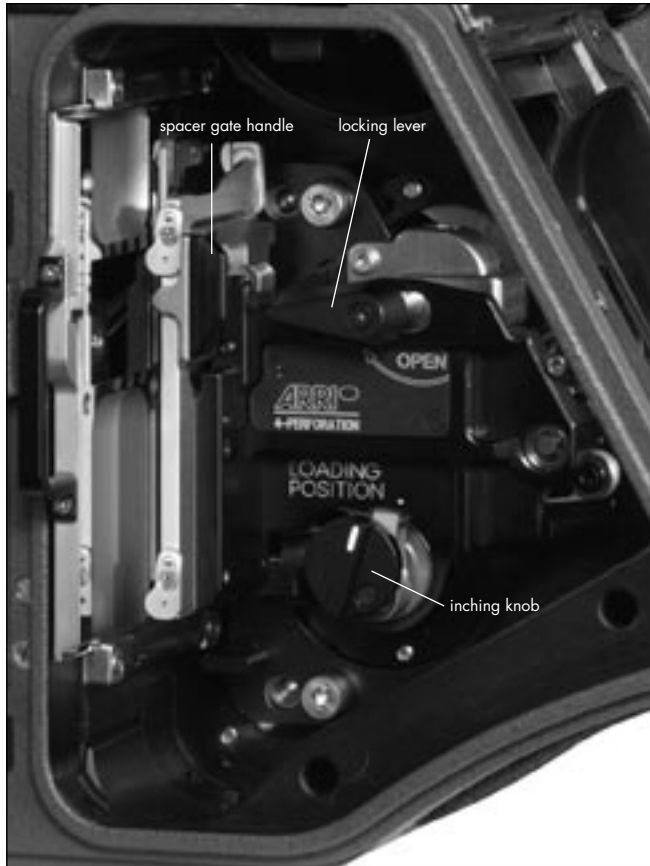

## Cleaning the Spacer Gate

Loose dust leads to a build-up of emulsion on the spacer gate. This can cause scratches on the film and a change in the coefficient of friction.

- Switch the camera's main switch off and disconnect the camera from the power supply!
- Turn the inching knob until its marking matches that on the movement block.
- Turn the locking lever towards the "OPEN"-position to swing the movement block away from the film gate.
- Press the spacer gate backwards by its handle ⇨ **photo**. Then remove by pulling upwards.
- Remove the layer of emulsion from the spacer gate ⇨ **photo** with a plastic rod (e.g. an ARRI film gate cleaner). Under no circumstances use hard or metal objects.
- When cleaning, pay particular attention to the spacer gate if film stock with a strong tendency to build up emulsion (e.g. b/w stock) is being used.
- Take hold of the spacer gate by its handle ⇨ **photo** and insert it at an angle from above into the movement block.
- Push the spacer gate downwards until it locks audibly in place.
- Close the movement again.

## Cleaning the Field Lens

- By briefly depressing the "PHASE"-button, the shutter is positioned to protect the mirror surface from damage as far as possible.
- Before cleaning the field lens, switch the camera's main switch off and disconnect the camera from the power supply!
- Remove the lens or the protective cap.
- Using the special forceps, push the field lens as far as it will go into the holder. A ball catch fixes the field lens in the correct position.
- Check if the ground glass to be used and the ground glass frame are completely clean.
- Using the special forceps, push the ground glass into the holder as far as it will go. A ball catch fixes the ground glass in the correct position.
- Check that the ground glass is locked in place.



*Do not touch the mirror surface!*

- Pull the ground glass ⇔ **photo** out of the holder by its tongue ⇔ **photo** using the special forceps.
- Using the special forceps, first lift the field lens ⇔ **photo** upwards by its tongue ⇔ **photo** then pull it out of its holder.
- Clean the field lens with a dry, lint-free cloth.
- Make sure that the frame is completely clean.

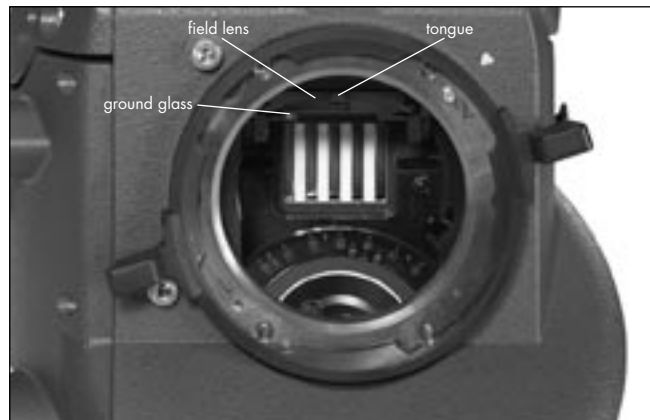

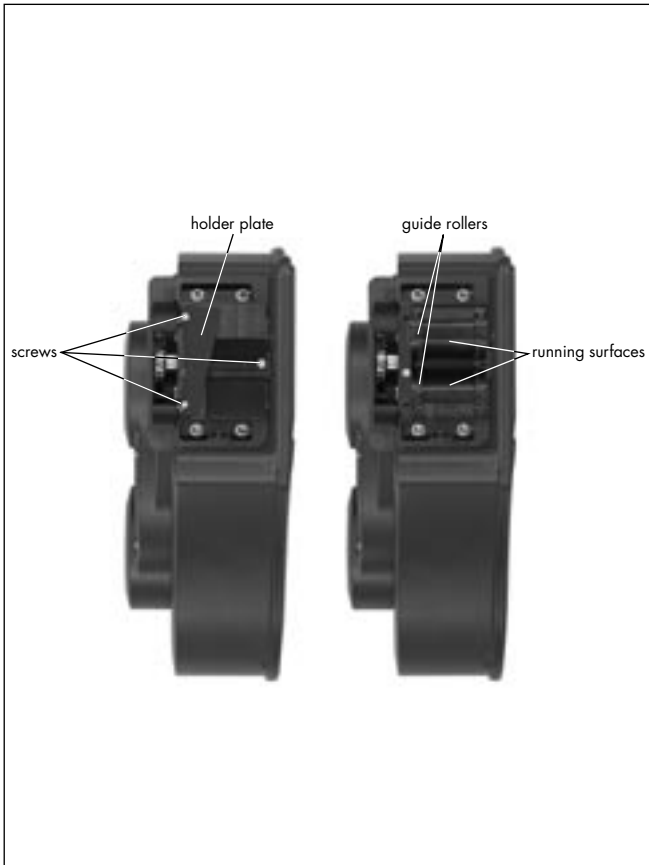

## Magazine

### Cleaning the Throat Assembly

The throat assembly ⇨ **photo** can be disassembled for cleaning.

- Loosen the three screws ⇨ **photo** on the throat assembly cover ⇨ **photo**.
- Remove the holder plate ⇨ **photo** for the loop protector.
- Pull out the throat assembly cover.
- Clean the film running surfaces ⇨ **photo** and guide rollers ⇨ **photo** with a brush.
- Put the throat assembly cover back in place.
- Replace the holder plate for the loop protector and re-tighten the throat assembly cover with the three screws.

### Setting Friction on the Shoulder Magazine

- Swing the roller arm ⇨ **photo** away from the winding shaft until it locks in place.
- Unscrew the three screws on the transparent tensioning plate ⇨ **photo**.
- Remove the plate.
- Place a film core on the take-up side.
- Place the core adapter ⇨ **photo** on the feed-side.
- Place the tension measurement device ⇨ **photo** on the core adapter on the feed side.



- Hang the hook of the measurement device ⇨ **photo** on the film core which is to be measured.
- Attach the open magazine to the camera.



*Do not place your hand in the running magazine!*

- To set the take-up shaft, run the camera at 24 fps. The tension measurement device should be showing ring "5".
- If the tension measurement device is not showing "5", stop the camera.
- Switch off the camera's main switch and disconnect the camera from the power supply.
- Place the special key ⇨ **photo** in the holes of the friction adjustment and turn in steps. The adjustment must lock in at each step. When setting friction, the corresponding winding shaft must be held firmly.
- Turn clockwise to increase friction, counter-clockwise to decrease friction.
- Connect the camera to the power supply and switch on.
- Run the camera at 24 fps.
- Check the tension.

Note: Repeat this procedure until ring "5" is shown.

- After setting the friction, replace the tensioning plate.
- Fasten the plate with the three screws.

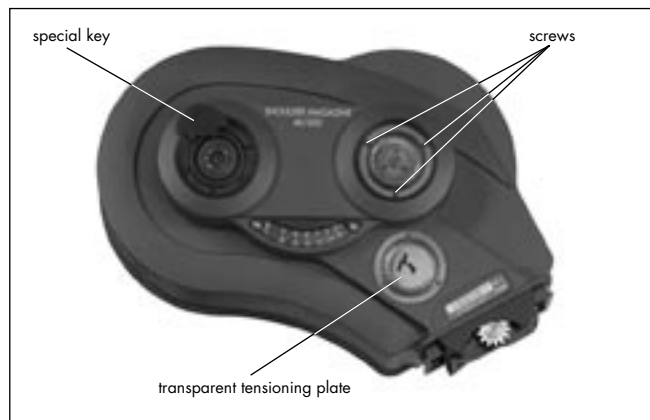
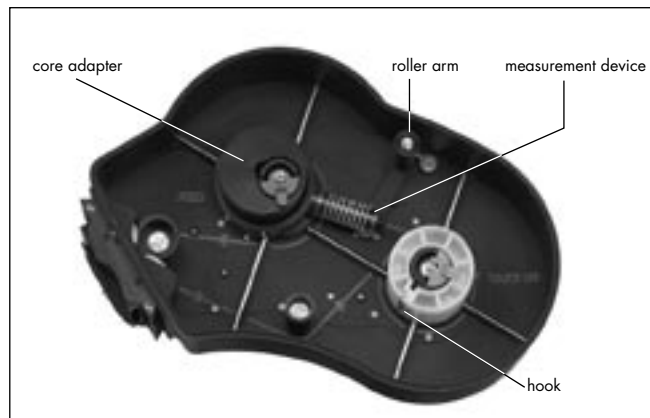



## 14. Appendix

The frame rate of the camera is constantly monitored while it is running. If the actual frame rate deviates from the set frame rate, the operation control indicator glows red and the camera display shows the warning for asynchronous running ("asy").

### Loose Film Loops in the Magazine

If the camera shuts off automatically while running, loose film loops may be formed in the magazine. Before the camera is started again, the film in the magazine must be tensioned manually.

### Fuses

The ARRIFLEX 235 is equipped with self-resetting automatic fuses. It is therefore not necessary to replace blown fuses.

Error text in display	Error text in IVS	Problem
trAnS oPEn	movement open	movement open
bound F-len	maximum takelength exceeded	As no 1000ft magazines are allowed, the camera switches off after 420ft
Error Hot	motor excess temperature	maximum motor temperature has been exceeded, wait until motor has cooled down
Error CntL	Controller Error	internal controller limits have been exceeded, check if camera is jammed
Updt	software update in progress	camera software and firmware is updated
Async	camera speed is not the choosen speed	
inching	camera is inching	
low battery	camera supply voltage too low, change battery	

Problem	Cause	Remedy
<b>Scratches on the emulsion side of the negative</b>		
In the image area, over several frames	Dirty or damaged cross bars on the film gate	Clean or, if defective, replace the film gate
In the image area, short and periodically recurring (above and below)	Upper or lower film loop too long, film touches inside of camera housing	Check the position of the upper loop in relation to the marking Check the loop length of the magazine
Outside the image area	Dirty or damaged longitudinal bars on the film gate or film running surfaces in the magazine throat	Carefully clean film gate and magazine throat or, if defective, replace
<b>Scratches on the glossy side of the negative</b>		
In the image area	Dirty or damaged film track or spacer gate	Clean film track (movement) and spacer gate or, if defective, replace
Outside the image area	Dirty or damaged longitudinal bars on the film track or film running surfaces in the magazine throat	Carefully clean longitudinal bars and magazine throat or, if defective, replace
Scratching in general	Strong tendency of raw film stock to build up emulsion, dust on raw stock from perforation process, extreme temperatures, scratched raw stock	Complain to the manufacturer of the film stock, use different film stock

Problem	Cause	Remedy
<p><b>Unsteady Image</b></p> <p>Vertical</p>	<p>Heavy emulsion build-up in the film gate area, damaged film perforation, very poor gliding ability of the raw film stock, film stock with positive perforation, dimensions of raw stock not within tolerance</p>	<p>Clean film gate area, use different film stock</p>
<p>Horizontal</p>	<p>Heavy emulsion build-up in the film gate area, film edge is not straight</p>	<p>Clean film gate area, use different film stock</p>
<p>Pressure exposures around perforation holes</p>	<p>Mechanical stress on the perforation holes</p>	<p>Pressure exposures do not effect the image steadiness</p>
<p><b>Image Problems</b></p> <p>Blurred image</p>	<p>Flange focal distance is incorrectly set, lens is incorrectly set, poor quality or defective lens, film gate is not properly locked into position</p>	<p>When cleaning or exchanging the film gate ensure that the surfaces are absolutely clean, check the lens and the flange focal distance</p>





## Erklärung über die Konformität

Diese Erklärung gilt für folgend bezeichnete Erzeugnisse:

**Geräteart:** Kamera  
**Typenbezeichnung:** ARRIFLEX 235

Hiermit wird bestätigt, daß die Produkte den wesentlichen Schutzanforderungen entsprechen, die in den Richtlinien des Rates zur Angleichung der Rechtsvorschriften der Mitgliedstaaten über die elektromagnetische Verträglichkeit 89/336/EWG und der Niederspannungsrichtlinie 73/23/EWG festgelegt sind.

Diese Erklärung wird abgegeben durch:

**ARNOLD & RICHTER**  
**CINE TECHNIK GmbH & Co. Betriebs KG**  
 Türkenstrasse 89  
 80799 München  
 Germany

Die jeweiligen Prüfungen wurden bei akkreditierten Prüflabors durchgeführt.

Zur Beurteilung der Erzeugnisse hinsichtlich elektromagnetischer Verträglichkeit sowie der Niederspannungsrichtlinie wurden folgende Normen herangezogen:

DIN EN 55103-1: 1997-06

DIN EN 55103-2: 1997-06

(DIN EN 61000-4-2: 2001-12, DIN EN 61000-4-3: 2001-12,  
 DIN EN 61000-4-4: 2002-07, DIN EN 61000-4-5: 2001-12,  
 DIN EN 61000-4-6: 2001-12, DIN EN 61000-4-11: 2001-12)

DIN EN 61000-3-2: 2001-12  
 DIN EN 61000-3-3: 2002-05

DIN EN 60065: 2003-01

28.4.2004  
 Datum / Ort

  
 rechtsgültige Unterschrift des Inverkehrbringers



# 15. Technical Data

## Film Format

35mm (DIN 15501)

## Magazines

235 Shoulder Magazine 60/200 (SHM-1)..... forward only, up to 60 fps

235 Shoulder Magazine 120/400 (SHM-2)..... forward only, up to 60 fps

235 Steadicam Magazine 120/400 (STM-1) ..... forward up to 60 fps reverse 25 fps

All ARRIFLEX 35 III and 35 II 60m/200ft and 120m/400ft magazines  
with exception of the shoulder magazine;

All ARRIFLEX 435 120m/400ft magazines

## Lens Mount

54mm PL-mount (positive locking)

Convertible for Super 35

## Flange Focal Distance

51.98-0.01mm

## Mirror Shutter

Manually adjustable from 45° to 180°.

## Movement

5-link movement  
with single-pin registration  
and single two-pin pull-down claw  
for 35mm negative film (DIN 15501);  
equipped with ball bearings for low maintenance.

## Speed Range

1-60 fps forwards and 25 fps reverse (quartz stabilized)  
adjustable to 0.001 fps

## Viewfinder

Adjustable in two axes with automatic image compensation  
and additional manual image compensation.

## Ground Glasses

Interchangeable for various filming formats, same ground glasses as Arriflex 435

## Operating Temperature Range

-20°C to +50°C (-4°F to +122°F)

## Power Supply

24 V DC

Acceptable voltage range: ..... 20.6...35 V DC

## Function Monitoring

Power supply voltage (BAT)

Synchronous running (ASY)

## IVS

Weight .....approx. 0.35 kg

power consumption .....approx. 5.4 W

Inputs ..... –

Outputs: ..... 2 outputs for composite video or alternatively

1 output for composite video

1 Mini-Monitor output

Optic .....covers silent format

Optic Alignment:..... X, Y rotation and focus

## Dimensions

Length with Shoulder Magazine 60/200 without lens:.... 450mm .....(17 <sup>6</sup>/<sub>8</sub>"

Width with viewfinder on the left: ..... 230mm (without handgrip) .....(9 "

250mm (with handgrip) .....(9 <sup>7</sup>/<sub>8</sub>"

with viewfinder on the right:..... 270mm .....(10 <sup>5</sup>/<sub>8</sub>"

Height with grip:..... 240mm .....(9 <sup>4</sup>/<sub>8</sub>"

without grip: ..... 214mm .....(8 <sup>3</sup>/<sub>8</sub>"

## Weight

ARRIFLEX 235 without magazine, without lens

including spherical viewfinder, IVS and Standard Handgrip: 4.1 kg ... (9,03 lbs)

# 16. Order Numbers

ARRIFLEX 235 Body 4 perforation .....	K1.55000.0	Support rods 240mm, ø 19mm .....	K2.43046.0
ARRIFLEX 235 Body 3 perforation .....	K1.55000.3	Support rods 240mm, ø 15mm .....	K2.21958.0
ARRIFLEX 235 Spherical Viewfinder set.....	K2.55009.0	Support rods 340mm, ø 19mm .....	K2.47347.0
ARRIFLEX 235 Universal Viewfinder set.....	K2.55010.0	Support rods 340mm, ø 15mm .....	K2.47348.0

## Installation of the Camera

ARRIHEAD 2.....	K2.43670.0	235 Standard Camera Handle.....	K2.55004.0
ARRIHEAD 2 with Encoders .....	K2.52090.0	235 Low Mode Handle.....	K2.55006.0
Hydrohead Studio 80 II M .....	K2.45348.0	Handle Extension Block.....	K4.65107.0
Hydrohead 150 H.....	K2.50491.0	235 Low Mode Support.....	K2.55014.0
		235 Side bracket .....	K2.55015.0

Wedge plate.....	K2.47092.0		
Lens support LS-7, ø 19mm.....	K2.42538.0		
Lens support LS-8, ø 15mm.....	K2.49012.0		

Shoulder pad.....	K2.55005.0		
-------------------	------------	--	--

Camera Handgrip, Right with On/Off Switch.....	K2.45886.0		
--	------------	--	--

Riser plate .....	K2.55002.0		
Bridge plate BP-8, ø 19mm .....	K2.47090.0		
Bridge plate BP-9, ø 15mm .....	K2.47091.0		

## Power Supply

235 On Board Battery (OBB-1) .....	K2.47553.0
235 On Board Battery Charger.....	K2.47554.0
235 On Board Battery Cable .....	K2.47555.0

Battery NC 24/7 R.....	K2.41950.0
Battery cable KC 20S .....	K2.41966.0
Charger NCL 24 R .....	K2.42010.0

Mains unit NG 12/24 R .....	K2.44481.A
Mains unit NG 12/26 (4-pin) .....	K2.47352.0
Mains unit NG 12/26 (5-pin) .....	K2.47351.0
Spiral battery cable KC 29S.....	K2.44693.0

## Magazines

235 Shoulder Magazine 60/200 (SHM-1).....	K2.55001.0
235 Shoulder Magazine 120/400 (SHM-2).....	K2.55016.0
235 Steadicam Magazine 120/400 (STM-1) .....	K2.55008.0
Tool set for adjusting magazine friction .....	K2.26100.0
Adaptor for use of K2.26100.0 in the 60m Magazine .....	K5.65443.0

## Optical Accessories

Lightweight Follow Focus Set for 19mm (LFF-1/19) .....	K0.60021.0
3" x 3" light-weight matte box LMB-2 .....	*K0.59954.0
4" x 4" light-weight matte box LMB-3 .....	*K2.44471.0
4"x5,65" light-weight matte box LMB-5 .....	K2.47239.0
4" x 4" production matte box MB-16 .....	*K2.44472.0
4" x 5.65" production matte box MB-18 .....	*K2.47178.0
4" x 5.65" production matte box MB-19 .....	*K2.47099.0
5" x 6" production matte box MB-15 .....	*K2.44473.0
6.6" x 6.6" production matte box MB-14 .....	*K0.59971.0
Heated eyecup HE-4.....	K2.47527.0
Cable KC-42 (for RS socket).....	K4.47473.0
Medium Eyepiece Extension .....	K2.55000.0
Long Eyepiece Extension .....	K2.55012.0

\* These order numbers refer to matte boxes for ø 19mm support rods

## Accessories

External synchronization unit ESU-1 .....	K2.46006.0
Remote switch RS-4 .....	K2.46942.0
Remote control unit RCU-1 .....	K2.47197.0
Work light WL-3 .....	K2.47098.0

## Videassist

235 Integrated Videassist PAL.....	K2.47524.0
235 Integrated Videassist NTSC .....	K2.47525.0

# 17. ARRI Service

**Germany** ..... Arnold & Richter  
Cine Technik  
Türkenstraße 89  
D-80799 München  
phone: +49 (089) 3809-0  
fax: +49 (089) 3809-1244  
E-mail: webmaster@arri.de

**USA** ..... ARRI Inc.  
(East Coast)  
617, Route 303  
Blauvelt, New York 10913  
phone: (914) 353 14 00  
fax: (914) 425 12 50  
E-mail: arriflex@arri.com

(West Coast)  
600 North Victory Blvd.  
Burbank, California 91502  
phone: (818) 841 70 70  
fax: (818) 848 40 28  
E-mail: arriflex@arri.com

**GB** ..... ARRI (GB) Ltd.  
2 Highbridge  
Oxford Road  
Uxbridge  
Middlesex, UB8 1LX  
phone: (0) 1895 457 000  
fax: (0) 1895 457 001  
E-mail: sales@arri-gb.com

**Italy** ..... ARRI ITALIA S.r.l.  
Viale Edison 318  
20099 Sesto S. Giovanni (Milano)  
phone: (02) 26 22 71 75  
fax: (02) 242 16 92  
E-mail: info@arri.it

Via Placanica, 97  
00040 Morena (Roma)  
phone: (06) 79 89 02 1  
fax: (06) 79 89 02 206

**Canada** ..... ARRI Canada Ltd.  
415 Horner Avenue, Unit 11  
Etobicoke, Ontario  
Canada M8W 4W3  
phone: (416) 255 33 35  
fax: (416) 255 33 99  
E-mail: service@arri-can.com



## 18. Index

- A**
- accessories ..... 135
    - 24 V ..... 28
    - external synchronization unit ESU-1 ..... 139
    - heated eyecup HE-4 ..... 137
    - remote control unit RCU-1 ..... 140
    - remote run switch RS-4 ..... 138
    - universal viewfinder UV-1 ..... 136
    - work light WL-3 ..... 137
  - accessory mounting points ..... 135
  - accessory power supply ..... 28
  - accessory socket
    - RS-socket ..... 28
  - acoustic warning
    - setting warning signals ..... 64
  - adapter BNC to Y/C ..... 75
  - alignment ..... 81
    - focus ..... 81
    - image rotation ..... 81
    - screws ..... 81
    - X-alignment ..... 81
    - Y-alignment ..... 81
  - all standard ..... 100
  - appendix ..... 155
  - ARRIMAG 120 ..... 29, 161, 164
  - ARRIMAG 120S ..... 29
  - ARRIMAG 300E ..... 29, 161, 164
  - automatic
    - gain control ..... 86
    - white balance ..... 82
  - AWB ..... 82
- B**
- balancing the camera ..... 17
  - battery cable KC 20S ..... 26, 27
  - battery NC 24/7 R ..... 26
  - beamsplitter ..... 48
  - Black and White Output ..... 76
  - BNC Connectors Output ..... 110
  - BP-8 ..... 16
  - BP-9 ..... 16
  - bridge plate
    - attaching to camera ..... 17
    - BP-8, BP-9 ..... 16
    - converting to Super 35 ..... 146
  - buttons
    - MODE ..... 55
    - PHASE ..... 55, 59, 62
    - PROG ..... 55
    - RUN ..... 53, 56
    - SEL ..... 55
    - SET ..... 55

- C**
- cable
    - cabling the IVS..... 72
    - KC-42S ..... 137
    - KC 20S ..... 26, 27
    - KC 29S ..... 26, 27
  - camera
    - camera body ..... 37
    - installation ..... 15
    - main switch ..... 53
    - operation..... 53
    - starting..... 53
    - stopping ..... 54
  - changing bag ..... 30
  - changing settings with the IVS
    - blue ..... 82, 85, 104
    - format marking number ..... 91
    - green ..... 82
    - red..... 82, 84, 103
  - charger NCL 24 R..... 26
  - check menu IVS..... 79
  - CID-discharge lamps ..... 39
  - clear
    - image ..... 120
    - text..... 130
  - compare..... 119
  - compare/store menu ..... 119
    - clear image ..... 120
    - display mode..... 119
    - exit ..... 121
    - store image..... 120
  - composite video outputs..... 73
  - continuous current..... 28
  - cover
    - for magazine opening ..... 35
- D**
- darkening the outside area ..... 117
  - darkroom ..... 30
  - daylight mode at IVS ..... 82
  - dimensions ..... 162
  - diopter adjustment..... 49
  - display
    - display lock ..... 55
    - display movement open ..... 57
    - film counter..... 58
    - Mode 1 ..... 55, 56, 58, 59, 60
    - Mode 2 ..... 56, 61
    - Mode 3 ..... 56, 58, 59, 63
    - Mode 4 ..... 56, 64
    - Mode 5 ..... 56
    - Mode 6 ..... 56
    - Mode 7 ..... 56



- overview of display modes ..... 56
  - shutter angle ..... 59
  - take length ..... 58
  - total amount of exposed film ..... 58
  - display mode at IVS ..... 119
  - dovetail-adapter ..... 137
- E**
- edit text ..... 129
  - emulsion build-up
    - film gate ..... 148
    - spacer gate ..... 150
  - enter/insert ..... 97
  - ESU-1 ..... 139
  - exit ..... 101, 107, 113, 118, 121, 127, 133
  - external standard video signal ..... 139
  - external synchronization unit ESU-1 ..... 139
  - eyecup ..... 137
  - eyepiece ..... 48
    - adjusting friction ..... 49
    - adjusting the diopter ..... 49
    - attaching ..... 48
    - removing ..... 48
- F**
- field lens, cleaning ..... 151
  - film
    - changing bag ..... 30
    - loading the shoulder magazine ..... 30
  - film counter ..... 58, 127
    - changing unit of measurement (meters/feet) ..... 59
    - configuring ..... 59
    - displaying film counting values ..... 58
    - resetting ..... 59
  - film cutting gauge ..... 30
  - film format ..... 161
  - film gate
    - cleaning ..... 148
  - film gate cleaner ..... 149, 150
  - fine-tuning the programmed frame rate ..... 62
  - fine adjustment vertical position ..... 112
  - flange focal distance ..... 161
  - flicker free on/off ..... 89, 108
  - focus adjustment IVS ..... 81
  - format marking ..... 95
  - format marking menu ..... 114
    - activate ..... 115
    - brightness ..... 117
    - darkening the outside area ..... 117
    - exit ..... 118
    - positioning ..... 116
    - white level ..... 117

- forward operation ..... 61
- frame rate
- changing while camera is running ..... 61
  - fine-tuning ..... 62
  - freely programmed frame rate ..... 61
  - setting and storing ..... 60
  - shifting phase ..... 62
  - standard frame rate ..... 60
- frame store and compare ..... 119
- friction
- eyepiece ..... 49
  - viewfinder arm ..... 49
- friction of ARRIMAG 120, adjusting ..... 152
- function monitoring ..... 162
- fuses ..... 155
- G**
- gain control ..... 86
- automatic ..... 86
  - manual ..... 86
- general description ..... 13, 67
- grip system ..... 20
- ground glasses ..... 162
- exchanging ..... 40
  - frame ..... 40
  - special forceps ..... 40
- H**
- HE-4 ..... 137
- heated eyecup HE-4 ..... 137
- helicopter mount ..... 15
- hide menu ..... 79, 80
- HI / LO ramps with RCU-1 ..... 141
- HI / LO ramps with WRC-1 ..... 141
- HI / LO ramps with WRCU-1 ..... 143
- HMI/CID-discharge lamps ..... 39
- HMI light ..... 39
- I**
- image
- position IVS ..... 81
  - rotation adjustment IVS ..... 81
- image compensation ..... 50
- automatic ..... 50
  - inverting the image ..... 51
  - manual ..... 50
  - reactivating automatic image compensation ..... 51
- image position
- inverting the viewfinder image ..... 51
- inching ..... 55
- IND ..... 82
- indoor mode at IVS ..... 82
- inserter ..... 97
- inserter facilities ..... 95

- installation ..... 15
    - IVS..... 70
  - inverse ..... 112
  - iris
    - IVS..... 80
  - IVS
    - off..... 79
    - on..... 79
    - setup..... 70
- L**
- length unit (meters/feet), changing ..... 59
  - lenses ..... 47
    - attaching ..... 47
    - lens support LS-7..... 19
    - lens support LS-8..... 19
    - support..... 19
  - lens mount ..... 47, 161
  - lens mount, converting to Super 35..... 145
  - lens support ring ..... 19
  - LFF-1 ..... 23
  - lightweight follow focus..... 23
  - line interpolation on/off..... 109
  - LMS-1 ..... 22
  - load/store menu ..... 98
    - all standard ..... 100
    - exit ..... 101
    - load settings ..... 99
    - store settings ..... 99
  - load settings ..... 99
  - LOCK button ..... 55
  - loop protector ..... 15, 30, 35
  - loose film loops in the magazine ..... 155
  - low mode bracket..... 22
  - low mode handle ..... 21, 22
  - low mode riser..... 22
  - low mode support ..... 22
  - low sensitivity film..... 80
- M**
- magazine ..... 29, 161
    - ARRIFLEX 35 III magazines..... 29
    - ARRIFLEX 435 magazines ..... 29
    - ARRIMAG 120 ..... 29, 161, 164
    - ARRIMAG 120S..... 29
    - ARRIMAG 300E..... 29, 161, 164
  - film tension, measuring ..... 152
  - friction of ARRIMAG 120, adjusting ..... 152
  - loading ..... 30
  - loose film loops ..... 155
  - magazine throat, cleaning ..... 152
  - removing ..... 45
  - removing exposed film..... 34
  - roller arm ..... 31
  - safety catch..... 30
  - tensioning plates ..... 33
  - transport and storage ..... 35
  - magazine throat, cleaning ..... 152

- main
    - features IVS ..... 67
    - menu IVS..... 97
  - mains unit NG 12/24 R ..... 27
  - mains unit NG 12/26 R ..... 27
  - maintenance ..... 147
  - MAN ..... 82
  - manual
    - gain control ..... 86
    - gain control on/off..... 105
    - gain increase/decrease ..... 106
    - white balance blue ..... 104
    - white balance red ..... 103
  - man readable information ..... 95
  - mechanical iris IVS..... 80
  - mini monitor output ..... 78, 111
  - mirror shutter
    - displaying shutter angle ..... 59
    - mechanically adjustable..... 37
    - setting the mirror shutter angle ..... 37
  - Mode-button ..... 55
  - Mode 1 ..... 55, 56, 58, 59, 60
  - Mode 2 ..... 56, 61
  - Mode 3 ..... 56, 58, 59, 63
  - Mode 4 ..... 56, 64
  - Mode 5 ..... 56, 65
  - Mode 6 ..... 56
  - Mode 7 ..... 56
  - movement..... 41
    - display movement open ..... 57
    - technical data ..... 161
- N**
- NORM-button ..... 61
  - NORM-setting..... 60
  - normal video ..... 73, 75, 76, 77, 78, 110
- 
- on-screen
    - displays..... 95
    - program menu ..... 97
  - operational parameters
    - displaying and setting..... 55
  - optics ..... 47
  - order numbers ..... 163
  - OTD..... 82
  - outdoor ..... 82
  - outputs ..... 72
    - black and white ..... 76
    - composite ..... 73
    - general..... 72
    - mini monitor ..... 78
    - Y/C ..... 74
  - overload display ..... 28

- P**
- packing and transport ..... 15
  - peak load, current ..... 28
  - PHASE-button ..... 55, 59, 62
  - phase shifting ..... 62
  - pickup ..... 139
  - pilotone generator ..... 139
  - PL-mount ..... 161
  - power supply ..... 25, 162
  - power supply for accessories ..... 28
  - power supply voltage display ..... 63
  - programmed frame rate, setting ..... 61
  - PS-Mode ..... 62
  - PS/CCU-button ..... 61
  - PS/CCU-position ..... 60
- Q**
- quartz-synchronized monitors ..... 62
- R**
- RCU-1 ..... 140
    - HI / LO ramps ..... 141
  - remote control unit RCU-1 ..... 140
  - remote run switch RS-4 ..... 138
  - reverse operation ..... 61
  - RS-4 ..... 138
  - RUN-button ..... 54, 56
- S**
- safety specifications ..... 7
  - SBR-1 ..... 23
  - screen-time for speed ramps ..... 140
  - SEL-button ..... 55
  - settings ..... 98
  - setup IVS ..... 70
  - shifting phase ..... 62
  - shoulder cushion ..... 24
  - shoulder magazine
    - loading ..... 30
  - shoulder magazine, ARRIFLEX 35 III ..... 161
  - shoulder operation ..... 24
  - shutter angle display ..... 59
  - shutter angle for HMI/CID light ..... 39
  - side bracket ..... 23
  - spacer gate
    - cleaning ..... 150
    - installing ..... 41
    - removing ..... 41
  - special forceps for ground glass ..... 40, 151
  - speed range ..... 161
  - spiral battery cable KC 29S ..... 26, 27
  - standard camera handle ..... 20
  - standard frame rates ..... 60
    - selecting ..... 60

- standard video controls..... 79  
   automatic gain control..... 86  
   changing format marking number ..... 91  
   flicker free on/off..... 89  
   focus ..... 81  
   gain control ..... 86  
   iris ..... 80  
   on/off and check/hide menu ..... 79  
   storing a video image..... 93  
   white balance ..... 82  
   X-, Y- and rotation adjustment ..... 81  
 standard video signal, external ..... 139  
 starting..... 53  
 status line ..... 122, 125  
 stopping ..... 54  
 store..... 119  
   image ..... 93, 120  
   settings ..... 99  
 Super 35..... 145  
   converting bridge plate..... 146  
   converting lens mount..... 145  
 support ring..... 19  
 support rods ..... 17  
   15 mm ..... 16  
   19 mm ..... 16  
 symbols, meaning of the ..... 9  
 synchronization of camera to other equipment..... 139  
 system/status menu ..... 122  
   background ..... 126  
   exit ..... 127  
   film counter..... 127  
   position ..... 126  
   status line ..... 125  
   system line..... 124  
 system line..... 122, 124
- T**
- take length..... 58  
 technical data ..... 161  
 temperature range..... 162  
 tension measurement device..... 152  
 time code  
   warning signal, switching on and off ..... 64  
 total amount of exposed film ..... 58  
 tripod  
   removing the camera from the tripod ..... 18  
   tripod heads ..... 15  
 tungsten lighting..... 82
- U**
- unit of measurement (meters/feet)  
   changing on film counter ..... 59

universal viewfinder UV-1 .....	136	line interpolation on/off.....	109
user text menu.....	128	mini monitor output .....	111
background .....	132	vertical position.....	112
clear text .....	130	white level .....	111
edit text .....	129	Y/C normal video .....	110
exit .....	133	Y/C video with data.....	110
position .....	131	viewfinder arm	
size .....	131	extending .....	50
user text fine .....	129	setting friction .....	49
UV-1 universal viewfinder .....	136	swivelling .....	49
<b>V</b>		turning the eyepiece .....	49
VBS.....	73	viewfinder friction.....	49
vertical position.....	112	viewfinder system .....	48, 161
fine adjustment.....	112	adjusting .....	49
video		attaching .....	51
Standard Controls .....	79	removing .....	51
With Data.....	73, 75, 76, 77, 78, 110	voltage range .....	25, 162
video-assist-system .....	67	<b>W</b>	
video/text adjustment		warning displays.....	57
menu.....	108	warning signal	
video/text adjust menu		settings .....	64
BNC connectors output .....	110	switching on and off.....	64
exit .....	113	volume .....	64
flicker free on/off.....	108	WB/gain menu.....	102
invers .....	112	weight.....	162

white balance ..... 82, 102  
  AWB ..... 82  
  changing blue ..... 82, 85  
  changing green ..... 82  
  changing red ..... 82, 84  
  IND ..... 82  
  MAN ..... 82  
  OTD ..... 82  
white balance/gain menu ..... 102  
  exit ..... 107  
  manual gain control on/off ..... 105  
  manual gain increase/decrease ..... 106  
  manual white balance blue ..... 104  
  manual white balance red ..... 103  
  white balance ..... 102  
white level ..... 111  
wireless remote control ..... 143  
WL-3 ..... 137  
work light WL-3 ..... 137  
WRC-1 ..... 143  
  HI / LO ramps ..... 141, 143

**X**

X-adjustment ..... 81

**Y**

Y-adjustment ..... 81

**Y/C**

  normal video ..... 75, 110

  output ..... 74

  video with data ..... 75, 110



# IVS Quick Reference

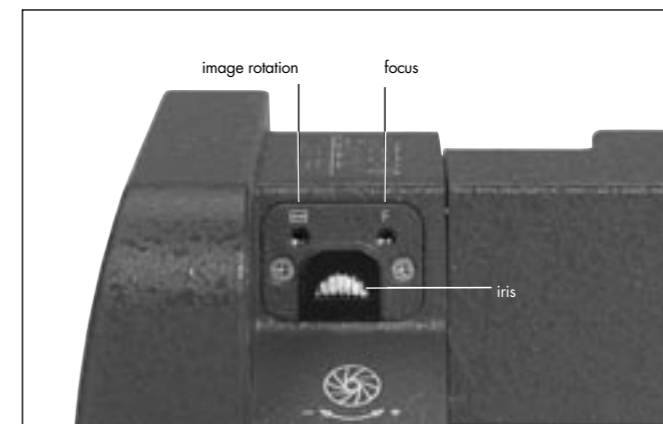
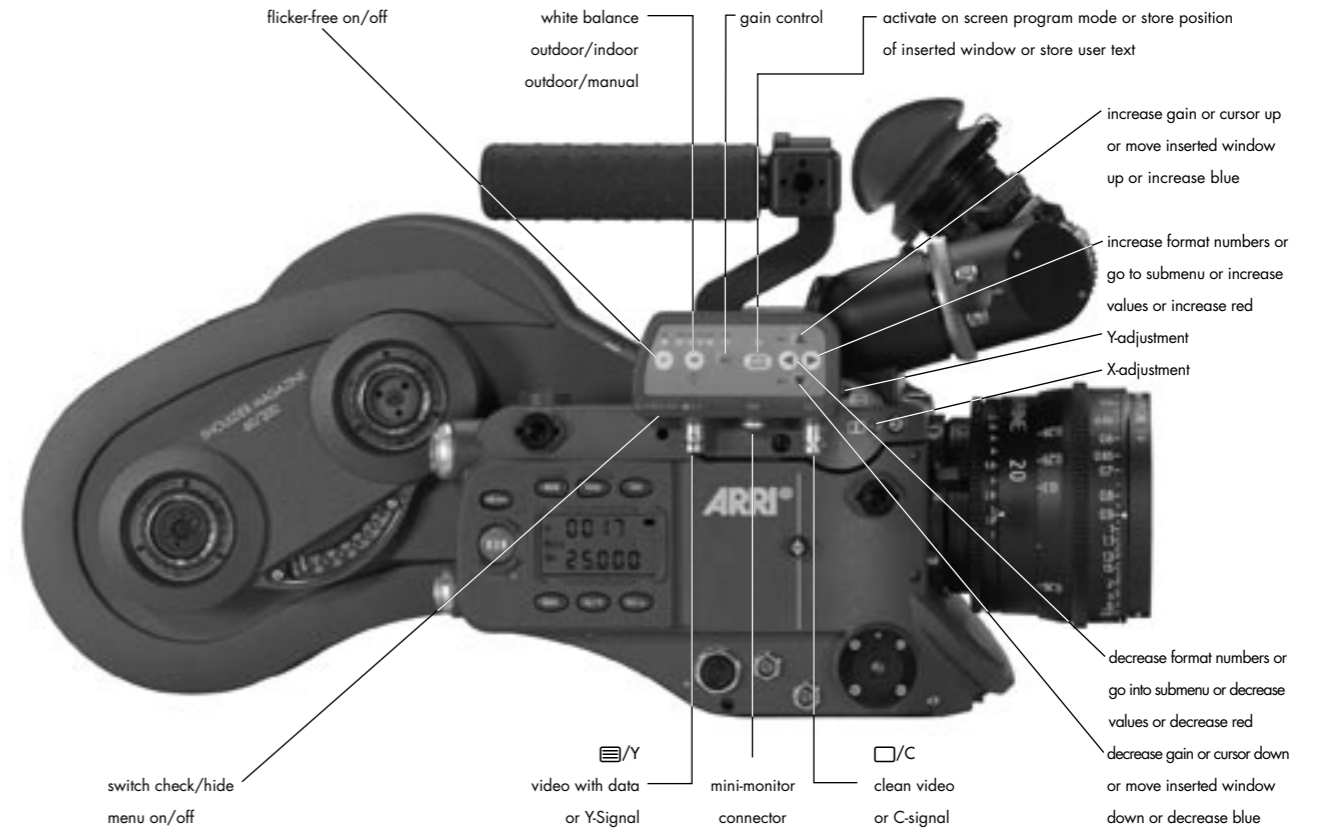
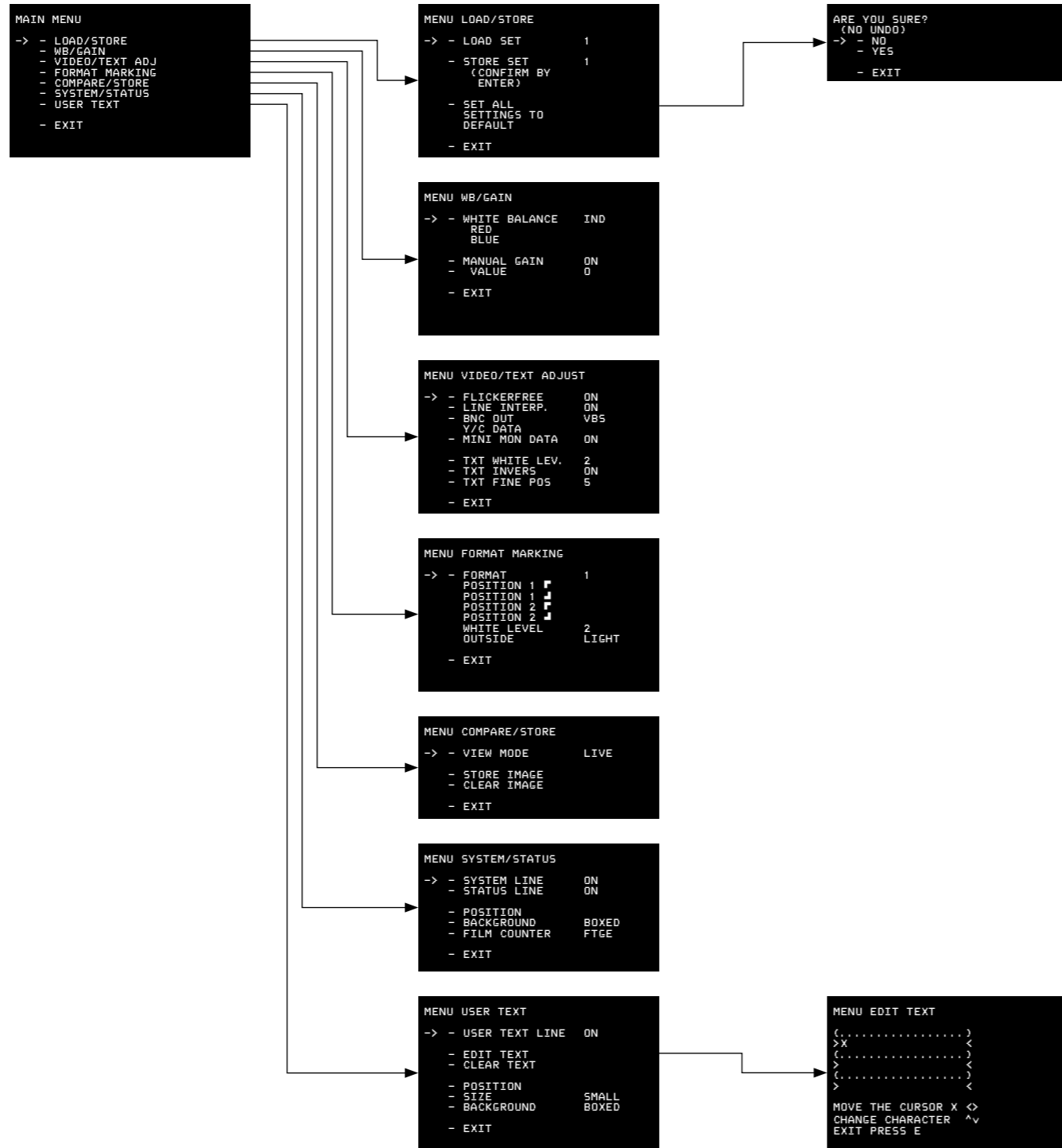

technical data are subject to change without notice

© ARRI 2005

JThieser@arri.de

Ident-No. K5.65348.0

available languages:

English



ARNOLD & RICHTER CINE TECHNIK

Türkenstr. 89 • D-80799 München

Phone +49 – 089 – 38 09 – 0 • Fax +49 – 089 – 38 09 – 1 2 4 4

[www.arri.com](http://www.arri.com)