

EIGER 500

DOUBLE & SINGLE WIDTH SQ AGR

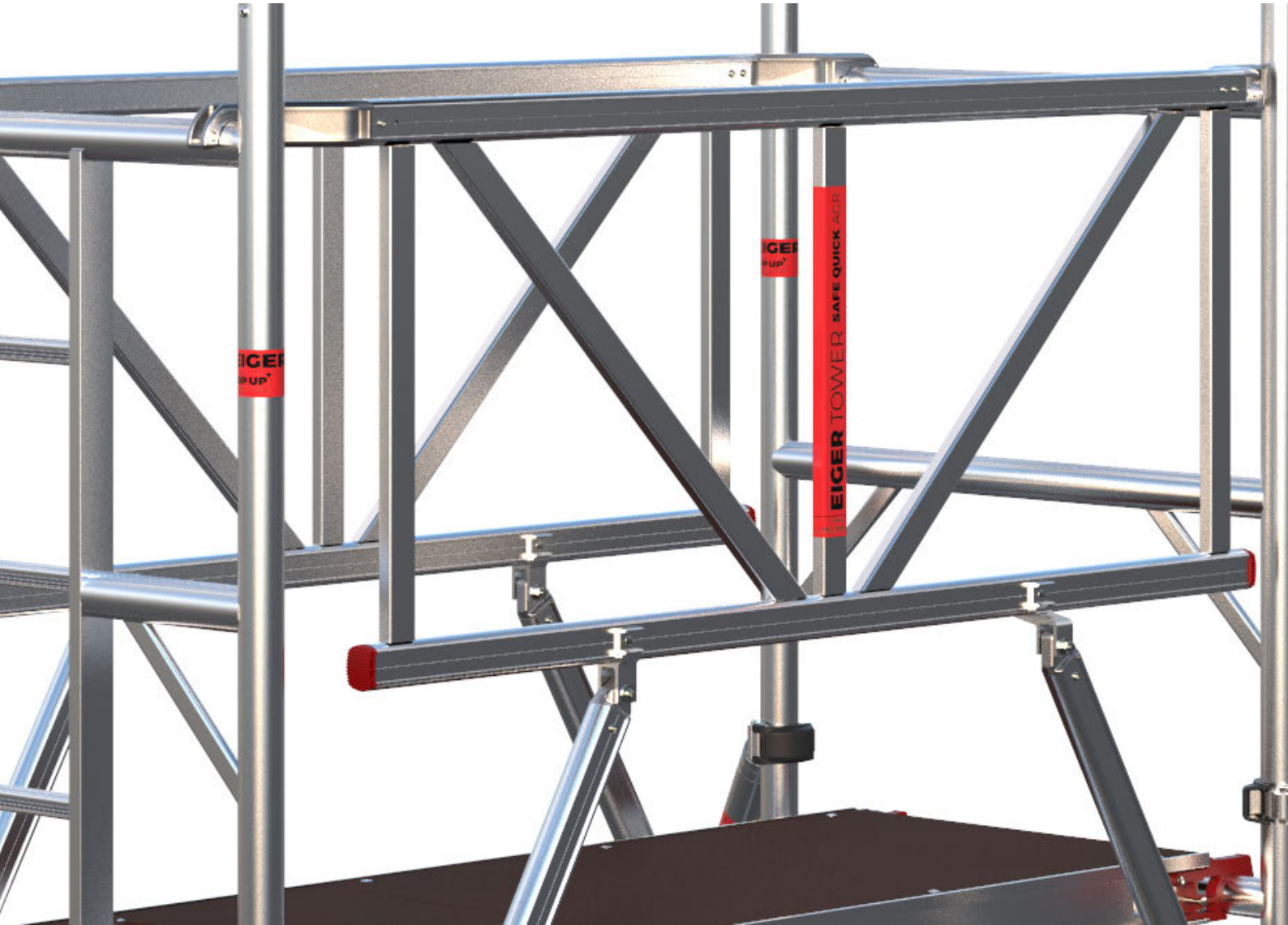

INSTRUCTION MANUAL EN 1004-2-en
(Rev.04 21-09-2023)



+44 (0)1244 833 933



info@popupproducts.co.uk



popupproducts.co.uk



INSTRUCTION MANUAL

FOR EIGER 500 DOUBLE & SINGLE WIDTH AGR

CONTENTS

CONTENTS	1	EIGER 500 4.2M DW - ASSEMBLY	12
INTRODUCTION	2	EIGER 500 3.7M SW - ASSEMBLY	13
KNOW YOUR EIGERTOWER	3	10 POINT PRE-USE SAFETY CHECKLIST	14
KNOW YOUR EIGERTOWER'S COMPONENTS	4	REGISTRATIONS	15
KNOW YOUR KIT LIST AND SPECIFICATIONS	6		
SAFETY DOS AND DON'TS - ALWAYS	8		
SAFETY DOS AND DON'TS - NEVER	9		
BEFORE YOU START	10		
GETTING STARTED	11		

INTRODUCTION

EIGERTOWER is a versatile and high quality mobile access tower providing one work platform for one person used throughout the building and construction industry for both indoor and outdoor access solutions, where a stable and secure platform is required. Ideal for maintenance and installation work or short term access. It is designed in accordance with the latest testing and quality standards. EIGERTOWER complies with BS EN 1004 -1 : 2020 and WAHR with vertical ladder access and designed for Class 3 loadings. Platform heights between 2.2m & 12.2m internal / external. Tower designation is EN1004-3-2/12-XXXD-H2.

This instruction manual is in compliance with BS EN 1004-2-en.

Verification and assessment documentation is held by POP UP Products Ltd.

Our priority is to help ensure the safe operation of our products, so please pay particular attention to the safety tips on pages 8 & 9.

We want you to enjoy the safe and responsible use of EIGERTOWER with the minimum of fuss and this guide is designed to get you up and running as quickly and as safely as possible.

We recommend that you read this guide prior to assembling and using your EIGERTOWER.

This instruction manual shall be available on the location of use of your EIGERTOWER.

Your EIGERTOWER shall only be used in accordance with this assembly guide without modification and national regulations.

User training courses cannot be a substitute for instruction manuals but only complement them.

This product shall only be used according to the instruction manual.

Only original Pop Up Products EIGERTOWER components, in undamaged condition as specified in this instruction manual, shall be used to assemble this access tower.

Pop Up Products Limited cannot accept responsibility in the event of an accident occurring because of mixing components from different manufacturers.

Mobile access and working towers designed in accordance with EN 1004-1 are not anchor points for personal fall arrest equipment.

Working is only permitted on a platform with complete side protection, including guardrails and toeboards.

Maximum uniformly distributed load permitted on a single platform is 275Kg, ensuring the hatch area is always kept clear of materials to allow unimpeded access to the platform.

Visit PASMA and HSE for further reference.

KNOW YOUR EIGERTOWER

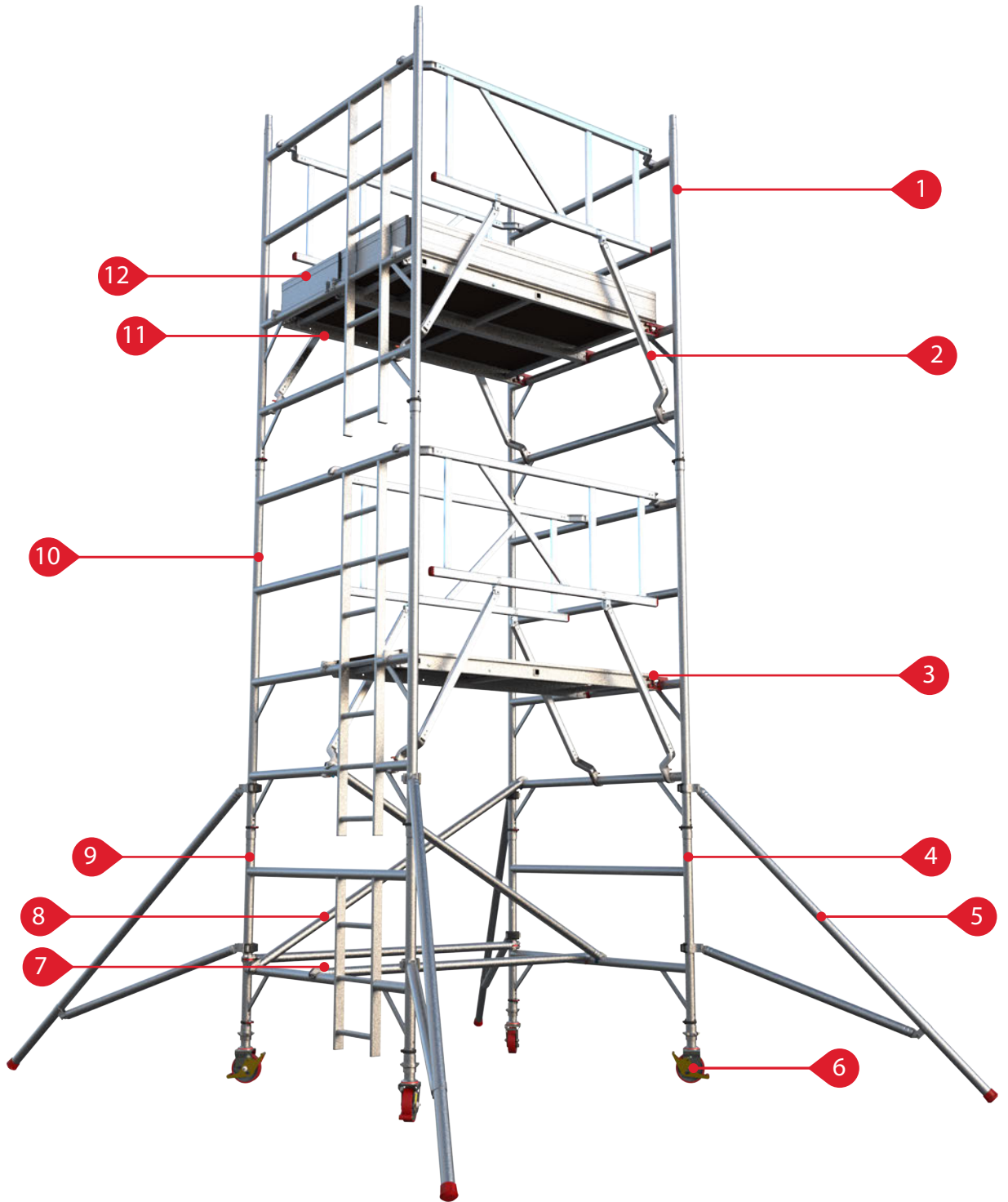

PARTS LISTING

1	4 RUNG FRAME	7	HORIZONTAL BRACE
2	SQ AGR PANEL	8	DIAGONAL BRACE
3	HATCH PLATFORM	9	2 RUNG LADDER FRAME
4	2 RUNG FRAME	10	4 RUNG LADDER FRAME
5	STABILISER	11	STANDARD PLATFORM
6	ADJUSTABLE LEG & CASTOR	12	TOEBOARD

KNOW YOUR EIGERTOWER COMPONENTS

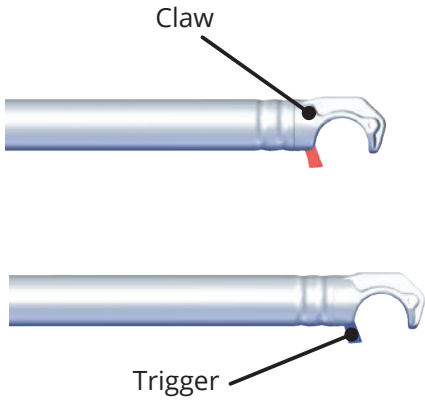

1 BRACES

Both horizontal and diagonal braces are fitted with triggered hooks at both ends. The triggers, when operated, pull back to allow the hook to be placed over the tubing used on the tower. Horizontal braces are also used as guardrails. All brace hooks (Except the first base assembly braces) must be attached to the top of the frame horizontal tube. Always double check that each hook is positively locked onto the tubing before using the tower. The brace hook trigger mechanisms are colour coded to show which are the horizontal (Red) and which are the diagonal (Blue) braces.

2 FRAME CLIPS

The frame clip's pin locates into a retaining hole in the frames to lock tower sections together when placed one on top of the other. The pin is locked in place by a red tab to ensure that it remains in place. From the disengaged position, pivot the pin / tab to bring the pin horizontal. Insert the pin fully through the retaining hole with its tail pointing down. Next flip the tab vertically to lock the pin in place. Removal is simply a reversal of the fitting sequence.

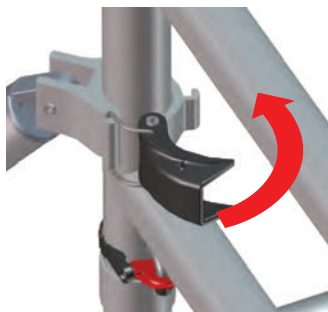
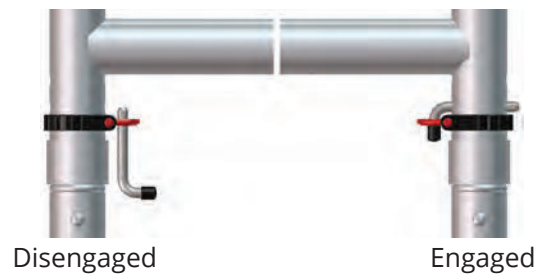

3 STABILISER COUPLER CLAMP

The coupler clamps are used to secure the stabilisers to the tower's vertical tubing. With the clamp jaw open, offer it to the tube. Bring the jaw around the tube and set the buckle on to the hook, then close the clamp arm to lock the stabiliser in position. A similar clamp is fitted to the stabiliser extension leg.

4 WIND-LOCK CATCH

The wind lock catches comprise of a set of auto-engaging hooks at one end of the platform and a single gravity type catch at the other. The purpose of these devices is to prevent up-lift of the platforms in windy conditions. To engage the auto wind lock (AWL) simply tilt the platform at the angle shown before placing the hooks onto the rung of the end frame. Lower the opposite end of the platform onto the opposite end frame rung and the gravity type lock will automatically engage. Simply lift and hold the gravity lock before tilting the platform to dis-engage the opposite AWL hooks when removing the platform on tower disassembly.

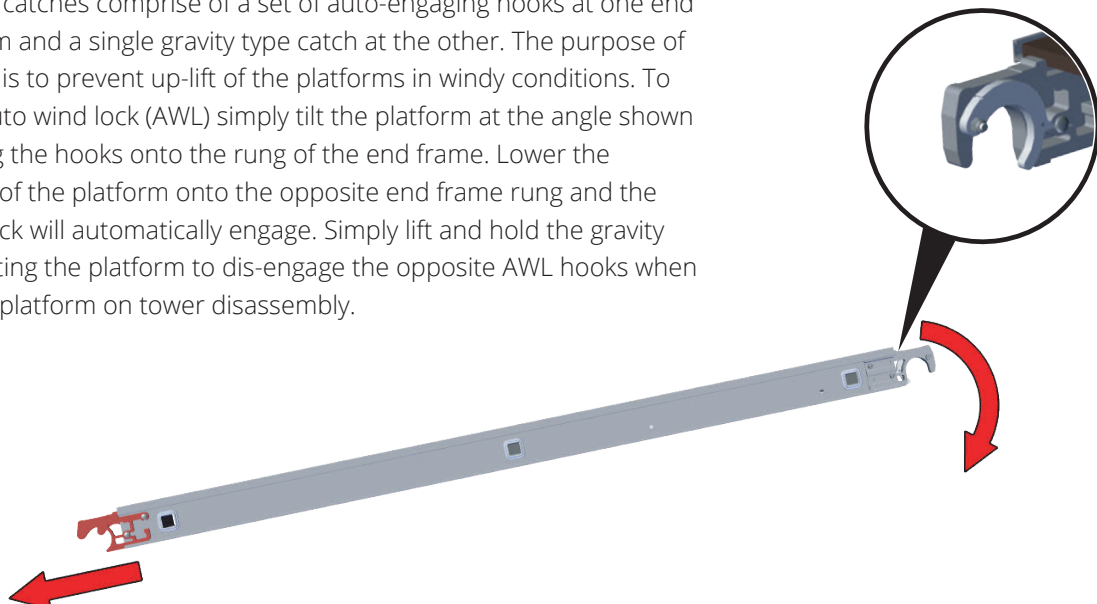

KNOW YOUR EIGERTOWER COMPONENTS

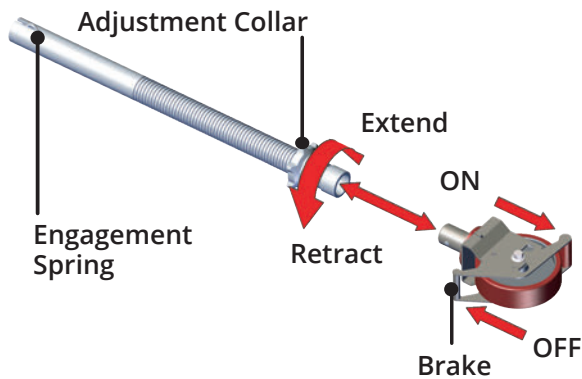

7 ADJUSTABLE LEG AND CASTOR

The adjustable leg and castor allows for accurate positioning of your EIGERTOWER in relation to your workplace. The leg can be extended or retracted to allow for levelling and the brake must be applied to prevent movement.

Do not use the adjustable legs of the wheels to increase the height of the tower. Only use the adjustable legs to level the tower. Make sure that the distance from the ground to the first step does not exceed 400 mm.

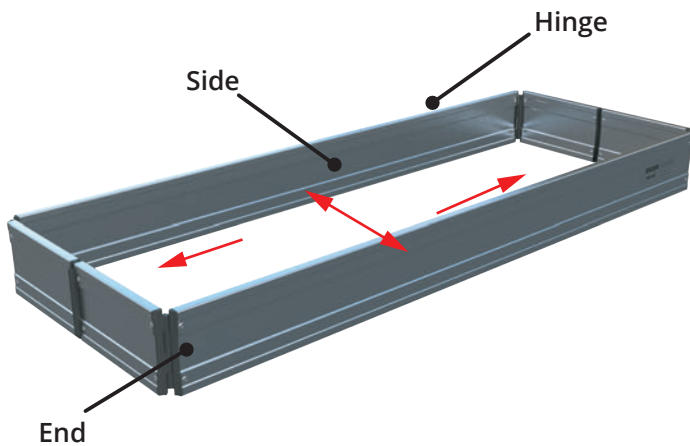

8 TOEBOARD

The toeboard, when placed on the working platform, prevents materials and tools from falling from the tower. It consists of folding side and end sections which are articulated via a series of hinges.

It can be opened and fitted over the platform edges by first unfolding the ends and sides as shown in the image to the left. Once unfolded, place all four lower inside edges over the outer edges of the platform.

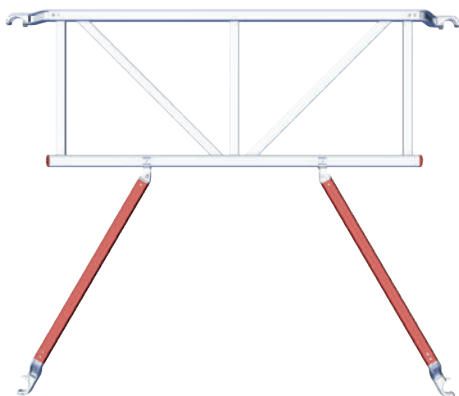

9 SAFE QUICK ADVANCE GUARDRAIL PANELS (SQ AGR)

The SQ AGR panels consist of both horizontal bracing and diagonal bracing members in a panel which can be attached to the tower from a safe guarded position. The horizontal bracing elements within the panel also act as a set of 'integral' guardrails and as such provides automatic guarding in advance to accessing the next level or lift of tower.

The panels are attached by means of the same type of triggered hook as the horizontal and diagonal braces. The triggered hooks are found at the end of the arms at the base of the panel and another pair of hooks can be found at the top of the panel. However these hooks are not triggered and are simply placed over the horizontal frame tubes. They have rubber inserts placed in the hooks to prevent the panels from slipping on the horizontal tubes.

The triggered hooks at the base are used to positively lock the panel in position. Place the upper hooks over the horizontal frame tube 2m above the assembly platform and then 'snap' the triggered hooks onto the lower horizontal frame tubes.

INSPECTION, CARE & MAINTENANCE

Keep all components clean and free from contaminants. If any part becomes contaminated with paint, acid, oils or similar products the tower must not be used until the effected components have been cleaned and re-inspected.

Particular attention should be paid to welded joints and any moving parts, such as brace claws, adjustable leg adjustment collars and stabiliser clamps. Ensure all safety decals are present, intact and readable.

A detailed Inspection Guide is available. To obtain a copy of this guide, please contact POP UP Products. Threads, hinges and brace claws may be lubricated with light oil to ensure correct functionality is maintained. Ensure oil does not contaminate climbing or walking surfaces.

All components should be stored in a dry location where they will be protected from adverse weather conditions. When storing or transporting, keep frames upright and platforms flat. Do not stack excessively to avoid stress damage. Please contact POP UP Products for further details on maintenance and repair of your EIGERTOWER components.

KNOW YOUR KIT LIST AND SPECIFICATIONS

COMPONENT MATRIX AND WEIGHTS - DOUBLE WIDTH (1450mm) - INTERNAL USE

COMPONENT SCHEDULE			INTERNAL USE																
DESCRIPTION	UNIT WEIGHT 1.8M (kg)	UNIT WEIGHT 2.5M (kg)	4.2 WH	4.7	5.7	6.2	6.7	7.7	8.2	8.7	9.7	10.2	10.7	11.7	12.2	12.7	13.7	14.2	
			2.2 PH	2.7	3.7	4.2	4.7	5.7	6.2	6.7	7.7	8.2	8.7	9.7	10.2	10.7	11.7	12.2	12.7
Castor	3.26	3.26	4	4	4	4	4	4	4	4	4	4	4	4	4	4	4	4	
Adjustable Leg	1.42	1.42	4	4	4	4	4	4	4	4	4	4	4	4	4	4	4	4	
2 Rung Ladder Frame	5.40	5.40	1	0	1	1	0	1	1	0	1	1	0	1	1	0	1	1	
2 Rung Frame	4.20	4.20	1	0	1	1	0	1	1	0	1	1	0	1	1	0	1	1	
3 Rung Ladder Frame	7.90	7.90	0	1	1	0	1	1	0	1	1	0	1	1	0	1	1	0	
3 Rung Frame	5.90	5.90	0	1	1	0	1	1	0	1	1	0	1	1	0	1	1	0	
4 Rung Ladder Frame	10.30	10.30	1	1	1	2	2	2	3	3	3	4	4	4	5	5	5	6	
4 Rung Frame	7.40	7.40	1	1	1	2	2	2	3	3	3	4	4	4	5	5	5	6	
Hatch Platform	13.25	18.00	1	2	2	2	3	3	3	4	4	4	5	5	5	6	6	6	
Standard Platform	12.56	17.31	1	1	1	1	1	1	1	1	1	1	1	1	1	1	1	1	
Safe Quick AGR Panel	7.07	8.77	2	2	4	4	4	6	6	6	8	8	8	10	10	10	12	12	
Horizontal Brace	1.73	2.22	2	2	2	2	2	2	2	2	2	2	2	2	2	2	2	2	
Diagonal Brace	1.90	2.32	2	2	2	2	2	2	2	2	2	2	2	2	2	2	2	2	
Toeboard Set	9.11	11.23	1	1	1	1	1	1	1	1	1	1	1	1	1	1	1	1	
Fixed Stabiliser	4.70	4.70	4	4	4	4	0	0	0	0	0	0	0	0	0	0	0	0	
Telescopic Stabiliser	6.44	6.44	0	0	0	0	4	4	4	4	4	4	4	4	4	0	0	0	
Semi Jumbo Stabiliser	8.20	8.20	0	0	0	0	0	0	0	0	0	0	0	0	0	4	4	4	
Total tower weight 1.8m			122	139	163	167	191	215	219	236	260	264	281	305	309	333	357	361	
Total tower weight 2.5m			138	161	188	192	221	248	252	274	301	305	327	355	358	388	415	419	

Total tower weight is rounded up to nearest kilogram

WH = Working Height
PH = Platform Height

COMPONENT MATRIX AND WEIGHTS - DOUBLE WIDTH (1450mm) - EXTERNAL USE

COMPONENT SCHEDULE			EXTERNAL USE										
DESCRIPTION	UNIT WEIGHT 1.8M (kg)	UNIT WEIGHT 2.5M (kg)	4.2 WH	4.7	5.7	6.2	6.7	7.7	8.2	8.7	9.7	10.2	
			2.2 PH	2.7	3.7	4.2	4.7	5.7	6.2	6.7	7.7	8.2	
Castor	3.26	3.26	4	4	4	4	4	4	4	4	4	4	
Adjustable Leg	1.42	1.42	4	4	4	4	4	4	4	4	4	4	
2 Rung Ladder Frame	5.40	5.40	1	0	1	1	0	1	1	0	1	1	
2 Rung Frame	4.20	4.20	1	0	1	1	0	1	1	0	1	1	
3 Rung Ladder Frame	7.90	7.90	0	1	1	0	1	1	0	1	1	0	
3 Rung Frame	5.90	5.90	0	1	1	0	1	1	0	1	1	0	
4 Rung Ladder Frame	10.30	10.30	1	1	1	2	2	2	3	3	3	4	
4 Rung Frame	7.40	7.40	1	1	1	2	2	2	3	3	3	4	
Hatch Platform	13.25	18.00	1	2	2	2	3	3	3	4	4	4	
Standard Platform	12.56	17.31	1	1	1	1	1	1	1	1	1	1	
Safe Quick AGR Panel	7.07	8.77	2	2	4	4	4	6	6	6	8	8	
Horizontal Brace	1.73	2.22	2	2	2	2	2	2	2	2	2	2	
Diagonal Brace	1.90	2.32	2	2	2	2	2	2	2	2	2	2	
Toeboard Set	9.11	11.23	1	1	1	1	1	1	1	1	1	1	
Fixed Stabiliser	4.70	4.70	4	4	4	4	0	0	0	0	0	0	
Telescopic Stabiliser	6.44	6.44	0	0	0	0	4	4	4	0	0	0	
Semi Jumbo Stabiliser	8.20	8.20	0	0	0	0	0	0	0	4	4	4	
Ballast Weight	20.00	20.00	0	0	0	0	0	3	4	4	7	9	
Total tower weight 1.8m (excl. ballast)			122	139	163	167	191	215	219	243	267	271	
Total tower weight 2.5m (excl. ballast)			138	161	188	192	221	248	252	281	308	312	

Total tower weight is rounded up to nearest kilogram

WH = Working Height
PH = Platform Height

Please note : Towers to be used externally, or if they are to be exposed to wind forces, need to be chosen from the external use table above. This table includes the required quantities of ballast. Externally used towers can also be tied into a stable structure, negating the use of ballast. Further guidance can be found on page 10.

KNOW YOUR KIT LIST AND SPECIFICATIONS

COMPONENT MATRIX AND WEIGHTS - SINGLE WIDTH (850mm) - INTERNAL USE

COMPONENT SCHEDULE			INTERNAL USE ONLY																
DESCRIPTION	UNIT WEIGHT 1.8M (kg)	UNIT WEIGHT 2.5M (kg)	4.2 WH	4.7	5.7	6.2	6.7	7.7	8.2	8.7	9.7	10.2	10.7	11.7	12.2	12.7	13.7	14.2	
			2.2 PH	2.7	3.7	4.2	4.7	5.7	6.2	6.7	7.7	8.2	8.7	9.7	10.2	10.7	11.7	12.2	12.7
Castor	3.26	3.26	4	4	4	4	4	4	4	4	4	4	4	4	4	4	4	4	4
Adjustable Leg	1.42	1.42	4	4	4	4	4	4	4	4	4	4	4	4	4	4	4	4	4
2 Rung Ladder Frame	4.60	4.60	1	0	1	1	0	1	1	0	1	1	0	1	1	0	1	1	1
2 Rung Frame	3.20	3.20	1	0	1	1	0	1	1	0	1	1	0	1	1	0	1	1	1
3 Rung Ladder Frame	6.70	6.70	0	1	1	0	1	1	0	1	1	0	1	1	0	1	1	0	0
3 Rung Frame	4.50	4.50	0	1	1	0	1	1	0	1	1	0	1	1	0	1	1	0	0
4 Rung Ladder Frame	8.70	8.70	1	1	1	2	2	2	3	3	3	4	4	4	5	5	5	6	6
4 Rung Frame	5.70	5.70	1	1	1	2	2	2	3	3	3	4	4	4	5	5	5	6	6
Hatch Platform	13.25	18.00	1	2	2	2	3	3	3	4	4	4	5	5	5	6	6	6	6
Safe Quick AGR Panel	7.07	8.77	2	2	4	4	4	6	6	6	8	8	8	10	10	10	12	12	12
Horizontal Brace	1.73	2.22	2	2	2	2	2	2	2	2	2	2	2	2	2	2	2	2	2
Diagonal Brace	1.90	2.32	1	1	1	1	1	1	1	1	1	1	1	1	1	1	1	1	1
Toeboard Set	7.40	9.52	1	1	1	1	1	1	1	1	1	1	1	1	1	1	1	1	1
Fixed Stabiliser	4.70	4.70	4	4	4	4	0	0	0	0	0	0	0	0	0	0	0	0	0
Telescopic Stabiliser	6.44	6.44	0	0	0	0	4	4	4	4	4	4	4	4	4	0	0	0	0
Semi Jumbo Stabiliser	8.20	8.20	0	0	0	0	0	0	0	0	0	0	0	0	0	4	4	4	4
Total tower weight 1.8m			100	117	139	142	166	188	191	208	229	233	249	271	274	298	320	323	
Total tower weight 2.5m			112	133	159	162	190	216	219	240	266	269	290	316	319	347	373	376	

Total tower weight is rounded up to nearest kilogram

WH = Working Height
PH = Platform Height

COMPONENT MATRIX AND WEIGHTS - SINGLE WIDTH (850mm) - EXTERNAL USE

COMPONENT SCHEDULE			EXTERNAL / INTERNAL USE									
DESCRIPTION	UNIT WEIGHT 1.8M (kg)	UNIT WEIGHT 2.5M (kg)	4.2 WH	4.7	5.7	6.2	6.7	7.7	8.2	8.7	9.7	10.2
			2.2 PH	2.7	3.7	4.2	4.7	5.7	6.2	6.7	7.7	8.2
Castor	3.26	3.26	4	4	4	4	4	4	4	4	4	4
Adjustable Leg	1.42	1.42	4	4	4	4	4	4	4	4	4	4
2 Rung Ladder Frame	4.60	4.60	1	0	1	1	0	1	1	0	1	1
2 Rung Frame	3.20	3.20	1	0	1	1	0	1	1	0	1	1
3 Rung Ladder Frame	6.70	6.70	0	1	1	0	1	1	0	1	1	0
3 Rung Frame	4.50	4.50	0	1	1	0	1	1	0	1	1	0
4 Rung Ladder Frame	8.70	8.70	1	1	1	2	2	2	3	3	3	4
4 Rung Frame	5.70	5.70	1	1	1	2	2	2	3	3	3	4
Hatch Platform	13.25	18.00	1	2	2	2	3	3	3	4	4	4
Safe Quick AGR Panel	7.07	8.77	2	2	4	4	4	6	6	6	8	8
Horizontal Brace	1.73	2.22	2	2	2	2	2	2	2	2	2	2
Diagonal Brace	1.90	2.32	1	1	1	1	1	1	1	1	1	1
Toeboard Set	7.40	9.52	1	1	1	1	1	1	1	1	1	1
Fixed Stabiliser	4.70	4.70	4	4	4	4	0	0	0	0	0	0
Telescopic Stabiliser	6.44	6.44	0	0	0	0	4	4	4	0	0	0
Semi Jumbo Stabiliser	8.20	8.20	0	0	0	0	0	0	0	4	4	4
Ballast Weight	20.00	20.00	0	0	0	0	1	2	3	3	4	7
Total tower weight 1.8m (excl. ballast)			100	117	139	142	166	188	191	215	237	240
Total tower weight 2.5m (excl. ballast)			112	133	159	162	190	216	219	247	273	276

Total tower weight is rounded up to nearest kilogram

WH = Working Height
PH = Platform Height

Please note : Towers to be used externally, or if they are to be exposed to wind forces, need to be chosen from the external use table above. This table includes the required quantities of ballast. Externally used towers can also be tied into a stable structure, negating the use of ballast. Further guidance can be found on page 10.

SAFETY DOS AND DON'TS - ALWAYS

- 1 Always read and understand this guide before you begin assembly.
- 2 Always ensure that all safety requirements are met and that EIGERTOWER is the correct access solution for the task you wish to perform.
- 3 Always ensure that EIGERTOWER is assembled and dismantled by a qualified, competent person.
- 4 Always cordon off the work area creating a zone with a radius that is 1m greater than the total height of EIGERTOWER.
- 5 Always wear the correct Personal Protective Equipment for the task being performed. Gloves, steel toecap boots, a hard hat and suitable clothing must be worn by all persons.
- 6 Always tie back long hair and remove items of loose jewellery.
- 7 Always perform a full risk assessment prior to assembling or using EIGERTOWER and abide by your findings.
- 8 Always prevent access to unauthorised persons if you have no other option but to leave EIGERTOWER unattended and if this is not possible then EIGERTOWER must be dismantled.
- 9 Always make tools and materials required for the assembly of your EIGERTOWER are made available on site.
- 10 Always ensure you properly assess the risk/method if tools or materials are hoisted to the platform via a rope.
- 11 Always access platforms from within EIGERTOWER and via the 4 rung frames positioned at the platform's trap door end. Keep your feet in the middle of the rungs and grip the upper rungs with your hands.
- 12 Always erect EIGERTOWER on smooth level ground that is capable of supporting its own weight, the user and any tools or materials without subsidence and free of obstructions.
- 13 Always use your EIGERTOWER in accordance with the instructions contained within this assembly guide.
- 14 Always use your EIGERTOWER in accordance with National Regulations.
- 15 Always remove persons and loose materials from your EIGERTOWER before attempting to move it.

SAFETY DOS AND DON'TS - NEVER

- 1 Never use EIGERTOWER if you don't understand something in this guide; please contact the supplier for advice.
- 2 Never assemble, use, move or dismantle EIGERTOWER if you are tired or unwell or if you are under the influence of alcohol or drugs.
- 3 Never use EIGERTOWER in adverse weather conditions which may endanger the user.
- 4 Never use in wind conditions of Beaufort Force 5 and above. Please be aware of the tunnel effect caused by buildings close to each other. Dismantle the EIGERTOWER if wind reaches Beaufort 6.
- 5 Never assemble or use EIGERTOWER near overhead hazards such as power lines that are within reach of EIGERTOWER or the user.
- 6 Never ascend or descend your EIGERTOWER if both hands are not free.
- 7 Never add banners, notice boards, etc. to EIGERTOWER or suspend weights from the tower.
- 8 Never use MITOWER if contaminated by paint, chemicals, etc.
- 9 Never overload the platforms (see page 2 for details).
- 10 Never suspend EIGERTOWER from another structure.
- 11 Never lean from EIGERTOWER and never apply undue side force (max 200N)
- 12 Never stand on the guardrails, toe boards, boxes (or similar) to gain extra height. If the working height is insufficient either construct EIGERTOWER to the required height or use an alternative method.
- 13 Never use damaged components in your EIGERTOWER assembly.
- 14 Never use more than one working platform in your EIGERTOWER.
- 15 Never allow more than one person on a working platform.
- 16 Never use EIGERTOWER as a means to enter or exit other structures, or as a means of edge protection.
- 17 Never exceed a distance between platforms of 2.0m except for the first platform which can be 3.4m from the ground.
- 18 Never bridge between towers or other structures.
- 19 Never stand on an unguarded platform.
- 20 Never move the tower with people or materials on it.
- 21 Never lift the tower with mechanical equipment.
- 22 Never climb the outside of the tower.

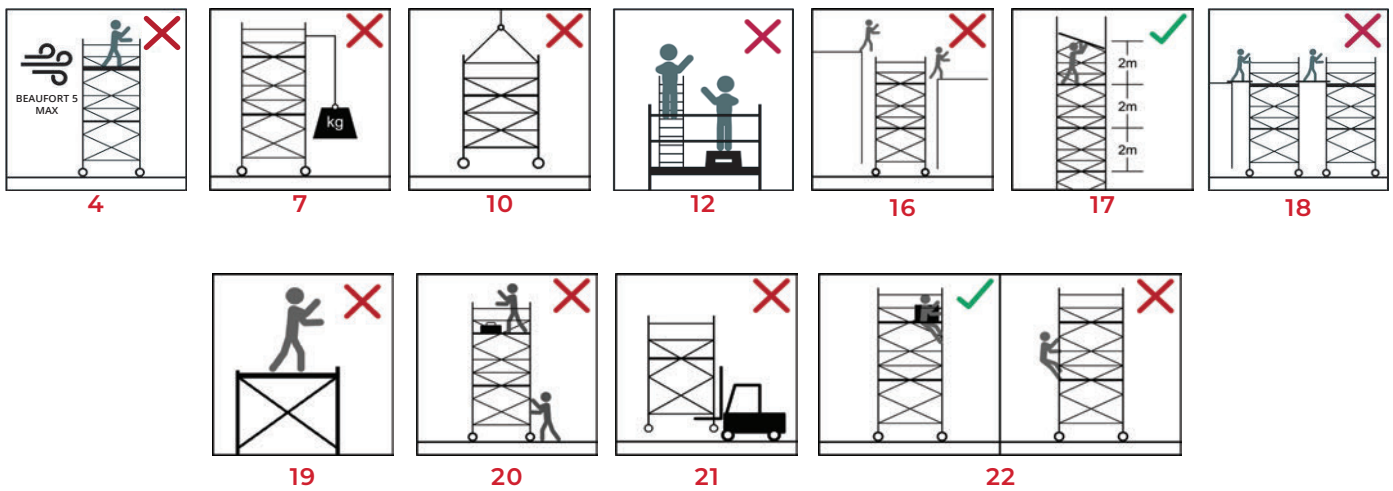

BEFORE YOU START

PREPARATION

The floor area must be clear of any obstructions including materials and debris. Check that you have all the components necessary to construct the tower height you require. Check also each component for condition and correct function. If any part is missing or damaged/not working correctly it must be replaced before assembling. Assess the height of tower required before attempting assembly. Refer to component matrices on pages 6 & 7 for the correct component quantities and if required, ballast for the chosen platform height. Please note working height is generally calculated as two meters above platform height.

3T (THROUGH THE TRAPDOOR) SYSTEM

The 3T method of construction has been developed to reduce the risk of an erector falling from a tower during construction. The erector must sit on the platform with legs through the hatch and feet on the frame rungs when attaching guardrail brace panels above the platform. This ensures the erector is always protected by a set of guardrail brace panels.

TYING IN

You should consider tying in the tower to add stability, but this may only be carried out by a suitably trained person.

BALLAST

Where shown in the component matrices, ballast must be used to stabilise against overturning. Only use solid materials as ballast (i.e. no loose materials) and position to avoid overloading individual components. Ballast should be attached to the horizontal rungs of your EIGERTOWER and be either securely fastened or be of a design to prevent accidental removal. An example of such ballast is shown below. The quantity of ballast is shown in the component matrices on page 6&7.

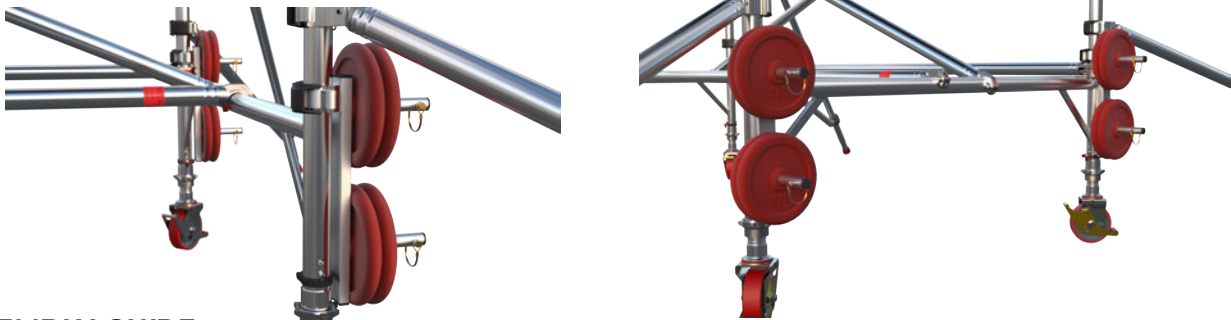

ASSEMBLY GUIDE

These instructions must always be made available to the user. If replacement copies are required, please contact your supplier. This assembly guide is to be made available on the location of use of this EIGERTOWER.

DAMAGED COMPONENTS

Regularly inspect all components for damage. Damaged components must be quarantined so that they cannot be used. Where safe to do so, the component can be repaired but only by a qualified repairer. If in doubt contact your supplier for advice.

DISMANTLING YOUR EIGERTOWER

EIGERTOWER is easily dismantled by simply reversing the erection procedure. Make sure that the component hangers are evenly loaded to ensure your EIGERTOWER remains balanced. You must, however, be protected by guardrail brace panels when standing on any platform and ensure that you use the 3T method when removing guardrail brace panels.

AFTER ASSEMBLY

After assembly the following information needs to be displayed on the access tower and should be clearly visible from the ground (e.g. on a Scafftag).

- The name & contact details of the responsible person
- If the tower is ready for application or not.
- The load class and Uniformly Distributed Load.
- If the access tower is intended for indoor use only.
- The date of assembly.

GETTING STARTED

GETTING STARTED

The Eiger 250 tower is available in two base sizes, 1450mm by a 1.8m or 2.5m platform length. The tower will be supplied with various height frames and you must always start with the smallest size frames first. The following instructions deal with a tower using 4 rung frames at the start, if supplied with 6 rung frames instead of 4 rung, start with the 6 rung frames.



Where you have both 4 rung and 6 rung, you must use the 4 rung and 6 rung, you must use the 4 rung first and the 6 rung next, with (where applicable) 8 rung frames at the top. The first platform needs to be carefully positioned to ensure that the remaining tower is constructed safely.

The access tower requires a minimum of two persons to assemble it, do not attempt to assemble the tower on your own.

STABILISERS POSITIONING

Stabilisers are supplied and must be fitted where specified. Please refer to the component matrices on page 6 for the correct type of stabiliser to use according to the platform height required..

For maximum effect arrange the stabilisers by positioning at an angle of 30 degrees to give a footprint as close to as shown in fig. 1.

If the tower is to be positioned against a wall, the stabiliser footprint can be altered as shown in figs. 2 & 3, but only where the heights of the wall is a minimum of two thirds the height of the top working platform.

Ensure that all four stabilisers' feet are in contact with the ground and that the ground can support the weight of the tower and stabilisers.

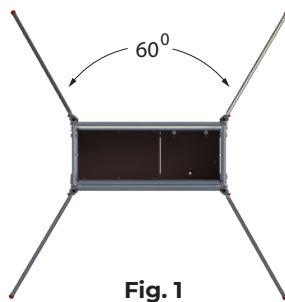

Fig. 1

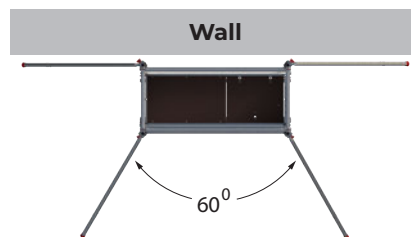

Fig. 2

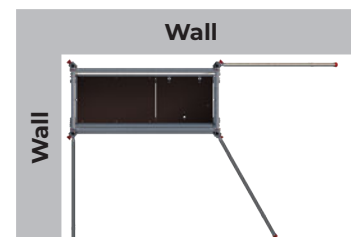

Fig. 3

MOVING YOUR EIGERTOWER

When your EIGERTOWER needs to be moved a small distance to enable you to continue your task, this can be achieved provided the stabilisers can remain in pattern and all tools, materials and personnel are removed from the tower.

Assess the route of travel, avoiding overhead obstacles such as power lines before moving your EIGERTOWER.

You will need to raise the stabilisers so that they are no more than 25mm above the floor and properly locked.

However, if the stabilisers have to be repositioned and this reduces the footprint, your EIGERTOWER must be reduced in height to 2m.

You must only move EIGERTOWER by manual effort, at a slow pace and only after fully assessing the risk. Once moved, always check EIGERTOWER before using ensuring it is level within the inclination of 1% before using it.

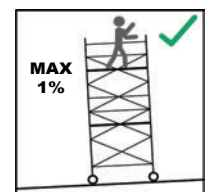

If EIGERTOWER is to be moved to a new location, a new level or over rough terrain, it must be fully dismantled and rebuilt at the new location. Your EIGERTOWER is only to be moved on flat obstacle free solid ground (0% Slope).

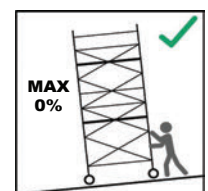

EIGER 500 SQ AGR ASSEMBLY GUIDE

DOUBLE WIDTH 1450 TOWER 4.2M PLATFORM HEIGHT

BUILD PROCESS

STEP 1

Insert castor / adjustable leg assemblies into base of 2 rung ladder frame and one 2 rung frame.

Press down firmly on the braking mechanism to lock castors.

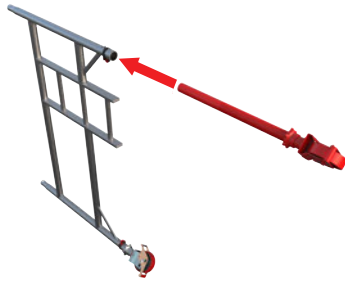

STEP 2

Fit a horizontal brace onto the vertical tube of the 2 rung ladder frame, resting directly on the first horizontal tube.

Ensure that the brace hook trigger faces to the outside of the tower.



STEP 3

Join the 2 rung frame to the ladder frame, ensuring that the brace hook is resting on the opposite horizontal rung. Fit the second brace to the horizontal tubes as shown with hook apertures facing downwards. Level around base of tower using spirit level, making adjustments as necessary to adjustable legs until the frames have an inclination no more than 1% from the vertical. Do not use the adjustable legs of the wheels to increase the height of the scaffold. Only use the adjustable legs to level the scaffold. Ensure that the distance from the ground to the first step does not exceed 400 mm.



STEP 4

Locate 4 rung frames and fit diagonal braces as shown.



STEP 5

Locate two AGR panels with the upper hooks of the panels on the sixth rungs of the frames and the lower hooks of the panels onto the third rungs. The panels should be spaced to allow the platform to be placed between the lower arms of the panels, with minimum clearance between the arms and the sidebearers of the platform.



STEP 6

Locate hatch platform on the fourth rung / 2.20m level, ensuring that the hatch door opens outwards. Possible re-adjustment of the AGR panels may be required to ensure a close fit of the lower arms of the panels against the platform sidebearers.



STEP 7

Attach four stabilisers, one to each corner of the tower. Place the upper coupler of the stabiliser under the third rung of the frame and the lower coupler above the first rung of the frame. Adjust the upper and lower coupler positions until the stabiliser foot is in contact with the ground.

Please refer to the 'Stabilisers' section for details on achieving an optimum stabiliser footprint.



STEP 8

Fit next lift of 4 rung frames.



STEP 9

Locate next set of AGR panels. Position top hooks of AGR panels on horizontal tubes of the tenth rungs of the frames before attempting to locate the lower triggered hooks. Ensure lower hooks are positively locked onto the horizontal rungs and the AGR panels are vertical and parallel to each other.

The panels should be spaced to allow the platforms to be placed between the lower arms of the panels, with enough clearance between the arms and the sidebearers of the platform to allow the toeboard to be located at a latter stage (Step 11).



STEP 10

Locate both hatch and standard platforms to the eighth rungs of the frames. Possible re-adjustment of the AGR panels may be required to ensure a close fit of the lower arms of the panels against the platforms sidebearers.

NOTE: If building the tower beyond the 4.20m level, continue with steps 8, 9 & 10 until the desired height is achieved, then follow step 11.



STEP 11

Fit the toeboard set ensuring the edges of the toeboard overlap the platform edges on all four edges.

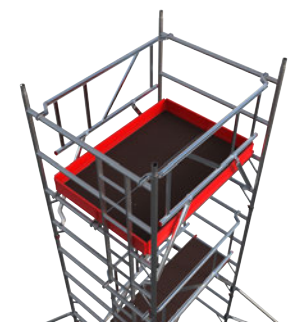

EIGER 500 SQ AGR ASSEMBLY GUIDE

SINGLE WIDTH 850 TOWER 3.7M PLATFORM HEIGHT

BUILD PROCESS

STEP 1

Insert castor / adjustable leg assemblies into base of 2 rung ladder frame and one 2 rung frame.

Press down firmly on the braking mechanism to lock castors.

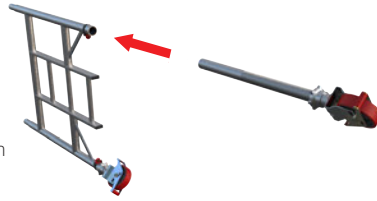

STEP 2

Fit a horizontal brace onto the vertical tube of the 2 rung ladderframe, resting directly on the first horizontal tube. Ensure that the brace hook trigger faces to the outside of the tower.



STEP 3

Join the 2 rung frame to the ladderframe, ensuring that the brace hook is resting on the opposite horizontal rung. Fit the second brace to the horizontal tubes as shown with hook apertures facing downwards. Level around base of tower using spirit level, making adjustments as necessary to adjustable legs until the frames have an inclination no more than 1% from the vertical. Do not use the adjustable legs of the wheels to increase the height of the scaffold. Only use the adjustable legs to level the scaffold. Ensure that the distance from the ground to the first step does not exceed 400 mm.



STEP 4

Locate one 3 rung ladderframe, one 3 rung frame and fit one diagonal brace as shown.



STEP 5

Locate two AGR panels with the upper hooks of the panels on the fifth rungs of the frames and the lower hooks of the panels onto the second rungs. The panels should be spaced to allow the platform to be placed between the lower arms of the panels, with minimum clearance between the arms and the sidebearers of the platform.



STEP 6

Locate hatch platform on the third rung / 1.70m level, ensuring that the hatch door opens outwards. Possible re-adjustment of the AGR panels may be required to ensure a close fit of the lower arms of the panels against the platform sidebearers.

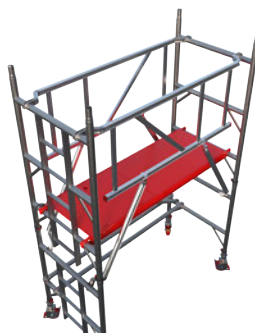

STEP 7

Attach four stabilisers, one to each corner of the tower. Place the upper coupler of the stabiliser under the third rung of the frame and the lower coupler above the first rung of the frame. Adjust the upper and lower coupler positions until the stabiliser foot is in contact with the ground.

Please refer to the 'Stabilisers' section for details on achieving an optimum stabiliser footprint.



STEP 8

Fit next lift of 4 rung frames.

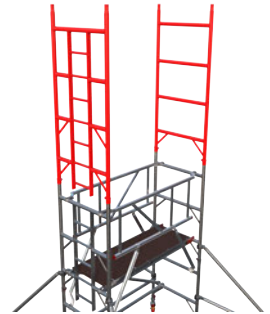

STEP 9

Locate next set of AGR panels. Position top hooks of AGR panels on horizontal tubes of the ninth rungs of the frames before attempting to locate the lower triggered hooks. Ensure lower hooks are positively locked onto the horizontal rungs and the AGR panels are vertical and parallel to each other.

The panels should be spaced to allow the platforms to be placed between the lower arms of the panels, with enough clearance between the arms and the sidebearers of the platform to allow the toeboard to be located at a latter stage (Step 11).

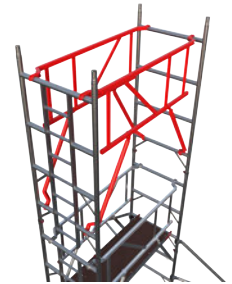

STEP 10

Locate both hatch and standard platforms to the seventh rungs of the frames.

NOTE: If building the tower beyond the 3.70m level, continue with steps 8, 9 & 10 until the desired height is achieved, then follow step 11.



STEP 11

Fit the toeboard set ensuring the edges of the toeboard overlap the platform edges on all four sides.



10 POINT PRE-USE SAFETY CHECKLIST

10 POINT PRE-USE CHECKLIST FOR USERS

1	BEFORE USE	Ensure tower is correct, complete and level.
2	COMPONENTS	Check all components are free from damage.
3	CASTORS	Ensure they are locked.
4	ENVIRONMENT	No environmental changes have influenced the safe use of your tower.
5	STABILISER COUPLER CLAMPS	Check they are secure & correctly attached.
6	GUARDRAILS	Make sure all platforms are fully enclosed by guardrails.
7	BRACE CLAWS	Check they are locked correctly.
8	WINDLOCK CATCHES	Make sure they are engaged.
9	FRAME CLIPS	Make sure they are engaged.
10	TOE BOARDS	Check they are correctly positioned on the platform.

REGISTRATIONS

ISO 9001

**EN 1004
Class 3**



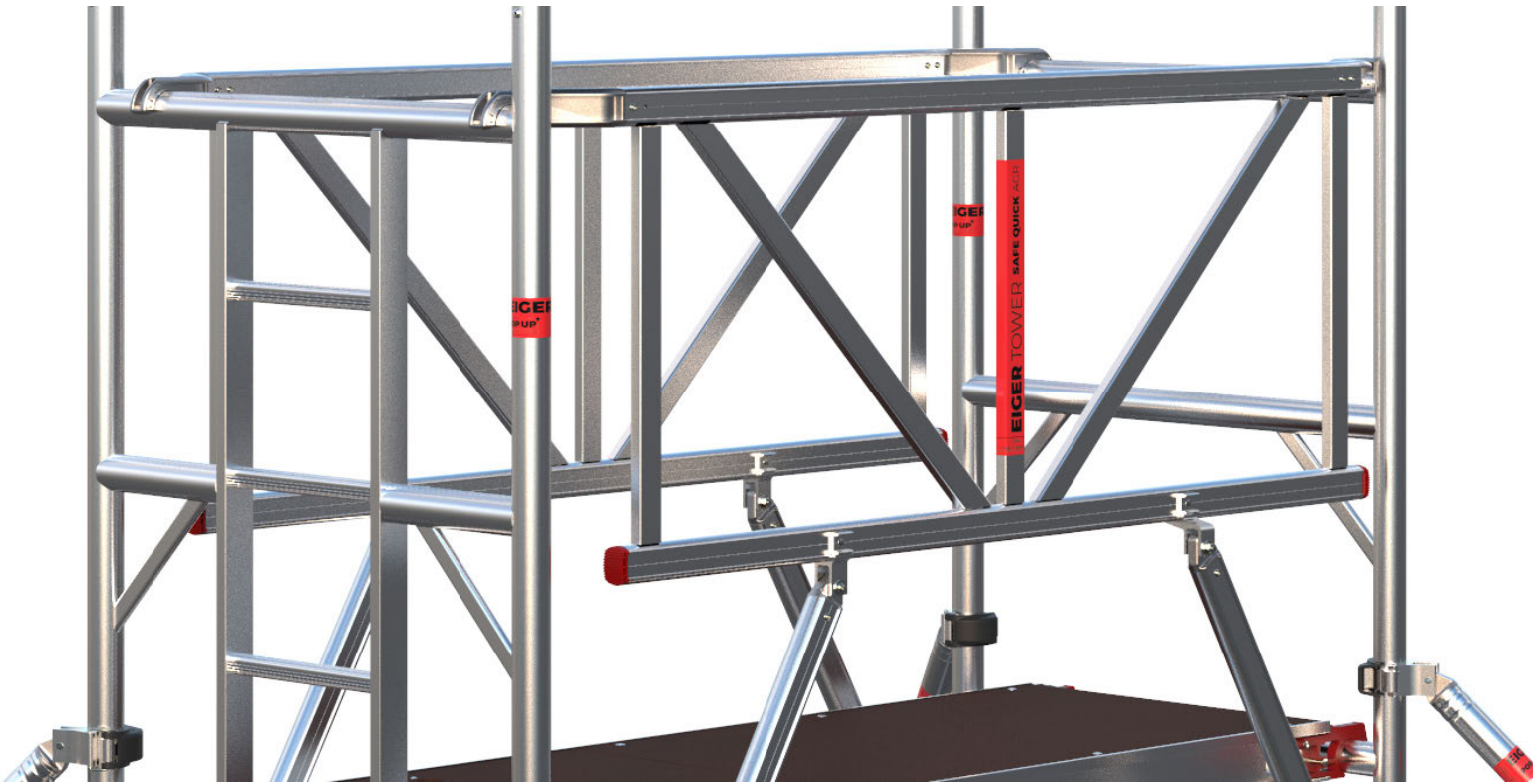

POP UP Products
Unit E1, Tenth Avenue
Deeside Industrial Park
Deeside
Flintshire
CH5 2UA