

# MI TOWER STAIRS



INSTRUCTION MANUAL EN 1004-2-en  
(Rev.01 13-06-24)



+44(0)1244 833 933



info@popupproducts.co.uk



popupproducts.co.uk



# INSTRUCTION MANUAL FOR MITOWER STAIRS

## CONTENTS

CONTENTS	1	GETTING STARTED	11
INTRODUCTION	2	MITOWER STAIRS 2.2M - 4.2M - ASSEMBLY	12
KNOW YOUR MITOWER STAIRS	3	MITOWER STAIRS 2.7M - 4.7M - ASSEMBLY	15
KNOW YOUR MITOWER STAIRS COMPONENTS	4	10 POINT PRE-USE SAFETY CHECKLIST	18
KNOW YOUR KIT LIST AND SPECIFICATIONS	6	REGISTRATIONS	20
KNOW YOUR STORAGE AND TRANSPORT PACK	7		
SAFETY DOS AND DON'TS - ALWAYS	8		
SAFETY DOS AND DON'TS - NEVER	9		
BEFORE YOU START	10		

# INTRODUCTION

MI TOWER STAIRS is a versatile and high quality mobile access tower providing one work platform for one person used throughout the building and construction industry for both indoor and outdoor access solutions, where a stable and secure platform is required. Ideal for maintenance and installation work or short term access. It is designed in accordance with the latest testing and quality standards. MI TOWER STAIRS complies with BS EN 1004 -1 : 2020 and WAHR with vertical ladder access and designed for Class 3 loadings. Platform heights between 2.2m & 4.7m internal / external. Tower designation is EN1004-3-2/4-XXXD-H2.

This instruction manual is in compliance with BS EN 1004-2-en.

Verification and assessment documentation is held by POP UP Products Ltd.

Our priority is to help ensure the safe operation of our products, so please pay particular attention to the safety tips on pages 8 & 9.

We want you to enjoy the safe and responsible use of MI TOWER STAIRS with the minimum of fuss and this guide is designed to get you up and running as quickly and as safely as possible.

We recommend that you read this guide prior to assembling and using your MI TOWER STAIRS.

This instruction manual shall be available on the location of use of your MI TOWER STAIRS .

Your MI TOWER STAIRS shall only be used in accordance with this assembly guide without modification and national regulations.

User training courses cannot be a substitute for instruction manuals but only complement them.

This product shall only be used according to the instruction manual.

Only original Pop Up Products MI TOWER STAIRS components, in undamaged condition as specified in this instruction manual, shall be used to assemble this access tower.

Pop Up Products Limited cannot accept responsibility in the event of an accident occurring because of mixing components from different manufacturers.

Mobile access and working towers designed in accordance with EN 1004-1 are not anchor points for personal fall arrest equipment.

Working is only permitted on a platform with complete side protection, including guardrails and toeboards.

Maximum uniformly distributed load permitted on a single platform is 150Kg, ensuring the hatch area is always kept clear of materials to allow unimpeded access to the platform.

**Visit** PASMA and HSE for further reference.

# KNOW YOUR MI TOWER STAIRS

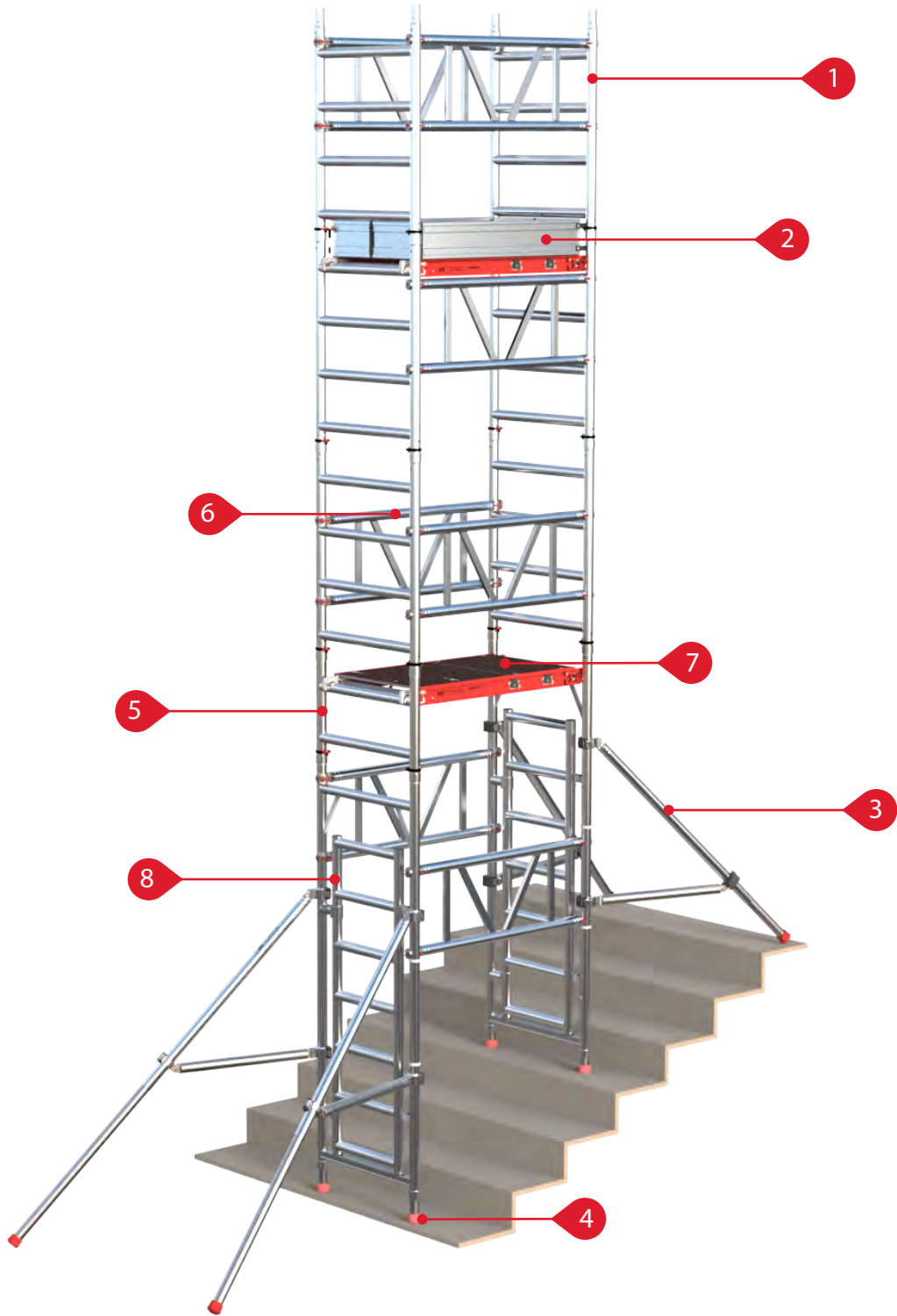

## PARTS LISTING

1	4 RUNG FRAME	5	2 RUNG FRAME
2	TOE BOARD	6	GUARDRAIL BRACE PANEL
3	TELESCOPIC STABILISER	7	HATCH PLATFORM
4	ADJUSTABLE LEG AND FOOT	8	WALK-THROUGH FRAME

# KNOW YOUR MI TOWER STAIRS COMPONENTS

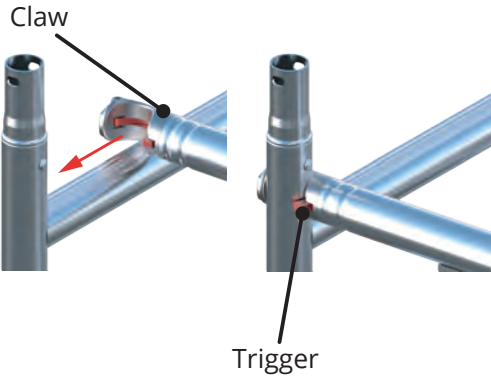

## 1 GUARDRAIL BRACE PANEL

Claws are fitted to the guardrail brace panels and each has an automatic locking jaw which is released by simply moving the jaw's trigger. The claw must only be attached to the frame with the opening facing outward. Attachment with the jaw's opening facing inward will not fully protect the user if lent upon and may cause serious injury or death. Always ensure that each claw is positively locked in position before using your tower. Removal of the guardrail brace panel is simply a reversal of the attachment sequence

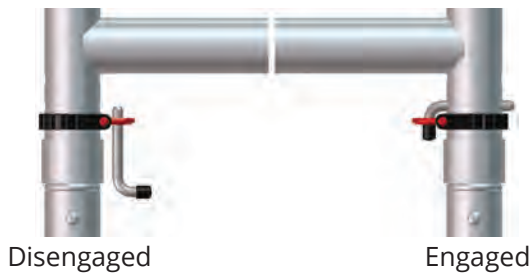

## 2 FRAME CLIPS

The frame clip's pin locates into a retaining hole in the frames to lock tower sections together when placed one on top of the other. The pin is locked in place by a red tab to ensure that it remains in place. From the disengaged position, pivot the pin / tab to bring the pin horizontal. Insert the pin fully through the retaining hole with its tail pointing down. Next flip the tab, vertically, to lock the pin in place. Removal is simply a reversal of the fitting sequence.



## 3 STABILISER COUPLER CLAMP

The coupler clamps are used to secure the stabilisers to the tower's vertical tubing. With the clamp jaw open, offer it to the tube. Bring the jaw around the tube and set the buckle on to the hook, then close the clamp arm to lock the stabiliser in position. A similar clamp is fitted to the stabiliser extension leg. Removal of the stabiliser coupler clamp is simply a reversal of the attachment sequence.

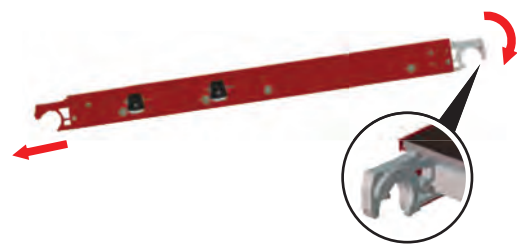

## 4 WIND-LOCK CATCH

The wind lock catches comprise of a set of auto-engaging hooks at one end of the platform and a single gravity type catch at the other. The purpose of these devices is to prevent up-lift of the platforms in windy conditions. To engage the auto wind lock (AWL) simply tilt the platform at the angle shown before placing the hooks onto the rung of the end frame. Lower the opposite end of the platform onto the opposite end frame rung and the gravity type lock will automatically engage. Simply lift and hold the gravity lock before tilting the platform to dis-engage the opposite AWL hooks when removing the platform on tower disassembly.

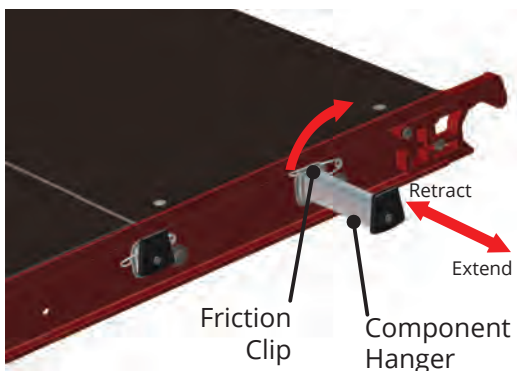

## 5 PLATFORM WITH BUILT IN COMPONENT HANGERS

To enable one man to erect MI TOWER products, each hatch is fitted with four component hangers which are stowed (two either side) within the platform's frame. The hangers can be extended when needed and retracted when not.

To extend a hanger simply pull up the friction clip and pull the component hanger until it stops. To retract the hanger, simply reverse the procedure.

# KNOW YOUR MITOWER STAIRS COMPONENTS

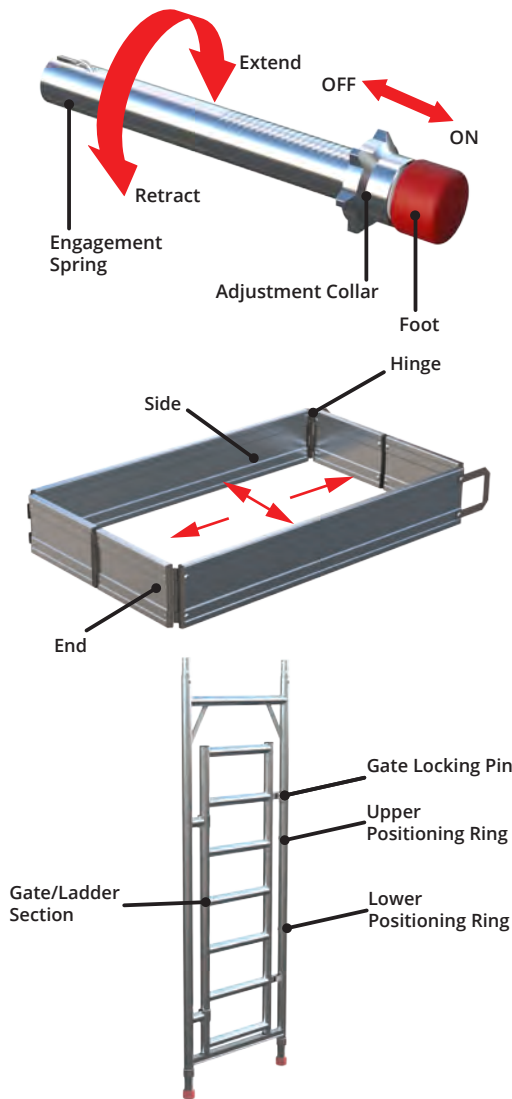

## 7 ADJUSTABLE LEG AND FOOT

The adjustable leg and foot allows for accurate positioning of your MI TOWER STAIRS in relation to your workplace. The leg can be extended or retracted to allow for levelling while the foot keeps the tower stable.

## 8 TOEBOARD

The toeboard, when placed on the working platform, prevents materials and tools from falling from the tower. It consists of folding side and end sections which are articulated via a series of hinges.

It can be opened and fitted over the platform edges by first unfolding the ends and sides as shown in the image to the left. Once unfolded, place all four lower inside edges over the outer edges of the platform.

## 9 WALK-THROUGH FRAME

The walk-through gate frame includes a gate/ladder which is used to access the upper levels of the Mi TOWER STAIRS and once unlocked and opened, allows access into and through the base of the MI TOWER STAIRS. To open the gate/ladder remove the clip and lift the gate/ladder upwards. It can now be swung inwards or outwards to allow access. The vertical tubes also feature positioning rings that will be used when building the Mi TOWER STAIRS and allow the guardrail brace panel hooks to be correctly positioned.

## INSPECTION, CARE & MAINTENANCE

Keep all components clean and free from contaminants. If any part becomes contaminated with paint, acid, oils or similar products the tower must not be used until the effected components have been cleaned and re-inspected.

Particular attention should be paid to welded joints and any moving parts, such as brace claws, adjustable leg adjustment collars and stabiliser clamps. Ensure all safety decals are present, intact and readable.

A detailed Inspection Guide is available. To obtain a copy of this guide, please contact POP UP Products.

Threads, hinges and brace claws may be lubricated with light oil to ensure correct functionality is maintained. Ensure oil does not contaminate climbing or walking surfaces.

All components should be stored in a dry location where they will be protected from adverse weather conditions. When storing or transporting, keep frames upright and platforms flat. Do not stack excessively to avoid stress damage.

Please contact POP products for further details on maintenance and repair of your MI TOWER STAIRS components.

# KNOW YOUR KIT LIST AND SPECIFICATIONS

## COMPONENT WEIGHTS AND MATRIX

COMPONENT	Weight (Unit) kg	WH	4.2m	4.7m	6.2m	6.7m
		PH	2.2m qty	2.7m qty	4.2m qty	4.7m qty
4 RUNG END FRAME	3.58		3	2	7	6
TELESCOPIC OUTRIGGER	3.58		4	4	4	4
HATCH PLATFORM	8.56		1	1	2	2
GUARDRAIL BRACE PANEL	3.34		4	4	7	7
220MM ADJUSTABLE LEG C/W RUBBER FOOT	0.91		4	4	4	4
WALK-THROUGH GATE FRAME	9.29		1	2	1	2
TOE BOARD SET	5.33		1	1	1	1
2 RUNG FRAME	2.01		1	1	1	1
MI TOWER STAIRS WEIGHT (kg)			67.69	73.43	100.99	106.73
MAXIMUM UNIFORMLY DISTRIBUTED LOAD			150kg	150kg	150kg	150kg

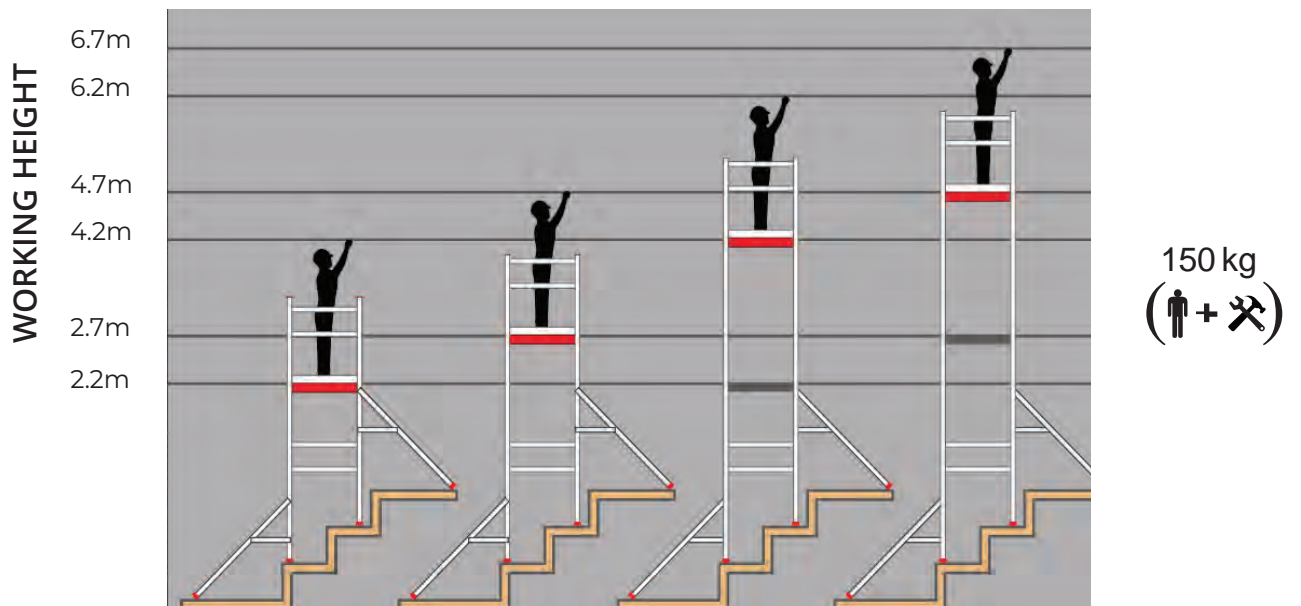

# KNOW YOUR STORAGE AND TRANSPORT PACK

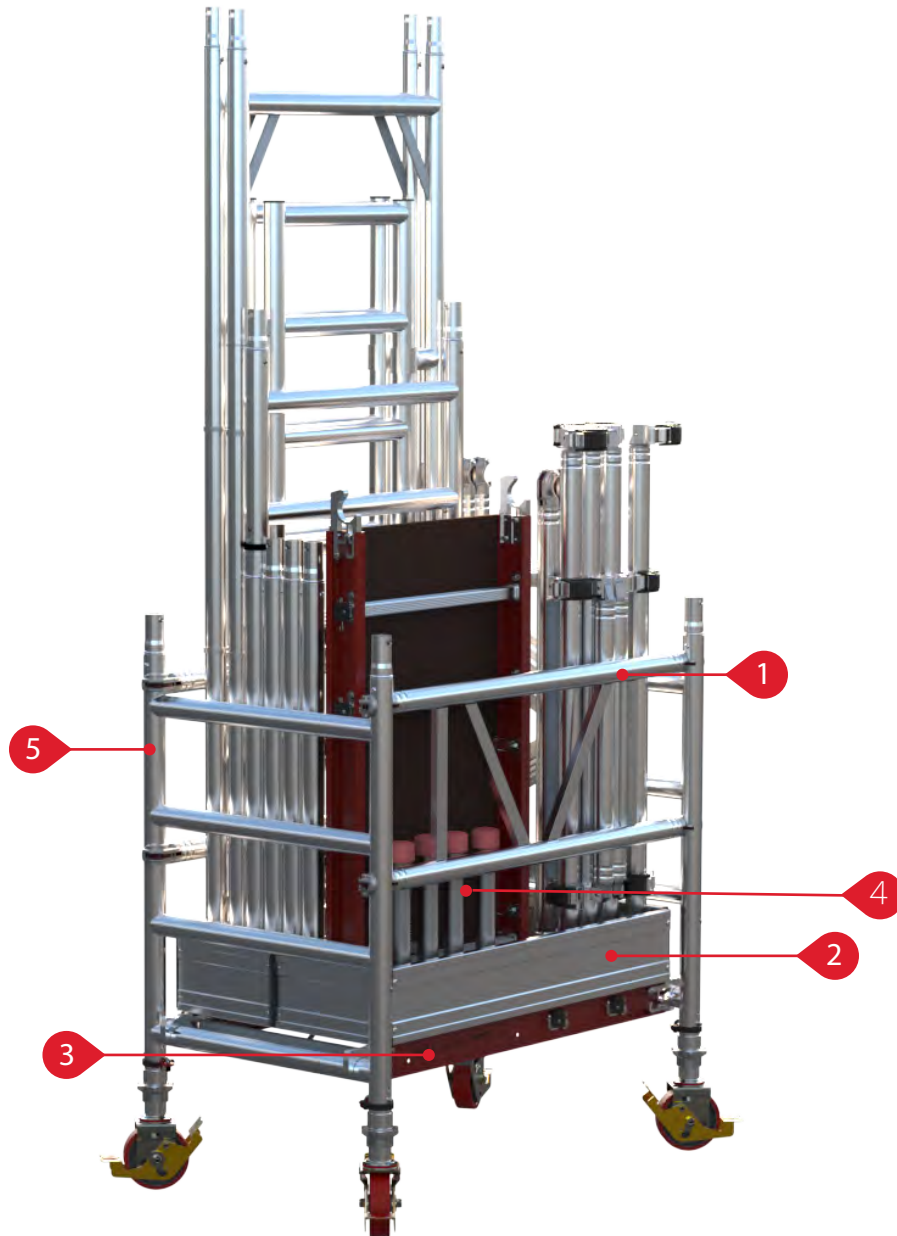

## TRANSPORT AND STORAGE

For ease of storage and of transportation, MI TOWER STAIRS has been designed so that all components can be safely stored within the tower's base assembly. Castors legs are an optional extra if you want to create a MI TOWER trolley for the stair pack. Castors can NOT be used when assembling MI TOWER STAIRS.

## TROLLEY COMPONENTS

- 1** GUARDRAIL BRACE PANEL X2
- 2** TOE BOARD SET
- 3** HATCH PLATFORM
- 4** ADJUSTABLE LEG AND CASTOR X4
- 5** 4 RUNG FRAME X2



## SAFETY DOS AND DON'TS - ALWAYS

- 1 Always read and understand this guide before you begin assembly.
- 2 Always ensure that all safety requirements are met and that MI TOWER STAIRS is the correct access solution for the task you wish to perform.
- 3 Always ensure that MI TOWER STAIRS is assembled and dismantled by a qualified, competent person.
- 4 Always cordon off the work area creating a zone with a radius that is 1m greater than the total height of MI TOWER STAIRS.
- 5 Always wear the correct Personal Protective Equipment for the task being performed. Gloves, steel toecap boots, a hard hat and suitable clothing must be worn by all persons.
- 6 Always tie back long hair and remove items of loose jewellery.
- 7 Always perform a full risk assessment prior to assembling or using MI TOWER STAIRS and abide by your findings.
- 8 Always prevent access to unauthorised persons if you have no other option but to leave MI TOWER unattended and if this is not possible then MI TOWER STAIRS must be dismantled.
- 9 Always make tools and materials required for the assembly of your MI TOWER STAIRS are made available on site.
- 10 Always ensure you properly assess the risk/method if tools or materials are hoisted to the platform via a rope.
- 11 Always access platforms from within MI TOWER STAIRS and via the 4 rung frames positioned at the platform's trap door end. Keep your feet in the middle of the rungs and grip the upper rungs with your hands.
- 12 Always erect MI TOWER STAIRS on smooth level ground that is capable of supporting its own weight, the user and any tools or materials without subsidence and free of obstructions.
- 13 Always use your MI TOWER STAIRS in accordance with the instructions contained within this assembly guide.
- 14 Always use your MI TOWER STAIRS in accordance with National Regulations.
- 15 Always remove persons and loose materials from your MI TOWER STAIRS before attempting to move it.

# SAFETY DOS AND DON'TS - NEVER

- 1 Never use MI TOWER STAIRS if you don't understand something in this guide; please contact the supplier for advice.
- 2 Never assemble, use, move or dismantle MI TOWER STAIRS if you are tired or unwell or if you are under the influence of alcohol or drugs.
- 3 Never use MI TOWER STAIRS in adverse weather conditions which may endanger the user.
- 4 Never use in wind conditions of Beaufort Force 5 and above. Please be aware of the tunnel effect caused by buildings close to each other. Dismantle the MI TOWER STAIRS if wind reaches Beaufort 6.
- 5 Never assemble or use MI TOWER STAIRS near overhead hazards such as power lines that are within reach of MI TOWER STAIRS or the user.
- 6 Never ascend or descend your MI TOWER STAIRS if both hands are not free.
- 7 Never add banners, notice boards, etc. to MI TOWER STAIRS or suspend weights from the tower.
- 8 Never use MITOWER STAIRS if contaminated by paint, chemicals, etc.
- 9 Never overload the platforms (see page 2 for details).
- 10 Never suspend MI TOWER STAIRS from another structure.
- 11 Never lean from MI TOWER STAIRS and never apply undue side force (max 200N)
- 12 Never stand on the guardrails, toe boards, boxes (or similar) to gain extra height. If the working height is insufficient either construct MI TOWER STAIRS to the required height or use an alternative method.
- 13 Never use damaged components in your MI TOWER STAIRS assembly.
- 14 Never use more than one working platform in your MI TOWER STAIRS.
- 15 Never allow more than one person on a working platform.
- 16 Never use MI TOWER STAIRS as a means to enter or exit other structures, or as a means of edge protection.
- 17 Never exceed a distance between platforms of 2.0m except for the first platform which can be 3.4m from the ground.
- 18 Never bridge between towers or other structures.
- 19 Never stand on an unguarded platform.
- 20 Never move the tower with people or materials on it.
- 21 Never lift the tower with mechanical equipment.
- 22 Never climb the outside of the tower.

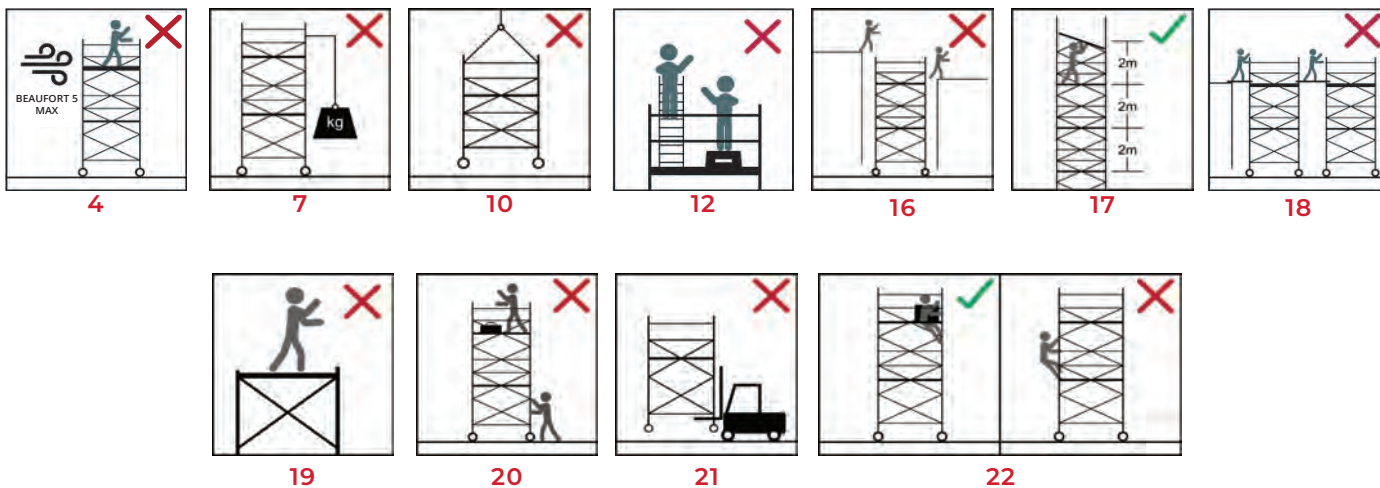

# BEFORE YOU START

## PREPARATION

The floor area must be clear of any obstructions including materials and debris. Check that you have all the components necessary to construct the tower height you require. Check also each component for condition and correct function. If any part is missing or damaged/not working correctly it must be replaced before assembling. Assess the height of tower required before attempting assembly. Refer to component matrices on page 6 for the correct component quantities and if required, ballast for the chosen platform height. Please note working height is generally calculated as two meters above platform height.

## 3T (THROUGH THE TRAPDOOR) SYSTEM

The 3T method of construction has been developed to reduce the risk of an erector falling from a tower during construction. The erector must sit on the platform with legs through the hatch and feet on the frame rungs when attaching guardrail brace panels above the platform. This ensures the erector is always protected by a set of guardrail brace panels.

## TYING IN

You should consider tying in the tower to add stability, but this may only be carried out by a suitably trained person.

## BALLAST

Where shown in the component matrices, ballast must be used to stabilise against overturning. Only use solid materials as ballast (i.e. no loose materials) and position to avoid overloading individual components. Ballast should be attached to the horizontal rungs of your MI TOWER STAIR and be either securely fastened or be of a design to prevent accidental removal. An example of such ballast is shown below. The quantity of ballast is shown in the component matrices on page 6.

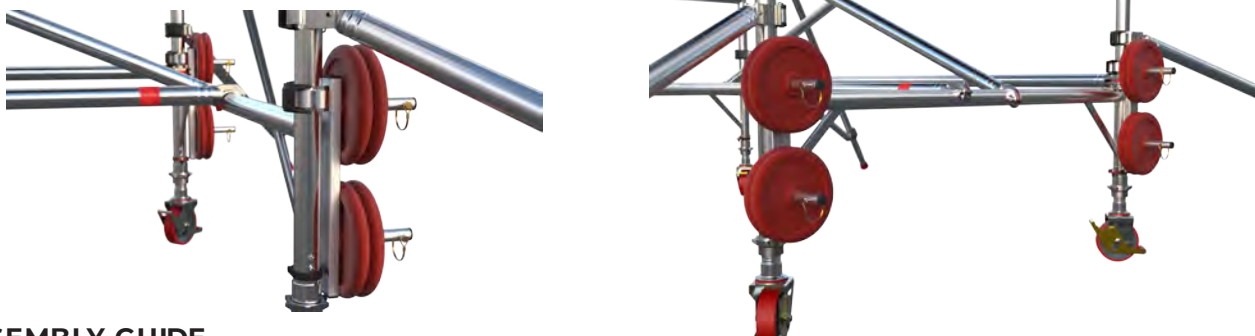

## ASSEMBLY GUIDE

These instructions must always be made available to the user. If replacement copies are required, please contact your supplier. This assembly guide is to be made available on the location of use of this MI TOWER STAIRS.

## DAMAGED COMPONENTS

Regularly inspect all components for damage. Damaged components must be quarantined so that they cannot be used. Where safe to do so, the component can be repaired but only by a qualified repairer. If in doubt contact your supplier for advice.

## DISMANTLING YOUR MI TOWER STAIRS

MI TOWER STAIR is easily dismantled by simply reversing the erection procedure. Make sure that the component hangers are evenly loaded to ensure your MI TOWER STAIRS remains balanced. You must, however, be protected by guardrail brace panels when standing on any platform and ensure that you use the 3T method when removing guardrail brace panels.

## AFTER ASSEMBLY

After assembly the following information needs to be displayed on the access tower and should be clearly visible from the ground (e.g. on a Scaffoldtag).

- The name & contact details of the responsible person
- If the tower is ready for application or not.
- The load class and Uniformly Distributed Load.
- If the access tower is intended for indoor use only.
- The date of assembly.

# GETTING STARTED

## GETTING STARTED

MI TOWER requires only one person to assemble and dismantle it. Your MI TOWER is supplied with uniform 1m high rung frames which can be used at any stage of the assembly. During erection, the frames may be connected together to create 2m high frames which makes assembly both quicker and easier.

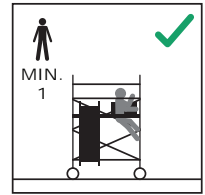

## STABILISERS POSITIONING

Stabilisers are supplied and must be used for all MI TOWER heights.

For maximum effect arrange the stabilisers by positioning at an angle of 45 degrees to give a footprint as close to square as possible as shown in fig.1.

If the tower is to be positioned against a wall, the stabiliser footprint can be altered as shown in fig 2 but only where the heights of the wall is a minimum of two thirds the height of the top working platform.

Ensure that all four stabilisers' feet are in contact with the ground and that the ground can support the weight of the tower and stabilisers.

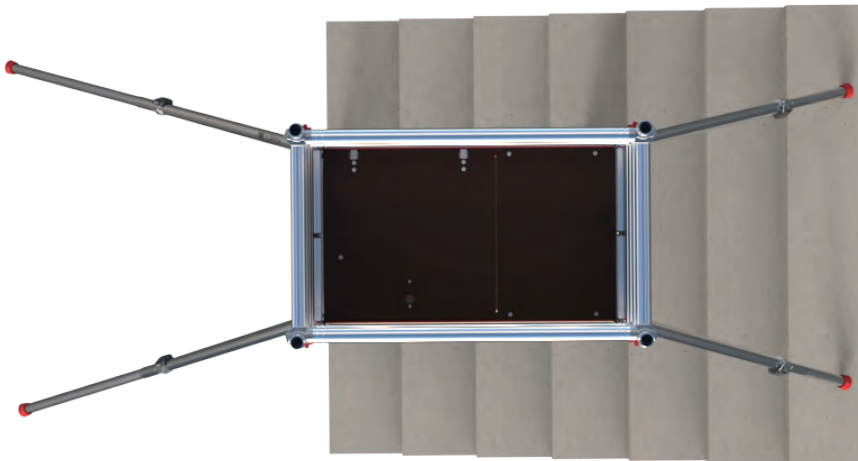

Fig. 1

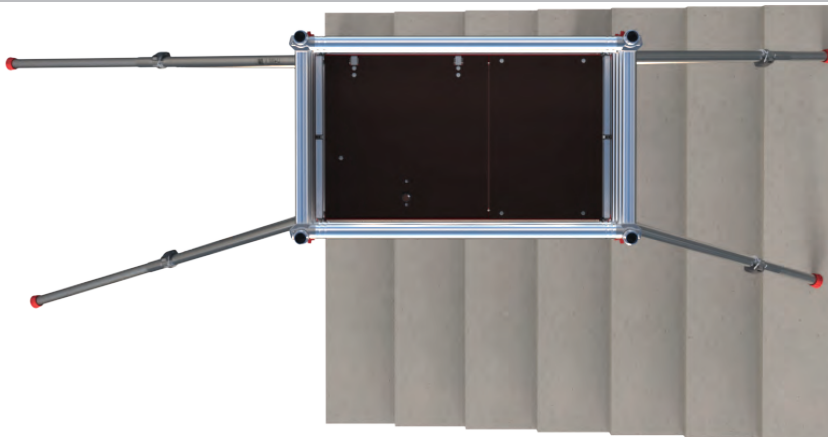
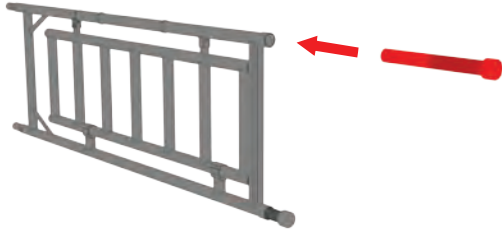

Fig. 2

# MI TOWER STAIRS 2.2m & 4.2m - ASSEMBLY



## STEP 1

Take four adjustable legs with rubber feet and insert two into the walk-through gate frame. Then insert the remaining two adjustable legs with rubber feet into the two rung frame. Adjust all leg height adjustment collars to bring all four legs to the lowest position.



## STEP 2

Construct the lowermost frame assembly. Release the Easy-Clip frame clips on one four rung frame. Take the lowermost walk-through gate frame and fit the four rung frame on top.

**Apply the Easy-Clip frame clips and ensure they are correctly locked.**



## STEP 3

Construct the uppermost frame assembly. Release the Easy-Clip frame clips on the two rung and two four rung frames. Take one four rung frame and fit it on top of the two rung frame. Take the second four rung frame and fit it on top of the first four rung frame.

**Apply all of the Easy-Clip frame clips and ensure they are correctly locked.**



## STEP 4

Place the walk-through frame assembly at the lowermost position of the staircase and attach the guardrail brace panel on the gate locking pin side of the frame ensuring its upper jaw is placed above the upper positioning ring.

**Ensure the two hooks are facing outwards and correctly locked on to the frame tube.**



## STEP 5

With your assistant holding the lowermost frame assembly and guardrail brace panel, place the uppermost frame assembly at the uppermost position of the staircase. Attach the guardrail brace panel to the vertical tube of the uppermost frame assembly. Ensure the upper brace hook is positioned above the third rung of the uppermost frame assembly.

**Make sure the hooks are correctly locked on the frame tube of the uppermost frame assembly.**

# MI TOWER STAIRS 2.2m & 4.2m - ASSEMBLY



## STEP 6

Attach another guardrail brace panel on the opposite side to the gate locking pin. Ensure the upper brace hook is positioned below the eighth rung of the lowermost frame assembly and sixth rung of the uppermost frame assembly.

Using the lower guardrail brace panel and a spirit level as a guide, adjust the lowermost legs to bring the Mi TOWER STAIRS square and level.

**Ensure all hooks are facing outwards and correctly locked on to the frame tubes.**



## STEP 7

Stand inside the Mi TOWER STAIRS and fit the platform on the sixth rung of the uppermost frame assembly, ensuring the trap door is positioned at the lowermost end of the Mi TOWER STAIRS.

**Make sure that the Wind-Lock catch engages correctly.**



## STEP 8

Fit an Easy-Lock stabiliser to each corner of the Mi TOWER STAIRS. The position of the upper and lower couplers will depend on the pitch of the staircase and position of any landings or floors. Ensure the stabiliser footprint is a square as possible within the confines of the staircase sides. Adjust each stabiliser's length so that each foot is in contact with the floor or step.

**Make sure all Easy-Lock clamps are correctly secured.**



## STEP 9

Open the walk-through gate and once in the Mi TOWER STAIRS close and secure it using the gate locking pin. Open the hatch door and using the rungs of the gate, climb until you are half way through the platform's trap door. Now manoeuvre yourself so that you are sitting on the platform, with your legs through the trap door and your feet resting on the rungs of the gate below the platform. From this position, you should take a guardrail brace panel, one at a time and attach so that the upper jaws are positioned above the tenth rung of the uppermost frame assembly. **Ensure all hooks are facing outwards and correctly locked on to the frame tubes.**

**If building a 4.2m platform height Mi TOWER STAIRS, follow step 10 onwards of the 4.7m platform height build. If building a 2.2m platform height Mi TOWER STAIRS proceed to step 10 of this build.**

## MI TOWER STAIRS 2.2m & 4.2m - ASSEMBLY

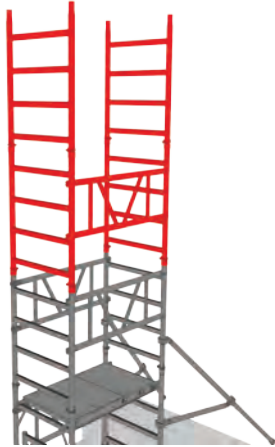

### STEP 10

Access the first platform and fit one set of conjoined frames to each end of the Mi TOWER STAIRS and apply the easy-lock frame clips. Next, attach a guardrail brace panel to the Mi TOWER STAIRS, with its lower jaw positioned above the fourteenth frame rung on the uppermost frame assembly.

**Ensure all claws are facing outward and correctly locked on to the frame tube.**



### STEP 11

Carefully fit the second platform on the sixteenth rung on the uppermost frame assembly.

**Make sure that the Wind-Lock catch is engaged.**



### STEP 12

Position yourself so that you are half way through the second platform's trap door. Now manoeuvre yourself so that you are sitting on the platform, with your legs through the trap door and your feet resting on the frame rungs. From this position, you should take each of the brace panels, one at a time and attach so that the upper jaws are positioned above the twentieth rung on the uppermost frame assembly.

**Ensure all claws are facing outward and correctly locked on to the frame tube.**



### STEP 13

With both panels in position, you may access the platform. Unfold the toe board set and position the toe board sections so that they sit over the outer edges of the platform. The Mi TOWER STAIRS is now complete and ready to use.

# MI TOWER STAIRS 2.7m & 4.7m - ASSEMBLY

## STEP 1

Fully insert the adjustable legs with rubber feet into two walk-through gate frames, turning the leg's height adjustment collar to bring all four legs to the lowest position.

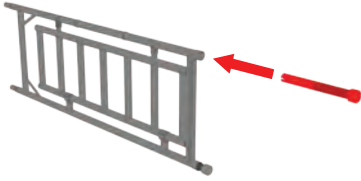

## STEP 2

Construct the lowermost frame assembly. Release the easy-clip frame clips on the two rung and one four rung frame. Take the lowermost walk-through gate frame and fit the two rung frame on top followed by the four rung frame.

**Apply the Easy-Clip frame clips and ensure they are correctly locked.**



## STEP 3

Construct the uppermost frame assembly. Release the easy-clip frame clips on one four rung frame. Take the uppermost walk-through gate frame and fit the four rung frame on top.

**Apply the Easy-Clip frame clips and ensure they are correctly locked.**



## STEP 4

Place the lowermost frame assembly at the lowermost position of the staircase and attach the guardrail brace panel on the gate locking pin side of the frame ensuring its upper hook is placed above the upper positioning ring.

**Ensure the two hooks are facing outwards and correctly locked on to the frame tube.**



## STEP 5

With your assistant holding the lowermost frame assembly and guardrail brace panel, place the uppermost frame assembly at the uppermost position of the staircase.

Attach the guardrail brace panel to the vertical tube of the uppermost frame assembly ensuring the upper brace hook is above the lower positioning ring.

**Make sure the hooks are correctly locked on the frame tube of the uppermost frame assembly.**





# MI TOWER STAIRS 2.7m & 4.7m - ASSEMBLY

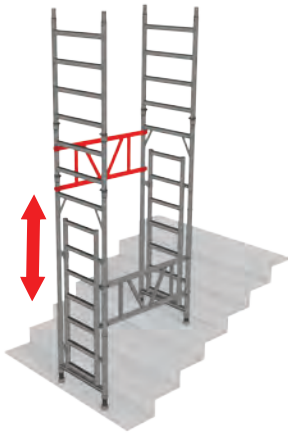

## STEP 6

Attach another guardrail brace panel on the opposite side to the gate locking pin. Ensure the upper brace hook is positioned below the tenth rung of the lowermost frame assembly and the eighth rung of the uppermost frame assembly.

It is easier to attach the guardrail brace panel by sliding it towards and then through the lowermost frame assembly before attaching the opposite hooks. Using the lower guardrail brace panel and a spirit level as a guide, adjust the lowermost legs to bring the Mi TOWER STAIRS square and level. Ensure all hooks are facing outwards and correctly locked on to the frame tubes.



## STEP 7

Stand inside the Mi TOWER STAIRS and fit the first platform on the eighth rung of the uppermost frame assembly, ensuring the trap door is positioned at the lowermost end of the Mi TOWER STAIRS. Make sure that the Wind-Lock catch engages correctly.

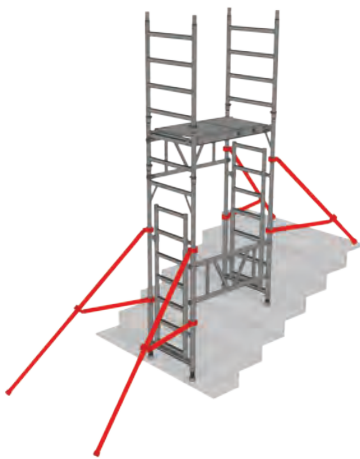

## STEP 8

Fit an easy-lock stabiliser to each corner of the Mi TOWER STAIRS. The position of the upper and lower couplers will depend on the pitch of the staircase and position of any landings or floors. Ensure the stabiliser footprint is as square as possible within the confines of the staircase sides. Adjust each stabilisers length so that each foot is in contact with the floor or step.

Make sure all Easy-Lock clamps are correctly secured.



## STEP 9

Open the lowermost walk-through gate and once in the Mi TOWER STAIRS close and secure it using the gate locking pin. Open the hatch door and using the rungs of the gate, climb until you are half way through the platform's trap door. Now manoeuvre yourself so that you are sitting on the platform, with your legs through the trap door and your feet resting on the rungs of the gate below the platform. From this position, you should take a guardrail brace panel, one at a time and attach so that the upper jaws are positioned above the twelfth rung of the uppermost frame assembly. Ensure all hooks are facing outwards and correctly locked on to the frame tubes.

At this step if building a 2.7m platform height Mi TOWER STAIRS, jump to step 13. Otherwise carry on from step 10.

## MI TOWER STAIRS 2.7m & 4.7m - ASSEMBLY

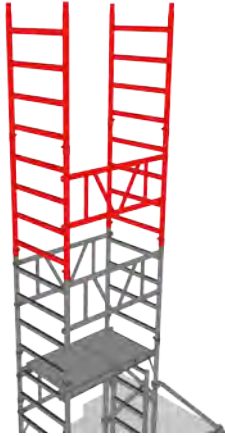

### STEP 10

Access the first platform and fit one set of conjoined frames to each end of the Mi TOWER STAIRS and apply the easy-lock frame clips. Next, attach a guardrail brace panel to the Mi TOWER STAIRS, with its lower jaw positioned above the fourteenth frame rung on the uppermost frame assembly.

**Ensure all claws are facing outward and correctly locked on to the frame tube.**



### STEP 11

Carefully fit the second platform on the sixteenth rung on the uppermost frame assembly.

**Make sure that the Wind-Lock catch is engaged.**



### STEP 12

Position yourself so that you are half way through the second platform's trap door. Now manoeuvre yourself so that you are sitting on the platform, with your legs through the trap door and your feet resting on the frame rungs. From this position, you should take each of the brace panels, one at a time and attach so that the upper jaws are positioned above the twentieth rung on the uppermost frame assembly.

**Ensure all claws are facing outward and correctly locked on to the frame tube.**



### STEP 13

With both panels in position, you may access the platform. Unfold the toe board set and position the toe board sections so that they sit over the outer edges of the platform. The Mi TOWER STAIRS is now complete and ready to use.

# 10 POINT PRE-USE SAFETY CHECKLIST

## 10 POINT PRE-USE CHECKLIST FOR USERS

<b>1</b>	<b>BEFORE USE</b>	Ensure tower is correct, complete and level.
<b>2</b>	<b>COMPONENTS</b>	Check all components are free from damage.
<b>3</b>	<b>LEGS &amp; FEET</b>	Ensure the feet are all level before building.
<b>4</b>	<b>ENVIRONMENT</b>	No environmental changes have influenced the safe use of your tower.
<b>5</b>	<b>STABILISER COUPLER CLAMPS</b>	Check they are secure & correctly attached.
<b>6</b>	<b>GUARDRAILS</b>	Make sure all platforms are fully enclosed by guardrails.
<b>7</b>	<b>BRACE CLAWS</b>	Check they are locked correctly.
<b>8</b>	<b>WINDLOCK CATCHES</b>	Make sure they are engaged.
<b>9</b>	<b>FRAME CLIPS</b>	Make sure they are engaged.
<b>10</b>	<b>TOE BOARDS</b>	Check they are correctly positioned on the platform.

**REGISTRATIONS**

**ISO 9001**

**EN 1004  
Class 3**





POP UP Products  
Unit E1, Tenth Avenue  
Deeside Industrial Park  
Deeside  
Flintshire  
CH5 2UA