

Leica TS03/TS07



User Manual
Version 1.0
English

- when it has to be **right**

Leica
Geosystems

Introduction

Purchase

Congratulations on the purchase of the Leica TS03/TS07.



This manual contains important safety directions as well as instructions for setting up the product and operating it. Refer to "1 Safety Directions" for further information.

Read carefully through the User Manual before you switch on the product.

Product identification

The model and serial number of your product are indicated on the type plate. Always refer to this information when you need to contact your agency or Leica Geosystems authorised service centre.

Trademarks

- Windows is a registered trademark of Microsoft Corporation in the United States and other countries
- *Bluetooth*[®] is a registered trademark of Bluetooth SIG, Inc.

All other trademarks are the property of their respective owners.

Validity of this manual

This manual applies to TS03 and TS07 instruments. Where there are differences between the various instruments they are clearly described.

For the Tunnel application, refer to the separate manual "Leica TS03/TS07 Tunnel Application".

For the Mining application, refer to the separate manual "Leica TS03/TS07 Mining Application".

Leica Geosystems address book

On the last page of this manual, you can find the address of Leica Geosystems headquarters. For a list of regional contacts, please visit http://leica-geosystems.com/contact-us/sales_support.



myWorld@Leica Geosystems (<https://myworld.leica-geosystems.com>) offers a wide range of services, information and training material.

With direct access to myWorld, you are able to access all relevant services whenever it is convenient for you.

Service	Description
myProducts	Add all products that you and your company own and explore your world of Leica Geosystems: View detailed information on your products and update your products with the latest software and keep up-to-date with the latest documentation.
myService	View the current service status and full service history of your products in Leica Geosystems service centres. Access detailed information on the services performed and download your latest calibration certificates and service reports.

Service	Description
mySupport	Create new support requests for your products that will be answered by your local Leica Geosystems Support Team. View the complete history of your support requests and view detailed information on each request in case you want to refer to previous support requests.
myTraining	Enhance your product knowledge with Leica Geosystems Campus - Information, Knowledge, Training. Study the latest online training material on your products and register for seminars or courses in your country.
myTrustedServices	Add your subscriptions and manage users for Leica Geosystems Trusted Services, the secure software services, that assist you to optimise your workflow and increase your efficiency.

Table of Contents

1	Safety Directions	8
1.1	General	8
1.2	Definition of Use	9
1.3	Limits of Use	9
1.4	Responsibilities	9
1.5	Hazards of Use	10
1.6	Laser Classification	13
1.6.1	General	13
1.6.2	Distancer, Measurements with Reflectors	14
1.6.3	Electronic Guide Light EGL	14
1.6.4	Laser Plummet	15
1.6.5	AutoHeight Laser Plummet	16
1.7	Electromagnetic Compatibility EMC	17
1.8	FCC Statement, Applicable in U.S.	18
1.9	ICES-003 Statement, Applicable in Canada	20
2	Description of the System	21
2.1	System Components	21
2.2	Container Contents	22
2.3	Instrument Components	23
3	User Interface	25
3.1	Keyboard	25
3.2	Screen	26
3.3	Status Icons	26
3.4	Icon Pop-up Bubbles	29
3.5	Softkeys	30
3.6	Operating Principles	31
3.7	Pointsearch	32
3.8	Graphic Symbols	33
4	Operation	35
4.1	Instrument Setup	35
4.2	Batteries	38
4.2.1	Operating Principles	38
4.2.2	Battery for the TS Instrument	39
4.3	Data Storage	39
4.4	Main Menu	40
4.5	Distance Measurements - Guidelines for Correct Results	42
5	Settings	44
5.1	Work Settings	44
5.2	Regional Settings	46
5.3	Data Settings	49
5.4	Screen & Audio Settings	50
5.5	EDM Settings	52
5.6	Interface Settings	57
5.7	FTP Client	58
5.8	Internet Settings	60
5.9	Adjust	61
5.10	Startup Sequence	62
5.11	System Information	62
5.12	Licence Keys	65
5.13	Instrument Protection with PIN	65
5.14	Loading Software	66

6	Apps - Getting Started	68
6.1	Overview	68
6.2	Starting an App	68
6.3	Setting the Job	69
6.4	Station Setup	70
7	Apps	72
7.1	Common Fields	72
7.2	Station Setup	72
	7.2.1 Starting	72
	7.2.2 Measuring the Target Points	75
	7.2.3 Station Setup Results	77
7.3	Surveying	80
7.4	Setout	80
7.5	Reference Line	84
	7.5.1 Overview	84
	7.5.2 Defining the Base Line	84
	7.5.3 Defining the Reference Line	85
	7.5.4 Measure Line & Offset	86
	7.5.5 Stakeout	87
	7.5.6 Grid Stakeout	89
	7.5.7 Line Segmentation	91
7.6	Reference Arc	94
	7.6.1 Overview	94
	7.6.2 Defining the Reference Arc	94
	7.6.3 Measure Line & Offset	96
	7.6.4 Stakeout	97
7.7	Reference Plane	100
7.8	Tie Distance	102
7.9	Area & DTM Volume	104
	7.9.1 Overview	104
	7.9.2 2D / 3D Area	106
	7.9.3 Area to Reference Plane	107
	7.9.4 DTM Volume	108
	7.9.5 Area Division	111
7.10	Remote Height	113
7.11	COGO	114
	7.11.1 Starting	114
	7.11.2 Inverse and Traverse	115
	7.11.3 Intersections	115
	7.11.4 Offsets	117
	7.11.5 Line - Extension	118
7.12	Road 2D	118
7.13	Road 3D	121
	7.13.1 Starting	121
	7.13.2 Basic Terms	122
	7.13.3 Creating or Uploading Alignment Files	126
	7.13.4 Stake	128
	7.13.5 Check	129
	7.13.6 Stake Slope	130
	7.13.7 Check Slope	133
7.14	Traverse	134
	7.14.1 Overview	134
	7.14.2 Starting and Configuring Traverse	135
	7.14.3 Measuring Traverse	137
	7.14.4 Moving ahead	139

	7.14.5	Closing a Traverse	140
	7.15	Tunnel	143
8	Favourites		144
	8.1	Overview	144
	8.2	Target Offset	145
		8.2.1 Overview	145
		8.2.2 Cylindrical Offset	146
	8.3	Hidden Point	148
	8.4	Check Tie	149
	8.5	EDM Tracking	150
	8.6	Backsight Check	151
	8.7	SketchPad	151
9	Coding		153
	9.1	Coding	153
	9.2	Quick Coding	154
10	MapView Interactive Display Feature		156
	10.1	Overview	156
	10.2	Accessing MapView	156
	10.3	Configuring MapView	156
	10.4	MapView Components	157
		10.4.1 Screen Area	157
		10.4.2 Keys, Softkeys and Toolbar	157
		10.4.3 Point Symbols	158
	10.5	Selecting Points	159
11	Imaging & Sketching		160
	11.1	Screenshot	160
	11.2	Sketching	160
	11.3	Image Management	161
12	Data Management		163
	12.1	Manage	163
	12.2	Exporting Data	164
	12.3	Importing Data	168
	12.4	Working with a USB Memory Stick	170
	12.5	Working with the SD Card	171
	12.6	Working with the Internal Memory	172
	12.7	Working with Bluetooth	173
	12.8	Working with the SIM Card	173
13	Check & Adjust		175
	13.1	Overview	175
	13.2	Preparation	175
	13.3	Adjusting Line-of-Sight and Vertical Index Error	176
	13.4	Adjusting the Compensator	178
	13.5	Adjusting the Tilting Axis Error	179
	13.6	Adjusting the Circular Level of the Instrument and Tribrach	180
	13.7	Adjusting the Circular Level of the Prism Pole	181
	13.8	Inspecting the Laser Plummet of the Instrument	181
	13.9	Servicing the Tripod	182
14	mySecurity		183
15	Care and Transport		185
	15.1	Transport	185
	15.2	Storage	185
	15.3	Cleaning and Drying	186

16	Technical Data	187
16.1	Angle Measurement	187
16.2	Distance Measurement with Reflectors	187
16.3	Distance Measurement without Reflectors (Non-Prism mode)	188
16.4	Distance Measurement Reflector (>4.0km)	189
16.5	Conformity to National Regulations	190
16.5.1	TS03	190
16.5.2	TS07	190
16.5.3	Dangerous Goods Regulations	191
16.6	General Technical Data of the Product	191
16.7	Scale Correction	195
16.8	Reduction Formulas	196
17	Software Licence Agreement	199
Appendix A	Menu Tree	200
Appendix B	Directory Structure	201

1 Safety Directions

1.1 General

Description

The following directions enable the person responsible for the product, and the person who actually uses the equipment, to anticipate and avoid operational hazards.

The person responsible for the product must ensure that all users understand these directions and adhere to them.

About warning messages





Warning messages are an essential part of the safety concept of the instrument. They appear wherever hazards or hazardous situations can occur.

Warning messages...

- make the user alert about direct and indirect hazards concerning the use of the product.
- contain general rules of behaviour.

For the users' safety, all safety instructions and safety messages shall be strictly observed and followed! Therefore, the manual must always be available to all persons performing any tasks described here.

DANGER, WARNING, CAUTION and **NOTICE** are standardised signal words for identifying levels of hazards and risks related to personal injury and property damage. For your safety, it is important to read and fully understand the following table with the different signal words and their definitions! Supplementary safety information symbols may be placed within a warning message as well as supplementary text.

Type	Description
 DANGER	Indicates an imminently hazardous situation which, if not avoided, will result in death or serious injury.
 WARNING	Indicates a potentially hazardous situation or an unintended use which, if not avoided, could result in death or serious injury.
 CAUTION	Indicates a potentially hazardous situation or an unintended use which, if not avoided, may result in minor or moderate injury.
NOTICE	Indicates a potentially hazardous situation or an unintended use which, if not avoided, may result in appreciable material, financial and environmental damage.
	Important paragraphs which must be adhered to in practice as they enable the product to be used in a technically correct and efficient manner.

1.2

Definition of Use

Intended use

- Measuring horizontal and vertical angles.
- Measuring distances.
- Recording measurements.
- Visualizing the aiming direction and vertical axis.
- Data communication with external appliances.
- Computing by means of software.

Reasonably foreseeable misuse

- Use of the product without instruction.
 - Use outside of the intended use and limits.
 - Disabling safety systems.
 - Removal of hazard notices.
 - Opening the product using tools, for example screwdriver, unless this is permitted for certain functions.
 - Modification or conversion of the product.
 - Use after misappropriation.
 - Use of products with recognisable damages or defects.
 - Use with accessories from other manufacturers without the prior explicit approval of Leica Geosystems.
 - Deliberate dazzling of third parties.
 - Controlling of machines, moving objects or similar monitoring application without additional control and safety installations.
 - Aiming directly into the sun.
 - Inadequate safeguards at the working site.
-

1.3

Limits of Use

Environment

Suitable for use in an atmosphere appropriate for permanent human habitation: not suitable for use in aggressive or explosive environments.

WARNING

Working in hazardous areas, or close to electrical installations or similar situations.

Life Risk.

Precautions:

- ▶ Local safety authorities and safety experts must be contacted by the person responsible for the product before working in such conditions.
-

1.4

Responsibilities

Manufacturer of the product

Leica Geosystems AG, CH-9435 Heerbrugg, hereinafter referred to as Leica Geosystems, is responsible for supplying the product, including the User Manual and original accessories, in a safe condition.

Person responsible for the product

The person responsible for the product has the following duties:

- To understand the safety instructions on the product and the instructions in the User Manual.
- To ensure that it is used in accordance with the instructions.
- To be familiar with local regulations relating to safety and accident prevention.
- To inform Leica Geosystems immediately if the product and the application becomes unsafe.
- To ensure that the national laws, regulations and conditions for the operation of the product are respected.

1.5

Hazards of Use

NOTICE

Dropping, misusing, modifying, storing the product for long periods or transporting the product

Watch out for erroneous measurement results.

Precautions:

- ▶ Periodically carry out test measurements and perform the field adjustments indicated in the User Manual, particularly after the product has been subjected to abnormal use as well as before and after important measurements.

DANGER

Risk of electrocution

Because of the risk of electrocution, it is dangerous to use poles, levelling staffs and extensions in the vicinity of electrical installations such as power cables or electrical railways.

Precautions:

- ▶ Keep at a safe distance from electrical installations. If it is essential to work in this environment, first contact the safety authorities responsible for the electrical installations and follow their instructions.



WARNING

Lightning strike

If the product is used with accessories, for example masts, staffs, poles, you may increase the risk of being struck by lightning.

Precautions:

- ▶ Do not use the product in a thunderstorm.

 **WARNING**

Distraction/loss of attention

During dynamic applications, for example stakeout procedures, there is a danger of accidents occurring if the user does not pay attention to the environmental conditions around, for example obstacles, excavations or traffic.

Precautions:

- ▶ The person responsible for the product must make all users fully aware of the existing dangers.

 **WARNING**

Inadequate securing of the working site.

This can lead to dangerous situations, for example in traffic, on building sites and at industrial installations.

Precautions:

- ▶ Always ensure that the working site is adequately secured.
- ▶ Adhere to the regulations governing safety, accident prevention and road traffic.

 **CAUTION**

Pointing product toward the sun

Be careful when pointing the product toward the sun, because the telescope functions as a magnifying glass and can injure your eyes and/or cause damage inside the product.

Precautions:

- ▶ Do not point the product directly at the sun.

 **CAUTION**

Not properly secured accessories.

If the accessories used with the product are not properly secured and the product is subjected to mechanical shock, for example blows or falling, the product may be damaged or people can sustain injury.

Precautions:

- ▶ When setting up the product, make sure that the accessories are correctly adapted, fitted, secured, and locked in position.
- ▶ Avoid subjecting the product to mechanical stress.

 **WARNING**

Inappropriate mechanical influences to batteries

During the transport, shipping or disposal of batteries it is possible for inappropriate mechanical influences to constitute a fire hazard.

Precautions:

- ▶ Before shipping the product or disposing it, discharge the batteries by the product until they are flat.
- ▶ When transporting or shipping batteries, the person in charge of the product must ensure that the applicable national and international rules and regulations are observed.
- ▶ Before transportation or shipping, contact your local passenger or freight transport company.

 **WARNING**

Exposure of batteries to high mechanical stress, high ambient temperatures or immersion into fluids

This can cause leakage, fire or explosion of the batteries.

Precautions:

- ▶ Protect the batteries from mechanical influences and high ambient temperatures. Do not drop or immerse batteries into fluids.

 **WARNING**

Short circuit of battery terminals

If battery terminals are short circuited e.g. by coming in contact with jewellery, keys, metallised paper or other metals, the battery can overheat and cause injury or fire, for example by storing or transporting in pockets.

Precautions:

- ▶ Make sure that the battery terminals do not come into contact with metallic objects.

WARNING

Improper disposal

If the product is improperly disposed of, the following can happen:

- If polymer parts are burnt, poisonous gases are produced which may impair health.
- If batteries are damaged or are heated strongly, they can explode and cause poisoning, burning, corrosion or environmental contamination.
- By disposing of the product irresponsibly you may enable unauthorised persons to use it in contravention of the regulations, exposing themselves and third parties to the risk of severe injury and rendering the environment liable to contamination.
- Improper disposal of silicone oil may cause environmental contamination.
- The product does include parts of Beryllium inside. Any modification of some internal parts can release Beryllium dust or fragments, creating a health hazard.

Precautions:

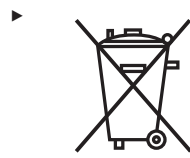

The product must not be disposed with household waste. Dispose of the product appropriately in accordance with the national regulations in force in your country. Always prevent access to the product by unauthorised personnel.

Product-specific treatment and waste management information can be received from your Leica Geosystems distributor.

WARNING

Improperly repaired equipment

Risk of injuries to users and equipment destruction due to lack of repair knowledge.

Precautions:

- ▶ Only authorised Leica Geosystems Service Centres are entitled to repair these products.

1.6

Laser Classification

1.6.1

General

General

The following chapters provide instructions and training information about laser safety according to international standard IEC 60825-1 (2014-05) and technical report IEC TR 60825-14 (2004-02). The information enables the person responsible for the product and the person who actually uses the equipment, to anticipate and avoid operational hazards.

- ☞ According to IEC TR 60825-14 (2004-02), products classified as laser class 1, class 2 and class 3R do not require:
 - laser safety officer involvement,
 - protective clothes and eyewear,
 - special warning signs in the laser working area
 if used and operated as defined in this User Manual due to the low eye hazard level.
- ☞ National laws and local regulations could impose more stringent instructions for the safe use of lasers than IEC 60825-1 (2014-05) and IEC TR 60825-14 (2004-02).

1.6.2

Distancer, Measurements with Reflectors

General

The EDM module built into the product produces a visible laser beam which emerges from the telescope objective.

The laser product described in this section is classified as laser class 1 in accordance with:

- IEC 60825-1 (2014-05): "Safety of laser products"

These products are safe under reasonably foreseeable conditions of operation and are not harmful to the eyes provided that the products are used and maintained in accordance with this User Manual.

Description	Value
Wavelength	658 nm
Pulse duration	800 ps
Pulse repetition frequency	100 MHz
Maximum average radiant power	0.34 mW
Beam divergence	1.5 mrad x 3 mrad

Labelling



a Laser beam

1.6.3

Electronic Guide Light EGL

General

The Electronic Guide Light built into the product produces a visible LED beam which emerges from the front side of the telescope.



The product described in this section, is excluded from the scope of IEC 60825-1 (2014-05): "Safety of laser products".
 The product described in this section, is classified as exempt group in accordance with IEC 62471 (2006-07) and does not pose any hazard provided that the product is used and maintained in accordance with this user manual.



0016427.001

- a LED beam red
- b LED beam yellow

1.6.4

Laser Plummet

General

The laser plummet built into the product produces a visible red laser beam which emerges from the bottom of the product.

The laser product described in this section is classified as laser class 2 in accordance with:

- IEC 60825-1 (2014-05): "Safety of laser products"

These products are safe for momentary exposures but can be hazardous for deliberate staring into the beam. The beam may cause dazzle, flash-blindness and after-images, particularly under low ambient light conditions.

Description	Value
Wavelength	640 nm
Maximum average radiant power	0.95 mW
Pulse duration	0.1 ms - cw
Pulse repetition frequency (PRF)	1 kHz
Beam divergance	< 1.5 mrad

CAUTION

Class 2 laser product

From a safety perspective, class 2 laser products are not inherently safe for the eyes.

Precautions:

- ▶ Avoid staring into the beam or viewing it through optical instruments.
- ▶ Avoid pointing the beam at other people or at animals.

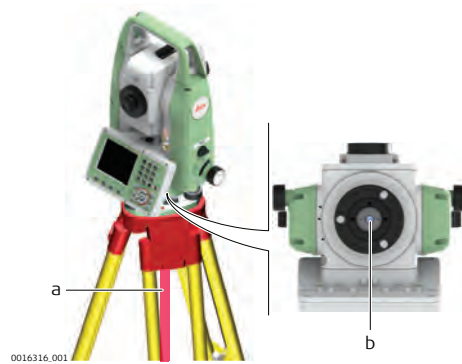

a Laser beam
b Exit for laser beam

1.6.5 AutoHeight Laser Plummet

General

The laser plummet built into the product produces a visible red laser beam which emerges from the bottom of the product.

The laser product described in this section is classified as laser class 2 in accordance with:

- IEC 60825-1 (2014-05): "Safety of laser products"

These products are safe for momentary exposures but can be hazardous for deliberate staring into the beam. The beam may cause dazzle, flash-blindness and after-images, particularly under low ambient light conditions.

Description	Value
Wavelength	640 nm
Maximum average radiant power	0.95 mW
Pulse duration	< 1 ns
Pulse repetition frequency (PRF)	320 MHz
Beam divergence	< 1.5 mrad

⚠ CAUTION

Class 2 laser product

From a safety perspective, class 2 laser products are not inherently safe for the eyes.

Precautions:

- ▶ Avoid staring into the beam or viewing it through optical instruments.
- ▶ Avoid pointing the beam at other people or at animals.

⚠ CAUTION

Class 2 laser product

Use of controls or adjustments or performance of procedures other than those specified herein may result in hazardous radiation exposure.

Precautions:

- ▶ Use controls or adjustments or performance of procedures only as specified.

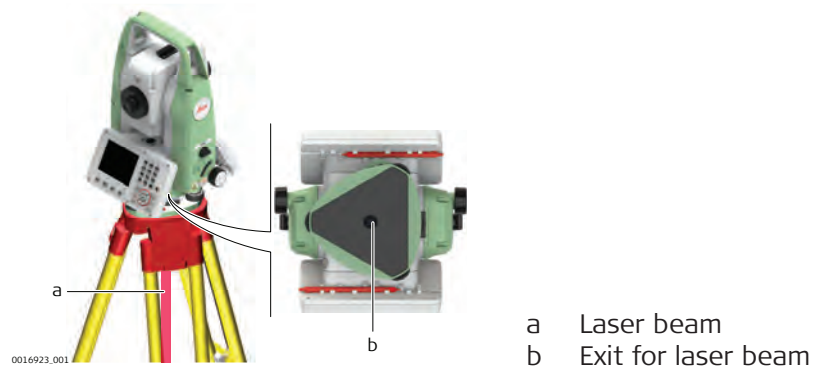

1.7

Electromagnetic Compatibility EMC

Description

The term Electromagnetic Compatibility is taken to mean the capability of the product to function smoothly in an environment where electromagnetic radiation and electrostatic discharges are present, and without causing electromagnetic disturbances to other equipment.

⚠ WARNING

Electromagnetic radiation

Electromagnetic radiation can cause disturbances in other equipment.

Precautions:

- ▶ Although the product meets the strict regulations and standards which are in force in this respect, Leica Geosystems cannot completely exclude the possibility that other equipment may be disturbed.

⚠ CAUTION

Use of the product with accessories from other manufacturers. For example field computers, personal computers or other electronic equipment, non-standard cables or external batteries

This may cause disturbances in other equipment.

Precautions:

- ▶ Use only the equipment and accessories recommended by Leica Geosystems.
- ▶ When combined with the product, they meet the strict requirements stipulated by the guidelines and standards.
- ▶ When using computers, two-way radios or other electronic equipment, pay attention to the information about electromagnetic compatibility provided by the manufacturer.

⚠ CAUTION

Intense electromagnetic radiation. For example, near radio transmitters, transponders, two-way radios or diesel generators

Although the product meets the strict regulations and standards which are in force in this respect, Leica Geosystems cannot completely exclude the possibility that function of the product may be disturbed in such an electromagnetic environment.

Precautions:

- ▶ Check the plausibility of results obtained under these conditions.

⚠ CAUTION

Electromagnetic radiation due to improper connection of cables

If the product is operated with connecting cables attached at only one of their two ends, for example external supply cables, interface cables, the permitted level of electromagnetic radiation may be exceeded and the correct functioning of other products may be impaired.

Precautions:

- ▶ While the product is in use, connecting cables, for example product to external battery, product to computer, must be connected at both ends.

Radios or digital cellular phones

⚠ WARNING

Use of product with radio or digital cellular phone devices:

Electromagnetic fields can cause disturbances in other equipment, in installations, in medical devices, for example pacemakers or hearing aids and in aircraft. It can also affect humans and animals.

Precautions:

- ▶ Although the product meets the strict regulations and standards which are in force in this respect, Leica Geosystems cannot completely exclude the possibility that other equipment can be disturbed or that humans or animals can be affected.
 - Do not operate the product with radio or digital cellular phone devices in the vicinity of filling stations or chemical installations, or in other areas where an explosion hazard exists.
 - Do not operate the product with radio or digital cellular phone devices near to medical equipment.
 - Do not operate the product with radio or digital cellular phone devices in aircraft.

1.8

FCC Statement, Applicable in U.S.



The greyed paragraph below is only applicable for products without radio.

⚠ WARNING

This equipment has been tested and found to comply with the limits for a Class B digital device, pursuant to part 15 of the FCC rules.

These limits are designed to provide reasonable protection against harmful interference in a residential installation.

This equipment generates, uses and can radiate radio frequency energy and, if not installed and used in accordance with the instructions, may cause harmful interference to radio communications. However, there is no guarantee that interference will not occur in a particular installation.

If this equipment does cause harmful interference to radio or television reception, which can be determined by turning the equipment off and on, the user is encouraged to try to correct the interference by one or more of the following measures:



- Reorient or relocate the receiving antenna.
- Increase the separation between the equipment and the receiver.
- Connect the equipment into an outlet on a circuit different from that to which the receiver is connected.
- Consult the dealer or an experienced radio/TV technician for help.

⚠ CAUTION

Changes or modifications not expressly approved by Leica Geosystems for compliance could void the user's authority to operate the equipment.

Labelling TS03/TS07

Model: TS0X **Art.No.:** 1 2 3 4 5 6
Equip.No.: 1234567
Power: $\cdot V$ \approx $\cdot V_{max}$ **S.No.:** 1 2 3 4 5 6
Leica Geosystems AG
CH-9435 Heerbrugg
Manufactured: 20XX
Made in Switzerland

Complies with FDA performance standards for laser products except for deviations pursuant to Laser Notice No. 50, dated June 24, 2007.
This device complies with part 15 of the FCC Rules.
Operation is subject to the following two conditions:
(1) This device may not cause harmful interference, and
(2) This device must accept any interference received, including interference that may cause undesired operation.

$P_{av} = 4.8mW$ $\lambda = 660nm$ $tp = 400ps$
IEC 60825-1:2014



0016315.001

Labelling GEB331

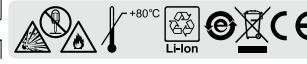

Type: GEB331 **Art.No.:** 799190
Li-Ion Battery **S.No.:** XXXXX
11.1V \approx / 2.8 Ah **Made in China**
 \approx 15 A / 31.1 Wh **Leica Geosystems AG, CH-9435 Heerbrugg**

This device complies with part 15 of the FCC Rules.
Operation is subject to the following two conditions:
(1) This device may not cause harmful interference, and
(2) This device must accept any interference received, including interference that may cause undesired operation.

 **11WE**
MH29443

0008469.006

Labelling GEB361

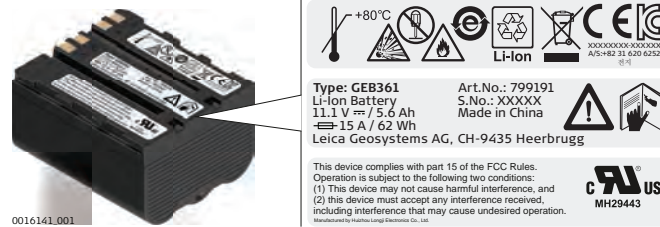

1.9

ICES-003 Statement, Applicable in Canada

WARNING

This Class (B) digital apparatus complies with Canadian ICES-003.
Cet appareil numérique de la classe (B) est conforme à la norme NMB-003 du Canada.

Canada Compliance Statement

This device complies with Industry Canada's license-exempt RSSs. Operation is subject to the following two conditions:

1. This device may not cause interference; and
2. This device must accept any interference, including interference that may cause undesired operation of the device.

Canada Déclaration de Conformité

Le présent appareil est conforme aux CNR d'Industrie Canada applicables aux appareils radio exempts de licence. L'exploitation est autorisée aux deux conditions suivantes:

1. l'appareil ne doit pas produire de brouillage;
2. l'appareil doit accepter tout brouillage radioélectrique subi, même si le brouillage est susceptible d'en compromettre le fonctionnement.

2

Description of the System

2.1

System Components

Main components

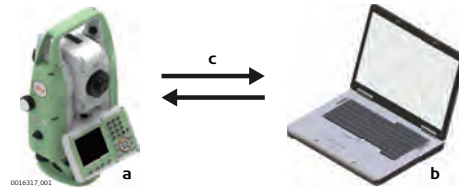

- a TS03/TS07 instrument with FlexField firmware
- b Computer with Leica Infinity software
- c Data transfer

Component	Description
TS03/TS07	<p>An instrument for measuring, calculating and capturing data. Ideally suited for tasks from simple surveys to complex applications. Equipped with a FlexField firmware package to complete these tasks.</p> <p>The various lines have a range of accuracy classes and support different features. All lines can be connected with Leica Infinity to view, exchange and manage data.</p>
FlexField firmware	<p>The firmware package installed on the instrument. Consists of a standard base operating system with optional additional features.</p>
Leica Infinity software	<p>An office software consisting of a suite of standard and extended programs for the viewing, exchanging, managing and post processing of data.</p>
Data transfer	<p>Data can be transferred between a TS03/TS07 and a computer via USB cable, USB-stick, SD card and data transfer cable.</p>

2.2

Container Contents

Container contents part 1 of 2

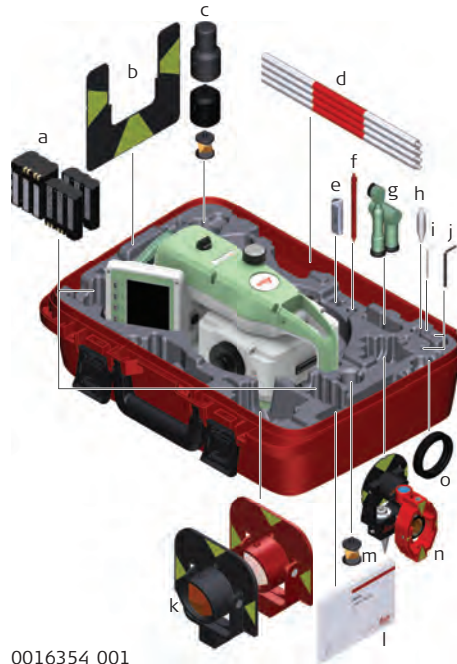

0016354_001

- a GEB331 or GEB361 battery
- b GZT4 target plate
- c GRZ101 mini prism, GAD103 and GAD105 adapter
- d GLS115 mini prism pole
- e Leica industrial grade USB memory stick
- f Stylus**
- g GFZ3 and GOK6 diagonal eyepiece*
- h Tip for mini prism
- i Adjustment tool
- j Allen key
- k GPR111 and GPR121 round prism
- l Manuals
- m GRZ101 360° mini prism
- n GMP101 and GMP111 mini prism*
- o Counterweight for diagonal eyepiece*

* Optional

** For TS07

**Container contents
part 2 of 2**



0016355_001

- a SD card
- b CPR105 flat prism*
- c GHT196 holder for height metre*
- d GHM007 height metre*
- e GLI115 clip-on bubble*
- f GKL311 charger
- g Protective cover / Lens hood / Cleaning cloth
- h Data cable

* Optional

2.3 Instrument Components

**TS03
Instrument
components
part 1 of 2**



- a Compartment for SD card, USB memory stick and USB cable ports
- b Optical sight
- c Detachable carrying handle with mounting screw
- d Objective with integrated Electronic Distance Measurement (EDM). Exit for EDM laser beam
- e Vertical drive
- f Loudspeaker
- g Trigger key
- h Serial interface RS232, located behind keyboard on rotation part
- i Horizontal drive

**TS03
Instrument
components
part 2 of 2**



- j Focusing telescope image
- k Eyepiece; focusing graticule
- l Battery cover
- m Foot screw
- n Keyboard with display

**TS07
Instrument
components
part 1 of 2**



- a Compartment for SD card, USB memory stick and USB cable ports
- b Optical sight
- c Detachable carrying handle with mounting screw
- d Electronic Guide Light (EGL)*
- e Objective with integrated Electronic Distance Measurement (EDM). Exit for EDM laser beam
- f Vertical drive
- g Loudspeaker
- h Trigger key
- i Serial interface RS232, located behind keyboard on rotation part
- j Horizontal drive
- k Keyboard with display

* Optional

**TS07
Instrument
components
part 2 of 2**



- l LTE antenna*
- m Focusing telescope image
- n Eyepiece; focusing graticule
- o Battery cover
- p Foot screw
- q Stylus
- r Keyboard with display

* Optional

3

User Interface

3.1

Keyboard

Keyboard

TS03 with Greyscale display

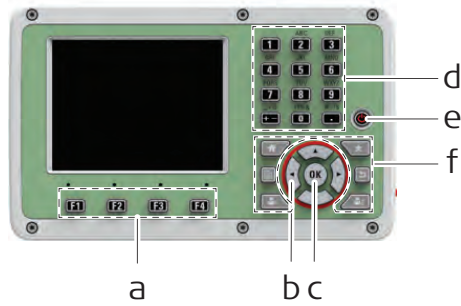

0016323.001



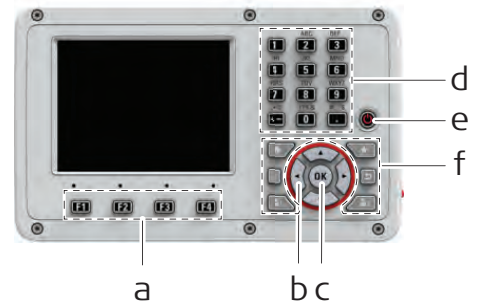





TS07 with Color&Touch display





0016322.001

- a Function keys **F1** to **F4**
- b Navigation keys
- c **ENTER** key
- d Alphanumeric keypad
- e **ON/OFF** key
- f Fixed keys

Keys

Key	Description
	If the instrument is already off: Turns on the instrument when held for 2 s. If the instrument is already on: Turns to Power Options menu when held for 2 s.
	Page key Displays the next screen when several screens are available.
	Favourites key Quick-access to measurement supporting functions.
	User key 1 Programmable with a function from the Favourites menu.
	User key 2 Programmable with a function from the Favourites menu.
	Navigation key Controls the focus bar within the screen and the entry bar within a field.
	ENTER key Confirms an entry and continues to the next field.
	Pressing ESC short: Returns to next higher level. Quits a screen or edit mode without saving changes. Pressing ESC long: Returns to the Main Menu . Quits a screen or edit mode without saving changes.
	Home key Returns to the main menu.

Key	Description
	Function keys that are assigned the variable functions displayed at the bottom of the screen.
	Alphanumeric keypad for entry of text and numerical values.

Sidecover keys

Key	Description
	Trigger key. Quick key programmable with functions Meas , Dist or Store if desired. The trigger key can be programmed in the Settings screen. Refer to "5.1 Work Settings".

3.2

Screen

Screen

The TS03 is available with Greyscale (G) screen.

The TS07 is available with Color&Touch (C&T) screen.

The look and feel is the same for both types.



All screens shown in this manual are examples. It is possible that local firmware versions are different to the basic version.

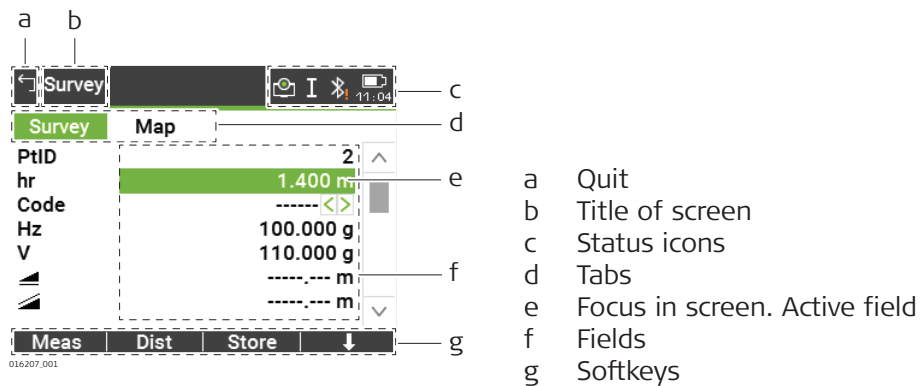

Tap on an icon, field or tab to run a function.





3.3





















Status Icons

Description









The icons provide status information related to basic instrument functions. Depending on the display type, different icons are displayed.

Icons

Icon	Description
	Non-prism EDM mode for measuring to all targets. For TS07: Tapping the icon opens the EDM & Target bubble.
	Leica standard prism is selected. For TS07: Tapping the icon opens the EDM & Target bubble.
	Leica mini prism is selected. For TS07: Tapping the icon opens the EDM & Target bubble.
	Leica mini 0 prism is selected. For TS07: Tapping the icon opens the EDM & Target bubble.

Icon	Description
	Leica sliding basic mini prism is selected. For TS07: Tapping the icon opens the EDM & Target bubble.
	Leica 360° prism is selected. For TS07: Tapping the icon opens the EDM & Target bubble.
	Leica 360° mini prism is selected. For TS07: Tapping the icon opens the EDM & Target bubble.
	Leica 360° MPR122 prism is selected. For TS07: Tapping the icon opens the EDM & Target bubble.
	Leica reflector tape is selected. For TS07: Tapping the icon opens the EDM & Target bubble.
	User defined prism is selected. For TS07: Tapping the icon opens the EDM & Target bubble.
	
	A running vertical line left beside the prism indicates EDM measurement activity.
	Indicates an active laser pointer. For TS07: Tapping the icon opens the EDM & Target bubble.
	Indicates that Meas. Mode: Average is active.
	Indicates that Meas. Mode: Prism (>4.0km) is active.
	Indicates that Meas. Mode: Precise&Fast is active.
	Indicates that Meas. Mode: Tracking is active.
	Indicates telescope position in face I. For TS07: Tapping the icon opens the Instrument bubble.
	Indicates telescope position in face II. For TS07: Tapping the icon opens the Instrument bubble.
	Compensator is on. For TS07: Tapping the icon opens the Instrument bubble.
	
	Compensator is off. For TS07: Tapping the icon opens the Level & Plummet screen.
	Compensator is out of range. For TS07: Tapping the icon opens the Level & Plummet screen.
	Bluetooth configured and paired

	Bluetooth	RS232	LTE
Selected	✓	-	-
Active	✓	-	-

Icon	Description			
	For TS07: Tapping the icon opens the Connectivity bubble. Click on Interface settings to open the Interface Settings screen.			
	Bluetooth configured but not paired			
		Bluetooth	RS232	LTE
Selected		✓	-	-
Active		-	-	-
	Modem configured and connected with the Internet			
		Bluetooth	RS232	LTE
Selected		-	-	✓
Active		-	-	✓
	Modem configured but not connected with the Internet			
		Bluetooth	RS232	LTE
Selected		-	-	✓
Active		-	-	-
	Bluetooth configured but not paired. Modem configured but not connected with the Internet			
		Bluetooth	RS232	LTE
Selected		✓	-	✓
Active		-	-	-
	Bluetooth configured and paired. Modem configured but not connected with the Internet			
		Bluetooth	RS232	LTE
Selected		✓	-	✓
Active		✓	-	-
	Bluetooth configured but not paired. Modem configured and connected with the Internet			
		Bluetooth	RS232	LTE
Selected		✓	-	✓
Active		-	-	✓
	Bluetooth configured and paired. Modem configured and connected with the Internet			
		Bluetooth	RS232	LTE
Selected		✓	-	✓
Active		✓	-	✓
	RS232 configured and connected			
		Bluetooth	RS232	LTE
Selected		-	✓	-
Active		-	✓	-

Icon	Description			
	RS232 configured and connected Modem configured and connected with the Internet			
		Bluetooth	RS232	LTE
	Selected	-	✓	✓
	Active	-	✓	✓
	RS232 configured and connected Modem configured but not connected with the Internet			
		Bluetooth	RS232	LTE
	Selected	-	✓	✓
	Active	-	✓	-
<p>The battery symbol indicates the level of the remaining battery capacity. For TS07: Tapping the icon opens a bubble showing the status of the battery and the internal memory.</p>				
	Battery level is 100% full.			
	Battery level is critical.			

3.4

Icon Pop-up Bubbles

Description

Status information helps using the instrument by showing the state of many instrument functions. All fields are display only fields. Unavailable information is indicated by ---.

Frequently used functionality can be accessed and changed quickly. The change is applied immediately. The workflow is not interrupted.

Access

Tap a status icon in the icon area. An icon pop-up bubble opens.

An icon pop-up bubble shows:

- Status information
- Functionality related to the icon which was tapped

Tap a bubble icon to use the functionality.

To close an icon pop-up bubble, touch the screen anywhere outside of the icon pop-up bubble.

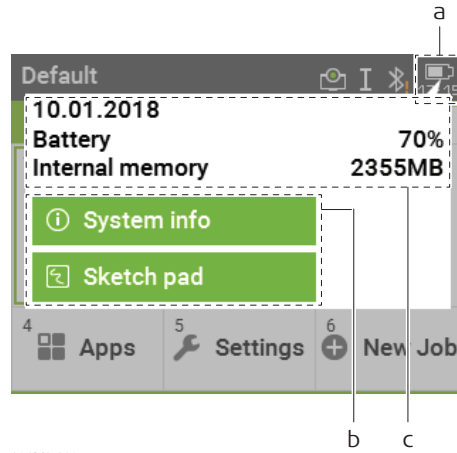

014962_001_en

- a Status icon
- b Status information
- c Bubble icon

Description of the icon pop-up bubbles

Refer to the individual chapters for more information.

EDM & Target

Status Information	Functionality
<ul style="list-style-type: none"> • Current target with defined constants • Type of distance measurement 	<ul style="list-style-type: none"> • Switch between non-prism and prism mode • Turn the red laser of the reflectorless EDM on/off • Select targets

Instrument

Status Information	Functionality
<ul style="list-style-type: none"> • Current setup ID, instrument height and level status 	<ul style="list-style-type: none"> • Electronic level bubble and compensator settings

Connectivity

Status Information	Functionality
<ul style="list-style-type: none"> • Current interface setting 	<ul style="list-style-type: none"> • Start Interface Settings

Battery and date

Status Information	Functionality
<ul style="list-style-type: none"> • Date • Remaining power capacity for the battery • Active internal memory 	<ul style="list-style-type: none"> • View the system information • Create a sketch on a virtual piece of paper

3.5

Softkeys

Description

Softkeys are selected using the relevant **F1** to **F4** function key. This chapter describes the functionality of the common softkeys used by the system. The more specialised softkeys are described with the apps where they appear.

Common softkey functions

Key	Description
Cont	If entry screen: Confirms measured or entered values and continues the process. If message screen: Confirms message and continues with selected action or returns to the previous screen to reselect an option.
Back	To return to the last active screen.
Default	To reset all editable fields to their default values.
Dist	To start distance and angle measurements without saving the measured values.
EDM	To view and change EDM settings. Refer to "5.5 EDM Settings".
New	To open the manual coordinate entry screen.
Find	To search for an entered point.
List	To display the list of available points.
Meas	To start distance and angle measurements and save the measured values.
Exit	To exit the screen or app.
Store	To save the displayed values.
View	To display the coordinate and job details of the selected point.
-> ABC	To change the keypad operation to alphanumerical.
-> 345	To change the keypad operation to numerical.
↓	To display the next softkey level.
↑	To return to the first softkey level.

3.6

Operating Principles

Turn instrument on/off

Button	Description
	To turn the instrument on or off, use the On/Off key on the keyboard of the instrument. Press the key for 2 seconds to display the Power Options menu.

Selection of language





After switching on the instrument the user is able to choose their preferred language. The language choice screen is only shown if multiple languages are loaded onto the instrument and **Lang.Choice: On** is set in the instrument settings. Refer to "5.2 Regional Settings".

Alphanumeric keypad

The alphanumerical keypad is used to enter characters directly into editable fields.

- **Numeric fields:** Can only contain numerical values. By pressing a key of the keypad the number will be displayed.
- **Alphanumeric fields:** Can contain numbers and letters. By pressing a key of the keypad the first character written above that key will be displayed. By pressing several times you can toggle through the characters. For example: 1- >S- >T- >U- >1- >S....
When the alphanumeric mode is active, numbers are not selectable. For example: T= >U= > V= >T....

Edit fields

Button	Description
	ESC Deletes any change and restores the previous value.
	Moves the cursor to the left
	Moves the cursor to the right.
	Inserts a character at the cursor position.
	Deletes the character at the cursor position.



In edit mode the position of the decimal place cannot be changed. The decimal place is skipped.

Special characters

Character	Description
*	Used as wildcards in search fields for point numbers or codes. Refer to "3.7 Pointsearch".
+/-	In the alphanumeric character set "+" and "-" are treated as normal alphanumeric characters with no mathematical function.

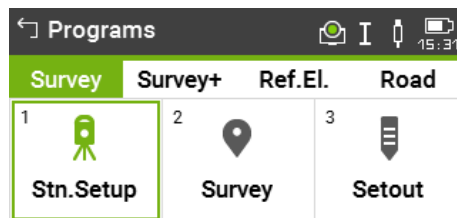

In this example selecting 2 on an alphanumeric keyboard would start the Survey app.

3.7

Pointsearch

Description

Pointsearch is a function to find measured points or fixpoints in the memory storage.

It is possible to limit the point search to a particular job or to search the whole storage. The search procedure always finds fixpoints before measured points that fulfil the same search criteria. If several points meet the search criteria, then the results are ordered according to the entry date. The instrument finds the most recent fixpoint first.

Direct search

By entering an actual point number, for example 402, and pressing **Find**, all points within the selected job and with the corresponding point number are found.

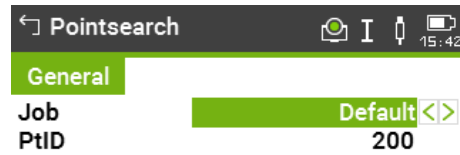

Select job or enter
point coordinates manually!



Key	Description
Find	To search for matching points within the selected job.
ENH=0	To set all ENH coordinates for the point ID to 0.

Wildcard search

The wildcard search is indicated by a "*". The asterisk is a place holder for any following sequence of characters. Wildcards should be used if the point number is not fully known, or to search for a batch of points.

Examples of point searches

*	All points are found.
A	All points with exactly the point number "A" are found.
A*	All points starting with "A" are found, for example, A9, A15, ABCD, A2A.
*1	All points containing only one "1" are found, for example, 1, A1, AB1.
A*1	All points starting with "A" and containing only one "1" are found, for example, A1, AB1, A51.









3.8













Graphic Symbols

Graphic symbols

In some apps, a graphical display is shown. The graphical display

- provides a guide to find the point to be staked out.
- allows for a better overall understanding of how the data being used and measured relates to each other.

Element	Description
	Point to be staked / known point
	Instrument
	Current position of prism (measurement with Dist)
 	Forward/backwards distance to point
 	Side distance to point
 	Height distance to point

Element	Description
	The stakeout point is the same as the measured point. The difference between stakeout point and measured point is ≤ 0.03 m.
	Circle around the stake out point, supporting the detail view, radius = 0.5 m
	Fixpoint
	Fixpoint active
	Station
	Station active
	Centre point of an arc or circle
	Measured point
	Measured point active
	Black squares around the point symbol indicate the plane points.
	Connection between last measured/selected point and first point of an area
	Breaklines of an area

4

Operation

4.1

Instrument Setup

Description

This topic describes an instrument setup over a marked ground point using the laser plummet. It is always possible to set up the instrument without the need for a marked ground point.



Important features

- It is always recommended to shield the instrument from direct sunlight and avoid uneven temperatures around the instrument.
- The laser plummet described in this topic is built into the vertical axis of the instrument. It projects a red spot onto the ground, making it appreciably easier to centre the instrument.
- The laser plummet cannot be used with a tribrach equipped with an optical plummet.

Tripod

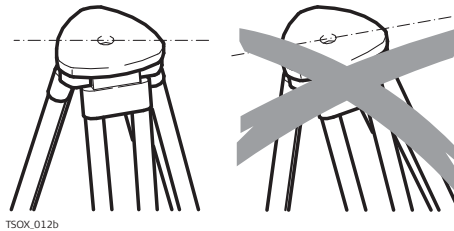

TSOX_012b

When setting up the tripod pay attention to ensuring a horizontal position of the tripod plate. Slight corrections of inclination can be made with the foot screws of the tribrach. Larger corrections must be done with the tripod legs.

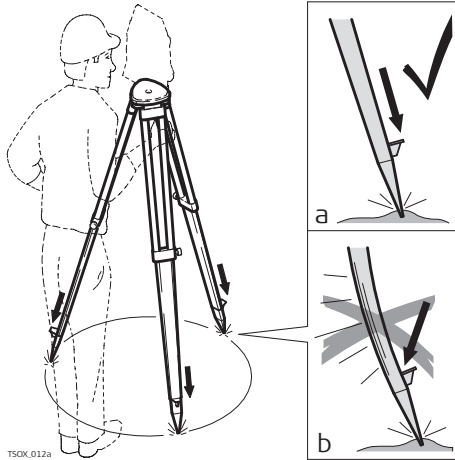

TSOX_012a

Loosen the clamping screws on the tripod legs, pull out to the required length and tighten the clamps.

- In order to guarantee a firm foothold sufficiently press the tripod legs into the ground.
- When pressing the legs into the ground note that the force must be applied along the legs.

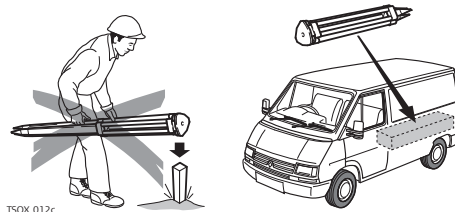



TSOX_012c

Careful handling of tripod.

- Check all screws and bolts for correct fit.
- During transport, always use the cover supplied.
- Use the tripod only for surveying tasks.

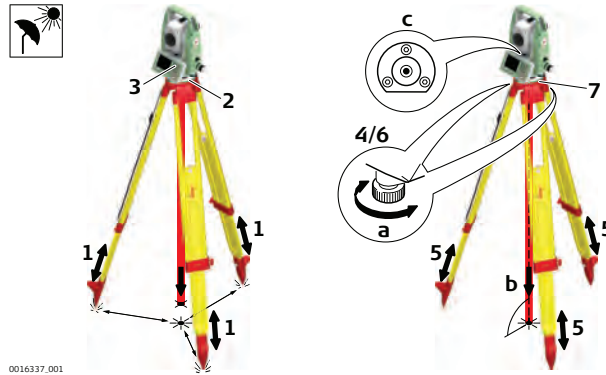
Setup step-by-step



1. Extend the tripod legs to allow for a comfortable working posture. Position the tripod over the marked ground point, centring it as best as possible.
2. Fasten the tribrach and instrument onto the tripod.
3. Turn on the instrument, and, if tilt correction is set to **On**, the laser plummet will be activated automatically, and the **Level & Plummet** screen appears. Otherwise, press the  key from within any app and select **Level & Plummet**.
 For TS07, use the optional AutoHeight laser plummet for vertically setting up the instrument over a ground point and for measuring the instrument height when setting up the station.
4. Move the tripod legs and use the tribrach footscrews (a) to centre the plummet over the ground point (c).
5. Adjust the tripod legs to level the circular level (c).
6. By using the electronic level, turn the tribrach footscrews to precisely level the instrument. Refer to "Level up with the electronic level step-by-step".
7. Centre the instrument precisely over the ground point by shifting the tribrach on the tripod plate .
8. Repeat steps 6. and 7. until the required accuracy is achieved.

Level up with the electronic level step-by-step

The electronic level can be used to precisely level up the instrument using the footscrews of the tribrach.

1. Turn the instrument until it is parallel to two footscrews.
2. Centre the circular level approximately by turning the footscrews of the tribrach.

- Turn on the instrument, and, if tilt correction is set to On, the laser plummet will be activated automatically, and the **Level & Plummet** screen appears. Otherwise, press the Favourites key from within any app and select **Level & Plummet**.

☞ For TS07, use the optional AutoHeight laser plummet for vertically setting up the instrument over a ground point and for measuring the instrument height when setting up the station.

☞ The bubble of the electronic level and the arrows for the rotating direction of the footscrews only appear if the instrument tilt is inside a certain levelling range.

- Centre the electronic level of the first axis by turning the two footscrews. Arrows show the direction of rotation required. The first axis is levelled, when the bubble is exactly between the squared brackets [] of the single axis bubble tube.

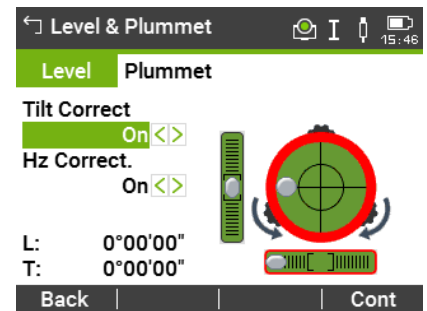

☞ When levelled correctly, checkmarks are displayed. For the Color and Color&Touch screens: If the instrument is not levelled to one axis, then the icons for the single axis bubble tube and the circular bubble are framed red, else they are black.

- Centre the electronic level for the second axis by turning the last footscrew. An arrow shows the direction of rotation required.

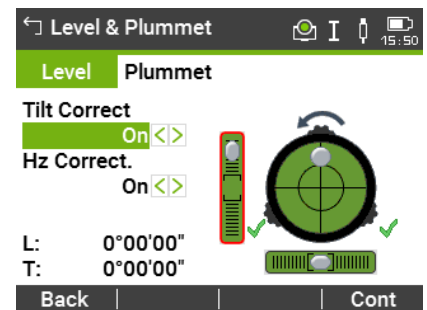

When all three bubbles are centred, the instrument has been perfectly levelled up.

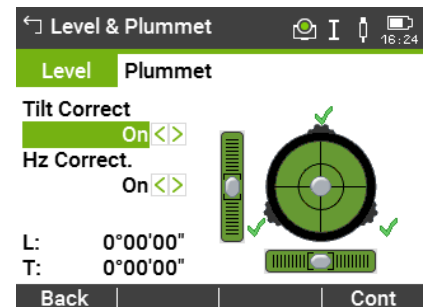

- Accept with **Cont**.

Change the intensity of the laser plummet

External influences and the surface conditions may require the adjustment of the intensity of the laser plummet.

In the **Level & Plummet** screen, adjust the intensity of the laser plummet using the navigation key.

The laser can be adjusted in 20% steps as required.

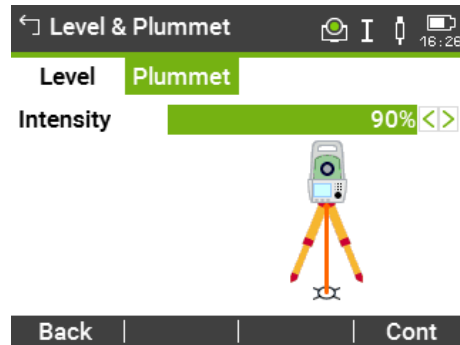

Position over pipes or holes

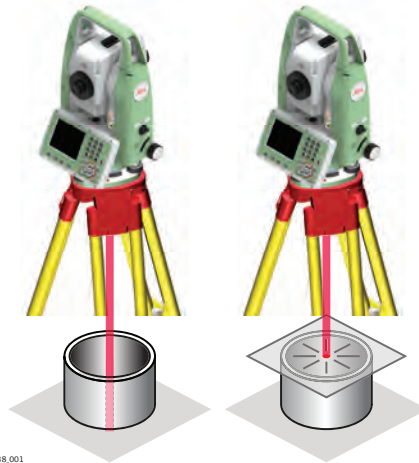

Under some circumstances the laser dot is not visible, for example over pipes. In this case, using a transparent plate enables the laser dot to be seen and then easily aligned to the centre of the pipe.

4.2

Batteries

4.2.1

Operating Principles

First-time use/ charging batteries

- The battery must be charged before using it for the first time because it is delivered with an energy content as low as possible.
- The permissible temperature range for charging is from 0 °C to +40 °C / +32 °F to +104 °F. For optimal charging, we recommend charging the batteries at a low ambient temperature of +10 °C to +20 °C / +50 °F to +68 °F if possible.
- It is normal for the battery to become warm during charging. Using the chargers recommended by Leica Geosystems, it is not possible to charge the battery once the temperature is too high.
- For new batteries or batteries that have been stored for a long time (> three months), it is effectual to make only one charge/discharge cycle.
- For Li-Ion batteries, a single discharging and charging cycle is sufficient. We recommend carrying out the process when the battery capacity indicated on the charger or on a Leica Geosystems product deviates significantly from the actual battery capacity available.

Operation/ discharging

- The batteries can be operated from -20 °C to +55 °C / -4 °F to +131 °F.
- Low operating temperatures reduce the capacity that can be drawn; high operating temperatures reduce the service life of the battery.

4.2.2

Battery for the TS Instrument

Change the battery step-by-step

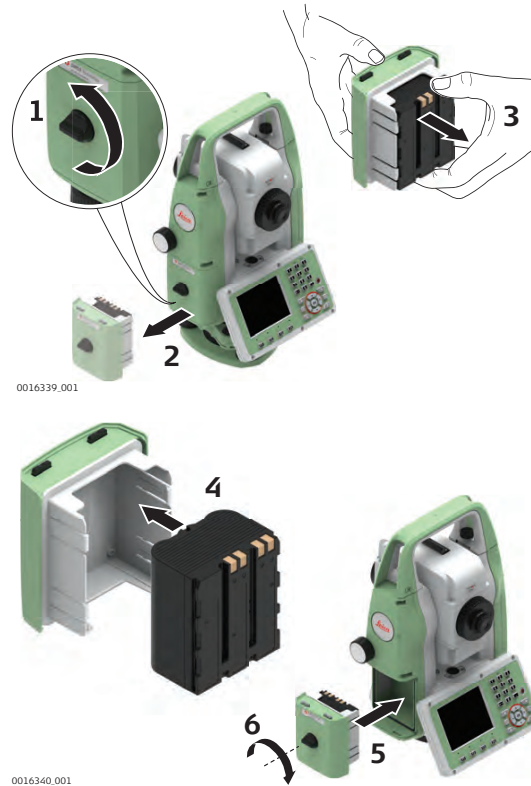

1. Face the instrument so that the vertical drive screw is on the left. The battery compartment is below the vertical drive. Turn the knob to the vertical position, opening the lid of the battery compartment.
2. Pull out the battery housing.
3. Pull the battery out of the battery housing.
4. At the top of the battery is a notch which corresponds to the inner surface of the battery housing. This notch helps you to place the battery correctly. Place the battery into the battery housing, ensuring that the contacts are facing outward. Click the battery into position.
5. Place the battery housing into the battery compartment. Push the battery housing in until it fits completely into the battery compartment.
6. Turn the knob to lock the battery compartment. Ensure that the knob is returned to its original horizontal position.

4.3

Data Storage

Description

An internal memory is included in all instruments. The FlexField firmware stores all data in jobs in a database in the internal memory.

Data can be transferred from the internal memory to a computer or other device via:

- a LEMO cable connected to the serial interface RS232 port
- an SD card
- an USB stick inserted into the USB host port,
- an USB cable connected to the USB device port, or
- a Bluetooth connection.
- WLAN
- an LTE antenna (TS07)

Refer to "12 Data Management" for further information on data management and data transfer.

 While other SD cards/USB sticks can be used, Leica Geosystems recommends to only use Leica SD cards/USB sticks and is not responsible for data loss or any other error that can occur while using a non-Leica SD card/USB stick.



Unplugging connecting cables or removing the SD card or USB stick during the measurement can cause loss of data. Only remove the SD card or USB stick or unplug connecting cables when the TS instrument is switched off.

Transfer data

Data can be transferred in various ways. Refer to "12 Data Management".



SD cards can directly be used in an OMNI drive as supplied by Leica Geosystems. Other PC card drives can require an adaptor.

4.4

Main Menu

Description

The **Main Menu** is the starting place for accessing all functionality of the instrument.







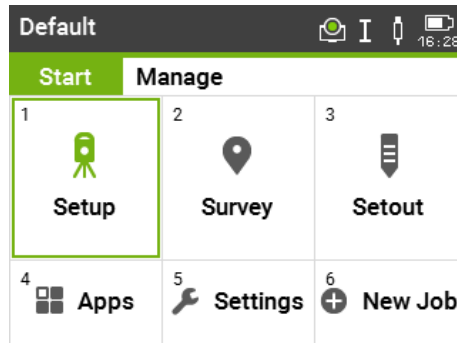







If desired, the instrument can be configured to start in a user-defined place after the Level/Plummet screen, instead of the **Main Menu**. Refer to "5.10 Startup Sequence".







Main Menu



Description of the Main Menu functions

Function	Description
Start page	
 Setup	Setup app to determine the station coordinates and station orientation when setting up a station. Refer to "7.2 Station Setup".

Function	Description
 Survey	Survey app to begin measuring. Refer to "7.3 Surveying".
 Setout	Setout app to place marks in the field at predetermined points. Refer to "7.4 Setout".
 Apps	To select and start apps. Refer to "7 Apps".
 Settings	To change EDM configurations, communication parameters and general instrument settings. To access instrument-related tools such as check and adjust, personal startup settings, PIN code settings, licence keys, system information and firmware upload. Refer to "5 Settings".
 New Job	To create a new job.
Manage page Contains all functions for entering, editing, checking and deleting data in the field. Refer to "12 Data Management".	
 Job	To select, view, create and delete jobs. Jobs are a summary of data of different types, for example, fixed points, measurements or codes. The job definition consists of the job name and user. The system generates time and date at the time of creation.
 Fixpoints	To view, create, edit and delete fixpoints. Fixpoints can have full coordinates (E, N, H) or position only or height only. To select a code from the existing codelist. To view all screenshots linked to the fixpoint.
 Meas.Data	To view, edit and delete measurement data. Measurement data available in the internal memory can be searched for via a specific point search, or by viewing all points within a job. The PtID, hr, code and code details can be edited.  If the details of a point have been edited, any new calculations will use the new point details. However, any previously stored calculation results based on the original coordinates of the point will not be updated.
 Data Transfer	To export and import data. Refer to "12.2 Exporting Data".
 Del.Data	To delete individual jobs, fixpoints and measurements of a specific job or all jobs in the memory.  Deleting the memory cannot be undone. After confirming the message all data is permanently deleted.

Function	Description
 USB-Stick	To view, delete, rename and create folders and files stored on the USB memory stick. Refer to "12.4 Working with a USB Memory Stick" and "B Directory Structure".
 SD Card	To view, delete, rename and create folders and files stored on the SD card.
 Int. Memory	To view, delete, rename and create folders and files stored in the internal memory. The internal memory has same folder structure like USB stick.
 Codes	To view, create, edit and delete codes. To each code a description and a maximum of 8 attributes with up to 16 characters each can be assigned.
 Formats	To view and delete data format files.
 ScrShots	To view, delete, link, unlink, sketch or view information of screenshots taken and stored. Refer to "11.2 Sketching" for sketching.

4.5

Distance Measurements - Guidelines for Correct Results

Description

An EDM is incorporated into the instrument. In all versions, the distance can be determined by using a visible red laser beam which emerges coaxially from the telescope objective. There are two EDM modes:

- Prism measurements
- Non-Prism measurements

Non-prism measurements

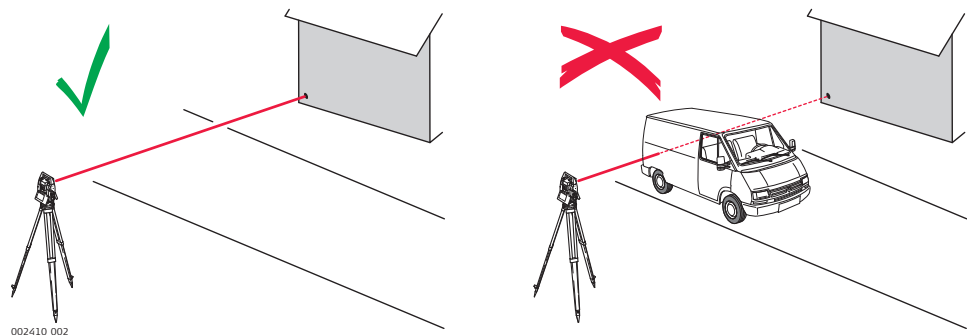

- When a distance measurement is triggered, the EDM measures to the object which is in the beam path at that moment. If a temporary obstruction, for example a passing vehicle, heavy rain, fog or snow is between the instrument and the point to be measured, the EDM may measure to the obstruction.
- Be sure that the laser beam is not reflected by anything close to the line of sight, for example highly reflective objects.
- Avoid interrupting the measuring beam while taking Non-Prism measurements or measurements using reflective foils.
- Do not measure with two instruments to the same target simultaneously.

Prism measurements

- Accurate measurements to prisms should be made in **Precise+** mode.
- Measurements to strongly reflecting targets such as traffic lights in Prism mode without a prism should be avoided. The measured distances may be wrong or inaccurate.
- When a distance measurement is triggered, the EDM measures to the object which is in the beam path at that moment. If for example people, cars, animals, or swaying branches cross the laser beam while a measurement is being taken, a fraction of the laser beam is reflected from these objects and may lead to incorrect distance values.
- Measurements to prisms are only critical if an object crosses the measuring beam at a distance of 0 to 30 m and the distance to be measured is more than 300 m.
- In practice, because the measuring time is very short, the user can always find a way of avoiding unwanted objects from interfering in the beam path.

WARNING

Due to laser safety regulations and measuring accuracy, using the Long Range Reflectorless EDM is only allowed to prisms that are more than 1000m (3300ft) away.

Red laser to prism

- **Prism (>4.0km)** mode enables distance measurements of over 4.0 km to standard prisms using the visible red laser beam.

Red laser to reflector tape

- The visible red laser beam can also be used to measure to reflective foils. To guarantee the accuracy the red laser beam must be perpendicular to the reflector tape and it must be well adjusted.
 - Make sure the additive constant belongs to the selected target (reflector).
-



5

Settings

5.1



Work Settings

Access

1. Select **Settings** from the **Main Menu**.

2. On the **General** page, select **Work**.

Work Settings

Description of fields

Field	Option	Description
Trigger Key 1		Quick key programmable with one of the functions:
	Off	The trigger key is deactivated.
	Meas	Sets the trigger key with the same function as Meas .
	Dist	Sets the trigger key with the same function as Dist .
	Store	Sets the trigger key with the same function as Store .
USER Key 1 USER Key 2	Selectable list	Configures the  /  keys with a function from the Favourites menu. Refer to "8 Favourites".
Tilt Correct	Off	Tilting compensation deactivated.
	On	2-axis compensation. Vertical angles refer to the plummet line and the horizontal directions are corrected by the standing axis tilt. For corrections depending on the Hz Corr. setting, refer to the table "Tilt and horizontal corrections".
		If the instrument is used on an unstable base, for example a shaking platform or ship, the compensator should be deactivated. This avoids the compensator drifting out of its measuring range and interrupting the measuring process by indicating an error.
Hz Corr.	On	Horizontal corrections are activated. For normal operation the horizontal correction should remain active. Each measured horizontal angle will be corrected, depending on the vertical angle. For corrections depending on the Tilt Correct setting, refer to the table "Tilt and horizontal corrections".
	Off	Horizontal corrections are deactivated.
Line1		Fixed to Point ID Shown on a page in Survey .
Line2 to Line14		The settings define the parameters shown on a page in Survey .

Field	Option	Description
	Target Height	Input field for prism height.
	Code	Editable field for codes.
	H_z angle	Display only field for the horizontal angle.
	V angle	Display only field for vertical angle.
	Hor. dist.	Display only field for horizontal distance.
	Slope dist.	Display only field for measured slope distance.
	Height diff.	Display only field for the height difference between station and reflector.
	Easting	Display only field for Easting coordinate of measured point.
	Northing	Display only field for Northing coordinate of measured point.
	Height	Display only field for the height coordinate of the measured point.
	Line space	Insert full line space.
Show in Map	Measurements	To display only measured points.
	Fixpoints	To display only fixpoints.
	Meas & Fixpts	To display measured points and fixpoints.
Show PtID	Yes	The ID of a point is displayed in the map.
	No	Display of point IDs in the map is deactivated.
Show PtCode	Yes	The code of a point is displayed in the map.
	No	Display of point codes in the map is deactivated.
Only 50 Pts	Yes	Only the first 50 point labels are displayed in the map.
	No	All point labels are displayed in the map, regardless of the number of points in the job.
Centre to		The selection changes the behaviour of the icon on the Mapview toolbar and the naming of the corresponding softkey.
	Station	To centre the map on the instrument.
	Target	To centre the map on the target.



Tilt and horizontal corrections

Setting		Correction			
Tilt correction	Horizontal correction	Incline longitudinal	Incline transversal	Horizontal collimation	Tilting axis
Off	On	No	No	Yes	Yes
On	On	Yes	Yes	Yes	Yes
Off	Off	No	No	No	No
On	Off	Yes	Yes	No	No

5.2

Regional Settings

Access

1. Select **Settings** from the **Main Menu**.

2. On the **General** page, select **Regional**.

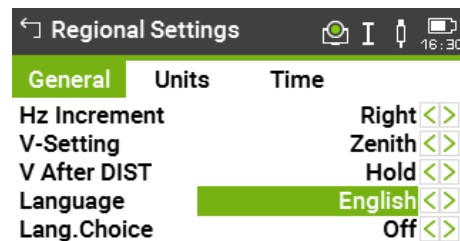
3. Press the  button to scroll through the screens of available settings.

Regional Settings



Key	Description
Delete	To delete an inactive language. Available when the language is highlighted.

Description of fields

Field	Option	Description
Hz Increment	Right	Set horizontal angle to clockwise direction measurement.
	Left	Set horizontal angle to counter-clockwise direction measurement. Counter-clockwise directions are displayed but are saved as clockwise directions.
V-Setting		Sets the vertical angle.

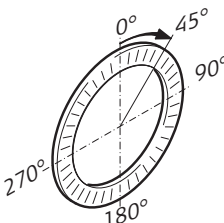
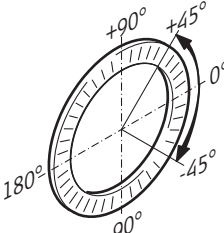
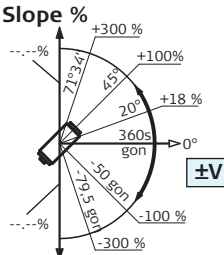
Field	Option	Description
	Zenith	 <p>Zenith=0°; Horizon=90°.</p>
	Horizon	 <p>Zenith=90°; Horizon=0°. Vertical angles are positive above the horizon and negative below it.</p>
	Slope [%]	 <p>45°=100%; Horizon=0°. Vertical angles are expressed in % with positive above the horizon and negative below it.</p> <p>☞ The % value increases rapidly. ---% appears on the display above 300%.</p>
	V After DIST	Sets if the vertical angle value recorded is the value that is displayed when Dist or when Store is pressed. The vertical angle field in a measurement screen always shows the running angle, regardless of this setting.
	Hold	The vertical angle value that is recorded is the value that was in the vertical angle field at the time Dist was pressed.
	Running	The vertical angle value that is recorded is the value in the vertical angle field at the time Store is pressed.
	☞	This setting is not applicable for the app Tie Distance or the favourites Hidden Point and Height Transfer. For these, the vertical angle is always running and the value recorded is the value when Store is pressed.



Field	Option	Description
Language	Selectable list	Sets the chosen language. Several languages can be uploaded onto the instrument. The current loaded language(s) are shown. A selected language can be deleted by pressing Delete . This function is available if more than one language is installed, and the selected language is not the chosen operating language.
	Lang.Choice	If multiple languages are loaded, a screen to choose the language can be shown directly after switching on the instrument.
	On	The language screen is shown as the startup screen.
	Off	The language screen is not shown as the startup screen.
Angle Unit		Sets the units shown for all angular fields. The setting of the angle units can be changed at any time. The current displayed values are converted according to the selected unit.
	°"	Degree sexagesimal. Possible angle values: 0° to 359°59'59"
	dec. deg	Degree decimal. Possible angle values: 0° to 359.999°
	gon	Gon. Possible angle values: 0 to 399.999 gon
	mil (6000) mil (6400)	Mil. Possible angle values: 0 to 5999.99 mil. Mil. Possible angle values: 0 to 6399.99 mil.
Min. Reading		Sets the number of decimal places shown for all angular fields. This is for data display and does not apply to data export or storage.
	°"	(0° 00' 0.1"/0° 00' 01"/0° 00' 05"/ 0° 00' 10")
	dec. deg	(0.0001 / 0.0005 / 0.001)
	gon	(0.0001 / 0.0005 / 0.001)
	mil (6000) and mil (6400)	(0.01 / 0.05 / 0.1)
Dist. Unit		Sets the units shown for all distance and coordinate related fields.
	metre	Metres [m].
	US-ft	US feet [ft].
	INT-ft ft-in/16	International feet [fi]. US feet-inch-1/16 inch [ft].
Dist.Deci- mal		Sets the number of decimal places shown for all distance fields. This is for data display and does not apply to data export or storage.
	3	Displays distance with three decimals.

Field	Option	Description
	4	Displays distance with four decimals.
Temp. Unit		Sets the units shown for all temperature fields.
	°C	Degree Celsius.
	°F	Degree Fahrenheit.
Press.Unit		Sets the units shown for all pressure fields.
	hPa	Hecto Pascal.
	mbar	Millibar.
	mmHg	Millimeter mercury.
Grade Unit		Sets how the slope gradient is calculated.
	h:v	Horizontal : Vertical, for example 5 : 1.
	v:h	Vertical : Horizontal, for example 1 : 5.
	%	(v/h x 100), for example 20 %.
Time (24h)		The current time.
Date		Shows an example of the selected date format.
Format	dd.mm.yyyy, mm.dd.yyyy or yyyy.mm.dd	How the date is shown in all date-related fields.

5.3

Data Settings

Access

1. Select **Settings** from the **Main Menu**.

2. On the **General** page, select **Data**.

3. Press the  button to scroll through the screens of available settings.

Data Settings

Description of fields



Field	Option	Description
Double PtID		Sets if multiple points are able to be recorded with the same point ID in the same job.
	Allowed	Allows multiple points with the same point ID.
	Not Allowed	Does not allow multiple points with the same point ID.
Sort Type	Time	Lists are sorted by time of entry.
	PtID	Lists are sorted by Point IDs.
Sort Order	Descending	Lists are ordered in descending order of sort type.

Field	Option	Description
	Ascending	Lists are ordered in ascending order of sort type.
Code Record	Before Meas. or After Meas.	Sets if the codeblock is saved before or after the measurement. Refer to "9 Coding".
Code		Sets if the code will be used for one, or many, measurements.
	Reset after Rec	The set code is cleared from the measurement screen after Meas or Store is selected.
	Permanent	The set code remains in the measurement screen until manually deleted.
Data Output		Sets the location for data storage.
	Internal Memory	All data is recorded in the internal memory.
	Interface	Data which is normally stored in the onboard data base will be sent to the interface selected in the Interface Settings screen This Data Output setting is only required if an external storage device is connected and measurements are started at the instrument with Dist/Store or Meas. This setting is not required if the instrument is totally controlled by a datalogger.
GSI-Format		Sets the GSI output format.
	GSI 8	81..00+12345678
	GSI 16	81..00+1234567890123456
GSI-Mask		Sets the GSI output mask.
	Mask 1	PtID, Hz, V, SD, ppm+mm, hr, hi
	Mask 2	PtID, Hz, V, SD, E, N, H, hr
	Mask 3	StationID, E, N, H, hi (Station) StationID, Ori, E, N, H, hi (Station Result) PtID, E, N, H (Control) PtID, Hz, V (Set Azimuth) PtID, Hz, V, SD, ppm+mm, hr, E, N, H (Measurement)

5.4



Screen & Audio Settings

Access

1. Select **Settings** from the **Main Menu**.

2. On the **General** page, select **Screen...**.

3. Press the  button to scroll through the screens of available settings.

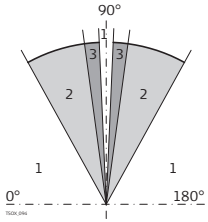
Screen & Audio Settings

Description of fields

Field	Option	Description
Display Illum.	Off to 100%	Sets the display illumination in 20% steps.
Reticle Illum.	Off to 100%	Sets the reticle illumination in 10% steps.
Touch Screen		Available for Color and Color&Touch screen only.
	On	The touch screen is activated.
	Off	The touch screen is deactivated.
		 Press Calib. to calibrate the touch screen. Follow the instructions on the screen
Screensaver	after 1 min, after 2 min, after 5 min, after 10 min	The screensaver is activated and starts after the selected time.
	Off	The screensaver is deactivated.
Appl.Descrip.	All	To switch on the app description in the app pre-settings. Refer to "Starting an App".
	Standard	To switch off the app description in the app pre-settings. Refer to "Starting an App".
		 The method descriptions for apps with different methods, for example COGO, cannot be switched off.
Beep		The beep is an acoustic signal after each key stroke.
	Normal	Normal volume.
	Loud	Increased volume.
	Off	Beep is deactivated.
Sector Beep	On	Sector beep sounds at right angles (0°, 90°, 180°, 270° or 0, 100, 200, 300 gon).
		
		1 No beep 2 Fast beep; from 95.0 to 99.5 gon and 105.0 to 100.5 gon. 3 Permanent beep; from 99.5 to 99.995 gon and from 100.5 to 100.005 gon.
	Off	Sector Beep is deactivated.

Field	Option	Description
Setout Beep	On	The instrument beeps when the distance from the current position to the point to be staked is ≤ 0.5 m. The closer the prism is to the point to be staked the faster the beeps will be.
	Off	Beep is deactivated.



5.5

EDM Settings

Description

The settings on this screen define the active EDM, **E**lectronic **D**istance **M**easurement. Different settings for measurements are available with Non-Prism (NP) and Prism (P) EDM modes.

Access

1. Select **Settings** from the **Main Menu**.

2. On the **General** page, select **EDM**.

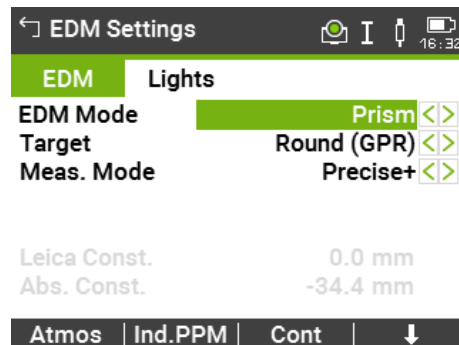
3. Press the  button to scroll through the screens of available settings.



EDM Settings



Key	Description
Atmos	To enter atmospheric data ppm.
Ind.PPM	To enter an individual ppm value.
↓	To enter projection scale details.
Scale	
↓	To view EDM Signal reflection value.
Signal	
↓	To view the EDM frequency.
Freq.	

Description of fields

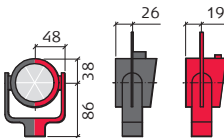
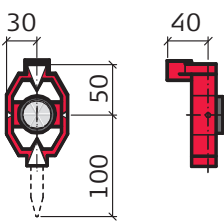
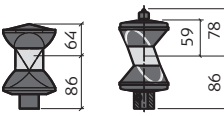
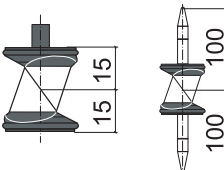
Field	Description	Description
EDM Mode	Prism	For distance measurements using prisms.
	Non-Prism	For distance measurements without prisms.
	Tape	For distance measurements using Retro reflective targets (3 mm + 2 ppm).

Field	Description	Description	
Target	Round (GPR)		Standard prism GPR121/GPR111 Leica Const.: 0.0 mm
	Mini (GMP) Mini0 (GMP111-0)		GMP111 Leica Const.: +17.5mm GMP111-0 Leica Const.: 0.0 mm
	360° (GRZ4)		GRZ4/GPZ122 Leica Const.: +23.1mm
	360°Mini(GRZ101)		GRZ101 Leica Const.: +30.0mm
	Tape (GZM)		Leica Const.: +34.4mm
	360° (MPR122)		MPR122 Leica Const.: +28.1mm
	None	Without prism	Leica Const.: +34.4mm
User 1 / User 2	For any prism modes, the user can define two of their own prisms. Constants can be entered in mm in either Leica Const. or Abs. Const. . For example: User prism constant = -30.0mm Leica Const. = +4.4 mm (34.4 + -30 = 4.4) Abs. Const. = -30.0mm		
Meas. Mode	Precise+	Fine measuring mode for highest precision measurements with prisms (1 mm + 1.5 ppm).	
	Pre-cise&Fast	Quick measuring mode with prisms, with higher measuring speed and high accuracy (2 mm + 1.5 ppm).	
	Precise	For distance measurements without prisms (2 mm + 2 ppm; >500 m: 4 mm + 2 ppm).	

Field	Description	Description
	Average	Repeats measurements in standard measuring mode. Define the number of repetitions in No. of Meas. . The average distance and the standard deviation for the averaged distance are calculated. During the measurement, a status bar, the calculated slope distance and the standard deviation are displayed. Use Back to return to the previous screen without storing the data. Use Re-meas to omit all previous measurements and to restart. Use Cont to cancel the measurement process and to calculate the average from the available measurements.
	Tracking	For continuous distance measurements with prisms (3 mm + 1.5 ppm) or without prisms (5 mm + 3 ppm).
	Prism (>4.0km)	For long range distance measurements with prisms (5 mm + 2 ppm).
No. of Meas.	Editable field	The number of repeated measurements. Limit value: 2 to 99
Leica Const.	Display only	This field displays the Leica prism constant for the selected Prism Type .
	Editable field	Where Prism Type is User 1 or User 2 this field becomes editable to set a user defined constant. Input can only be made in mm. Limit value: -999.9mm to +999.9mm.
Abs. Const.	Display only	This field displays the absolute prism constant for the selected Prism Type .
	Editable field	Where Prism Type is User 1 or User 2 this field becomes editable to set a user defined constant. Input can only be made in mm. Limit value: -999.9mm to +999.9mm.
Laser-Point	Off	Visible laser beam is deactivated.
	On	Visible laser beam for visualising the target point is activated.
Guide Light	Off	Guide Light is deactivated.
	On	Guide Light is activated. The person at the prism can be guided by the flashing lights directly to the line of sight. The light points are visible up to a distance of 150 meters. This is useful when staking out points.

Field	Description	Description
-------	-------------	-------------

Working range:
 5m to 150m (15ft to 500ft)
 Positioning accuracy:
 5cm at 100m (1.97" at 330ft)

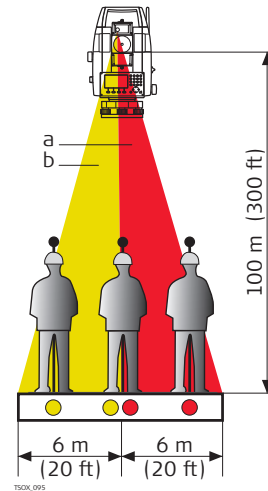

- a Flashing red diode
- b Flashing yellow diode

EDM Settings - Enter Atmospheric Data

This screen enables the entry of atmospheric parameters. Distance measurement is influenced directly by the atmospheric conditions of the air in which the measurements are taken. In order to take these influences into consideration distance measurements are corrected using atmospheric correction parameters.

The refraction correction is taken into account in the calculation of the height differences and the horizontal distance. Refer to "16.7 Scale Correction" for the application of the values entered in this screen.

 When **PPM=0** is selected, the Leica standard atmosphere of 1013.25mbar, 12°C, and 60% relative humidity is applied.

Description of fields

Field	Option	Description
Temp.Meas.	Auto	When a distance is measured using Meas or Dist , the temperature is read from the instrument temperature sensor. The value is displayed in the Temperature field. The atmospheric ppm is recalculated and displayed in the Atmos PPM field. Measured distances are corrected with the new atmospheric ppm.
	Single	When pressing Temp , the temperature is read from the instrument temperature sensor. The value is displayed in the Temperature field. The atmospheric ppm is recalculated and displayed in the Atmos PPM field.
	Manual	The temperature value can be entered manually.

EDM Settings - Enter Projection Scale

This screen enables entry of the scale of projection. Coordinates are corrected with the PPM parameter. Refer to "16.7 Scale Correction" for the application of the values entered on this screen.

EDM Settings - Enter Individual PPM

This screen enables the entry of individual scaling factors. Coordinates and distance measurements are corrected with the PPM parameter. Refer to "16.7 Scale Correction" for the application of the values entered on this screen.

EDM Settings - EDM Signal Reflection

This screen tests the EDM signal strength (reflection strength) in steps of 1%. Enables optimal aiming at distant, barely visible, targets. A percentage bar and a beeping sound, indicate the reflection strength. The faster the beep the stronger the reflection.

ppm handling

General handling

Handling of	Geom.ppm	Atmos. ppm	Indiv. ppm
Slope distance	Not applied	Applied	Not applied
Horizontal distance	Not applied	Applied	Applied
Coordinates	Applied	Applied	Applied

Exceptions

- Setout

Geometric reduction values are applied to calculate and display the horizontal distance difference so that the position of points to be staked is found correctly.

- LandXML Data and HeXML

To import and use the measurements into Leica Infinity, the distances recorded in LandXML differ from the distances on the instrument.

Handling of	Geom. ppm	Atmos. ppm	Indiv. ppm	ppm tag
Slope distance	Not applied	Applied	Not applied	Available
Horizontal distance	Applied	Applied	Applied	Unavailable
Coordinates	Applied	Applied	Applied	Unavailable



5.6

Interface Settings

Description

For data transfer the communication parameters of the instrument must be set.

Access

1. Select **Settings** from the **Main Menu**.

2. On the **Connect.** page, select **Interface**.

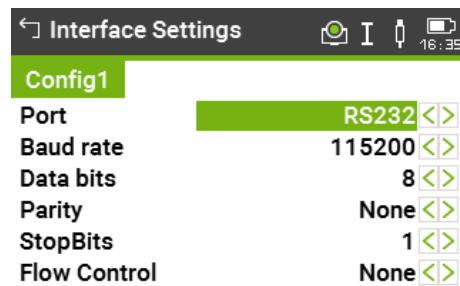
Interface Settings



Default Cont

Key	Description
BT-PIN	To set a PIN code for the Bluetooth connection. The default Bluetooth PIN is '0000'.
Default	To reset the fields to the default Leica standard settings. Available for RS232 .

Description of fields

Field	Option	Description
Port		Instrument port.
	Bluetooth	Communication is via Bluetooth.
	WLAN	Communication is via WLAN.
	RS232	Communication is via RS232.

The following fields are active only when **Port: RS232** is set.

Field	Option	Description
Baud rate	1200, 2400, 4800, 9600, 14400, 19200, 38400, 57600, 115200	Speed of data transfer from receiver to device in bits per second.
Data bits	7 8	Number of bits in a block of digital data. Data transfer is realised with 7 databits. Data transfer is realised with 8 databits.
Parity	Even Odd None	Even parity. Available if data bit is set to 7. Odd parity. Available if data bit is set to 7. No parity. Available if data bit is set to 8.
StopBits	Editable field	Number of bits at the end of a block of digital data.
Flow Control	RTS/CTS or None	Activates hardware handshake. When the instrument/device is ready for data, it asserts the Ready To Send line indicating it is ready to receive data. This line is read by the sender at the Clear To Send input, indicating it is clear to send the data.

The following fields are active only when **Port: WLAN** is set.

Field	Option	Description
IP address	Display only	Local IP address of
TCP/IP port	Display only	TCP/IP port number in use.

Leica standard settings

When **Default** is selected the communication parameters are reset to the default Leica standard settings:

- 115200 Baud, 8 Databit, No Parity, No Flow Control, 1 Stopbit.

Interface plug connections



- a External battery
- b Not connected / inactive
- c GND
- d Data reception (TH_RXD)
- e Data transfer (TH_TXD)

5.7

FTP Client

Description



This functionality is to transfer jobs, codelists and other files on the data storage device with a standard and simple FTP server.

FTP protocol is used to transfer between an instrument, which has an Internet device connected, and the FTP server. The zip/unzip functionality is included.



Configure and connect the Internet interface before using this function.

Access

1. Select **Settings** from the **Main Menu**.

2. On the **General** page, select **FTP**.

3. Press the  button to scroll through the screens of available settings.

FTP Data Transfer

Key	Description
Connect	To connect to the FTP server entered.

Description of fields

Field	Description	Description
Host	Editable field	In order to get access to the Internet, a host name is required. This host name is the name of the FTP server in the Internet.
Port	Editable field	Port to be used. Any number between 0 and 65535 is valid.
User ID	Editable field	The User ID allows connection to the FTP site. If no value is typed in, then the instrument logs in to the FTP server anonymously, if allowed.
Password	Editable field	The password to get access to the FTP site.

Next step

Connect. Once the connection to the FTP server is established, the **FTP Data Transfer, Local** page is displayed.

FTP Data Transfer, Local page

The files and folders on the selected data storage device of the instrument are displayed including their size. To get into the folders, highlight the folder and **OK**.

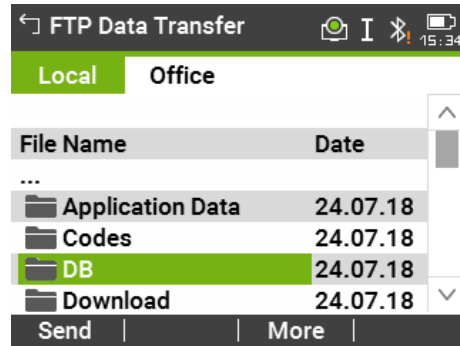

Key	Description
Send	To copy the file to its corresponding directory on the FTP server.
USB	To change between the data storage devices and the internal memory.
More	To change between date, time and size.

FTP Data Transfer, Office page

The files located on the FTP server are displayed.



Whenever switching to this page, if the connection to the server was disconnected, then a refresh action is done or it reconnects to the server.

Key	Description
Get	To download the highlighted file list on the FTP server to the local download folder. Downloaded files are stored in the selected directory.
More	To change between date, time and size.

5.8

Internet Settings

Access

1. Select **Settings** from the **Main Menu**.

2. On the **Connect.** page, select **Internet**.

3. Press the  button to scroll through the screens of available settings.

Internet Settings

Description of fields

Field	Option	Description
Device	Selectable list	The device for the connection to the Internet.
Name	Display only	The name of the selected device.
PIN-Code	Editable field	To enter the Personal Identification Number of the SIM card.
PUK-Code	Editable field	If the PIN is locked for any reason, for example the wrong PIN was entered, input the Personal UnblockKing code for access to the PIN.

Field	Option	Description
Auto select	Yes or No	Select this option for a manual or automatic provider selection.
APN	Editable field	APN (Access Point Name of a server from the network provider). Contact your provider to get the correct APN.
APN cont.	Editable field	Access Point Name of a server from the network provider. The APN can be thought of as the home page of a provider supporting data transfer.
User ID	Yes	A user identification for the APN service can be typed in.
	No	A user identification for the APN service is not required.
User ID	Editable field	Enter the User identification number.
Password	Editable field	Password for User ID .



5.9

Adjust

Description

The **Adjustments Menu** contains tools to be used for the electronic adjustment of the instrument and for setting adjustment reminders. Using these tools helps to maintain the measuring accuracy of the instrument.

Access

1. Select **Settings** from the **Main Menu**.

2. On the **Tools** page, select **Adjust**.

3. Select an adjustment option from the **Adjustments** screen.

Adjustment options

In the **Adjustments** screen, there are several adjustment options.

Menu selection	Description
HZ-Collimation	Refer to "13.3 Adjusting Line-of-Sight and Vertical Index Error".
Vertical Index	Refer to "13.3 Adjusting Line-of-Sight and Vertical Index Error".
Compensator Index	Refer to "13.4 Adjusting the Compensator".
Tilting Axis	Refer to "13.5 Adjusting the Tilting Axis Error".

Menu selection	Description
View Current Adj. Data	Displays the current adjustment values that have been set for Hz-Collimation, V-index and Tilt Axis.
Adjustment Reminder	Defines the time period from the last adjustment to when a reminder message should display to do another adjustment. Options are: Never, 2 weeks, 1 month, 3 months, 6 months, 12months. The message will display the next time the instrument is switched on after the time period has been reached.



5.10

Startup Sequence

Description

Through the Startup tool, it is possible to record a user-defined sequence of key presses so that, after switching on the instrument, a particular screen can be displayed after the **Level & Plummet** screen instead of the **Main Menu**. For example, the general **Settings** screen for configuring the instrument settings.

Access

1. Select **Settings** from the **Main Menu**.

2. On the **Tools** page, select **Startup**.

Auto start step-by-step

1. Press **Record** in the **Startup** screen.
2. Press **Cont** to confirm the information message and begin the recording process.
3. The next key presses are stored, up to a maximum of 64. To end the recording press **ESC**.
4. If the auto start **Status** is set to **Active**, the stored key presses will be executed automatically after switching on the instrument.



The automatic start sequence has the same effect as pressing the keys manually. Certain instrument settings cannot be made in this way. Relative entries such as automatically setting **EDM Mode: Precise&Fast** upon switching on the instrument, are not possible.

5.11

System Information

Description



The **Info** screen displays:

- Instrument, system and firmware information
- Maintenance and service dates
- Memory usage
- Settings for the date and time



Please provide the instrument-related information, such as instrument type, serial number and equipment number, as well as the firmware version and build number when contacting support.

Access

1. Select **Settings** from the **Main Menu**.

2. On the **Tools** page, select **Info**.

3. Press the  button to scroll through the screens of available settings.

Info

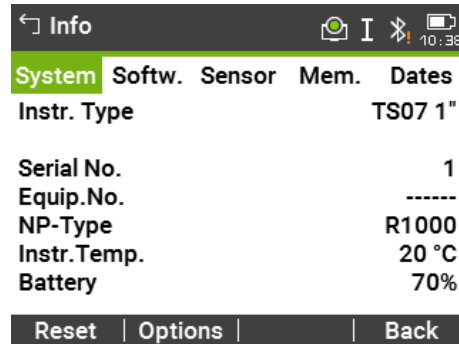
Page 1/5 or System

This screen displays information about the instrument and operating system.



System	Softw.	Sensor	Mem.	Dates
Instr. Type				TS07 1"
Serial No.				1
Equip.No.				-----
NP-Type				R1000
Instr.Temp.				20 °C
Battery				70%

Reset | Options | Back

Key	Description
Reset	To reset all settings to the system default.
Options	To display hardware related options.

Page 2/5 or Softw.

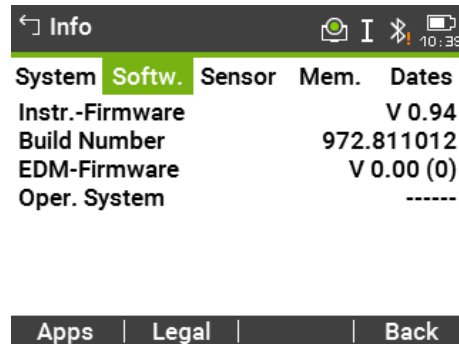

System	Softw.	Sensor	Mem.	Dates
Instr.-Firmware				V 0.94
Build Number				972.811012
EDM-Firmware				V 0.00 (0)
Oper. System				-----

Apps | Legal | Back

Key	Description
Apps	To display a list of the apps available on the instrument. A check mark is display in the check box beside each app that is licenced.
Legal	To display the Software Licence Agreement.

Description of fields

Field	Option	Description
Instr.-Firm-ware	Display only	Displays the firmware version number instal- led on the instrument.
Build Num-ber	Display only	Displays the build number of the firmware.

Field	Option	Description
Active Language	Display only	Displays the current language and version number selected for the instrument.
EDM-Firmware	Display only	Displays the version number of the EDM firmware.
Oper. System	Display only	Displays the operating system of the instrument.

Page 3/5 or Sensor

Field	Option	Description
Loader Angle Hz	Display only	Loader version for the horizontal angle system
Loader Angle V	Display only	Loader version for the vertical angle system
Loader Inclinat.	Display only	Loader version for the inclination system
Angle Hz	Display only	Software version of the horizontal angle system
Angle V	Display only	Software version of the vertical angle system
Inclination	Display only	Software version of the inclination system
AutoHeight	Display only	Displays the firmware version of the AutoHeight laser plummet. Available for TS07.

Page 4/5 or Mem.

Displays job-specific memory information such as the number of stored stations and fixpoints within a job, the number of recorded data blocks, for example measured points, or codes within a job, and the memory space occupied.



Before pressing **Format**, to format the internal memory, ensure that all important data is first transferred to a computer. Jobs, formats, codelists, configuration files, uploaded languages and firmware are deleted by formatting.



Despite an automatic defragmentation, the memory gets fragmented after a while. Please format the internal memory periodically to maintain the instrument performance.

Page 5/5 or Dates

Field	Option	Description
Maint.-End Date	Display only	Displays the end date of the maintenance agreement for the instrument firmware.
mySec.Renewal Date	Display only	The date when the instrument must be connected to mySecurity in order to renew the security functionality.
Next Service Date	Display only	Displays the date of the next service check required. The field can be invisible if turned off by the service reminder.



5.12

Licence Keys

Description

To fully activate hardware functionality, firmware applications and firmware contracts, licence keys may be required on the instrument. Licence keys can be uploaded via Leica Infinity, the USB memory stick or the SD card.

Access

1. Select **Settings** from the **Main Menu**.

2. On the **Tools** page, select **Licence**.

Upload Licence Key

Key	Description
Delete	Deletes all firmware licence keys on the instrument and the firmware maintenance licence.

Description of fields

Field	Option	Description
Method	USB-Stick or SD Card	The licence key file is uploaded from the data storage device.



5.13

Instrument Protection with PIN

Description

The instrument can be protected by a Personal Identification Number. If PIN protection is activated, the instrument will always prompt for a PIN code entry before starting up. If a wrong PIN has been entered five times, a Personal Unblocking (PUK) code is required. This can be found on the instrument delivery papers.

Activate PIN code step-by-step

1. Select **Settings** from the **Main Menu**.

2. On the **Tools** page, select **PIN**.

3. Activate PIN protection by setting **Use PIN-Code: On**.
4. Enter a personal PIN Code (max. 6 numerics) in the **New PIN-Code** field.
5. Accept with **Cont**.



Now the instrument is protected against unauthorised use. After switching on the instrument, a PIN code entry is necessary.

Lock instrument step-by-step

If PIN protection is activated, it is possible to lock the instrument from within any app without switching off the instrument.



1. Press the Favourites key when within any app.
2. Select **PIN-lock** from the **Favourites Menu**.

Entering the PUK code

If a wrong PIN has been entered five times, the system will prompt for a Personal Unblocking code. The PUK code must be ordered from your Leica Geosystems representative.

If the PUK code entered is correct then the instrument will start up and reset the PIN code to default value **0** and **Use PIN-Code: Off**.

Deactivate PIN code step-by-step

1. Select **Settings** from the **Main Menu**.

2. On the **Tools** page, select **PIN**.

3. Enter the current PIN in **PIN-Code:**.
4. Accept with **Cont**.
5. Deactivate PIN protection by setting **Use PIN-Code: Off**.
6. Accept with **Cont**.



The instrument is now no longer protected against unauthorised use.



5.14

Loading Software

Description

Uploads are possible from the USB memory stick or the SD card. Alternatively use myWorld to upload files.

Access

1. Select **Settings** from the **Main Menu**.

2. On the **Tools** page, select **Load FW**.



Never disconnect the power supply during the system upload process. The battery must be at least 80% capacity before commencing the upload.

Loading firmware and languages step-by-step



All firmware and language files must be stored in the \SYSTEM folder to be transferred to the instrument. The upload file has the extension *.fw.

To load firmware and languages at once



All freely available languages are installed automatically with a firmware upload.

1. Select **F1 Firmware**. The **Select File!** screen will appear.
2. Select the firmware file from the \SYSTEM folder of the USB memory stick or SD card.
3. Press **Cont**.
4. Once successfully loaded, the system will shut down and restart again automatically.

To load language files separately

1. Select **F2 Language**.
2. Select the language file from the \SYSTEM folder of the USB memory stick or SD card.
3. Press **Cont**.

4. The **Upload Languages!** screen will appear displaying all language files. Select **Yes** or **No** for a language file to be uploaded. At least one language must be set to **Yes**.

 5. Press **Cont.**



 6. Once successfully loaded, the system will shut down and restart again automatically.
-

6 Apps - Getting Started

6.1 Overview



Description

Apps are predefined programs, that cover a wide spectrum of surveying duties and facilitate daily work in the field. The following apps are available, although app packages for each instrument may vary from that stated below:

App	TS03	TS07
Station Setup	✓	✓
Survey	✓	✓
Setout	✓	✓
Tie Distance	✓	✓
COGO	✓	✓
Area & DTM Volume	✓	✓
Remote Height	✓	✓
Traverse	Optional	Optional
Reference Line	✓	✓
Reference Arc	✓	✓
Reference Plane	✓	✓
Road 2D	Optional	✓
Road 3D	Optional	Optional
Tunnel	Optional	Optional
 Refer to the separate manual "Leica TS03/TS07 Tunnel Application".		
Mining	Optional	Optional
 Refer to the separate manual "Leica TS03/TS07 Mining Application".		

6.2 Starting an App

Access

1. Select **Apps** from the **Main Menu**.

2. Press the  button to scroll through the screens of available apps.
3. Press the number of the app (for TS03) or tab on an icon (for TS07) to select the specified app in the **Programs Menu**.

Pre-settings screens

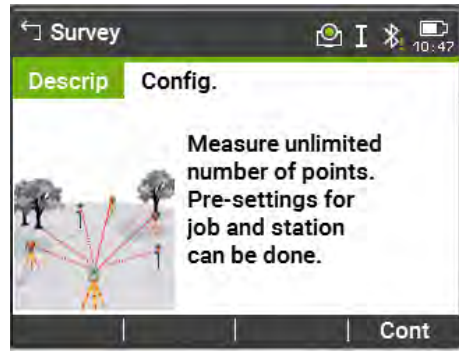
Pre-settings for Survey is shown as an example. Any additional settings for particular apps are explained within the chapters for those apps.



Page key for TS03 or tap on page for TS07 to change to another page. Refer to "5.4 Screen & Audio Settings" to turn off the app description.

Cont To change to the next screen.

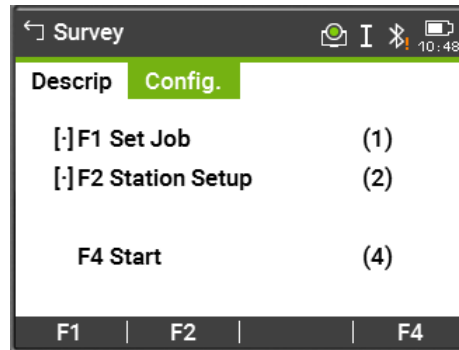

[•] = Setting has been made.
[] = Setting has not been made.

F1-F4 To select menu item.

Description of fields

Field	Description
F1 Set Job	To define the job where data will be saved. Refer to "6.3 Setting the Job".
F2 Station Setup	To determine the station coordinates and station orientation. Refer to "6.4 Station Setup".
F4 Start	Starts the selected app.

6.3

Setting the Job

Description

All data is saved in Jobs, like file directories. Jobs contain measurement data of different types, for example measurements, codes, fixpoints or stations. Jobs are individually manageable and can be exported, edited or deleted separately.

Access

Select **F1 Set Job** in **Config.** screen.

Select Job

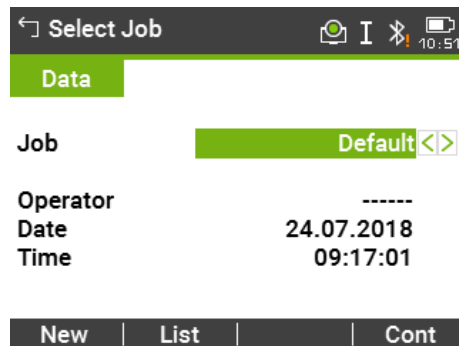

Key	Description
Cont	To continue with the selected job.
New	To create a new job.
List	To display the list of available jobs.

Description of fields

Field	Option	Description
Job	Selectable list	Name of an existing job to be used.
Operator	Editable field	Name of operator, if entered.
Date	Display only	Date the selected job was created.
Time	Display only	Time the selected job was created.

Job list

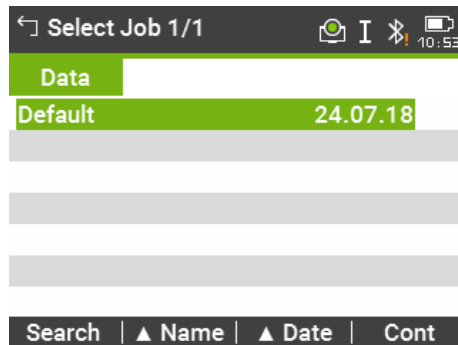

Key	Description
Search	To search for a job. Refer to "3.7 Pointsearch".
▼ Name and ▲ Name	To sort the list according to ascending or descending job names.
▼ Date and ▲ Date	To sort the list according to ascending or descending job creation dates.

Description of columns

Column	Description
First column	Name of an existing job.
Second column	Date the jobs were created.

Recorded data

Once a job is set up, all subsequent recorded data will be stored in this job. The last used job is the active job.

If no job was defined and an app was started, then the system automatically creates a new job and names it "Default".

Next step

Press **Cont** to confirm the job and return to the **Config.** screen.

6.4

Station Setup

Description

All measurements and coordinate computations are referenced to the set station coordinates and orientation.

Station coordinate calculation

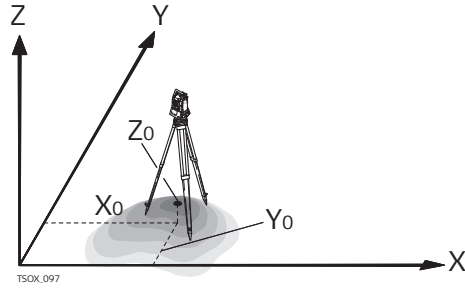

Directions

- X Easting
- Y Northing
- Z Height

Station coordinates

- X0 Easting coordinate of station
- Y0 Northing coordinate of station
- Z0 Height of station

Station orientation calculation

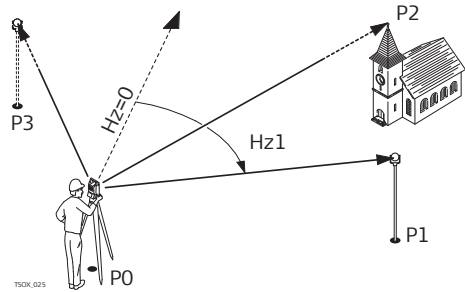

Known coordinates

- P0 Instrument station
- P1 Target point
- P2 Target point
- P3 Target point

Calculations

- Hz1 Station orientation

Access

Select **F2 Station Setup** in **Config.** screen.

Next step

The Station Setup app begins. Refer to "7.2 Station Setup" for information on the Station Setup process.



If no station was set and an app was started, then the last station is set as the current station and the current horizontal direction is set as the orientation.

7

Apps

7.1

Common Fields

Description of fields

The following table describes common fields that are found within the firm-ware apps. These fields are described here once and not repeated in the app chapters unless the field has a specific meaning within that app.

Field	Description
PtID, Point, Point 1	Point ID of the point.
hr	Height of the reflector.
Remark / Code	Remark or Code name depending on the coding method. Three coding methods are available: <ul style="list-style-type: none">• Remark coding: This text is stored with the corresponding measurement. The code is not related to a codelist, it is just a simple remark. A codelist on the instrument is not necessary.• Expanded coding with codelist: ↓ Code The code that was entered is searched for within the code list and it is possible to see, change and/or add attributes to the code. To toggle through the codelist, change to page 4/4 for TS03 or to page Code for TS07.• Quick coding: ↓ Q-Code Enter the shortcut to the code. The code is selected and the measurement starts.
Hz	Horizontal direction to the point.
V	Vertical angle to the point.
↖	Horizontal distance to the point.
↗	Slope distance to the point.
↘	Height to the point.
East	Easting coordinate of the point.
North	Northing coordinate of the point.
Height	Height coordinate of the point.

7.2

Station Setup

7.2.1

Starting

Description

Station Setup is an app used when setting up a station, to determine the station coordinates and station orientation. A maximum number of 10 known points can be used to determine the position and orientation.

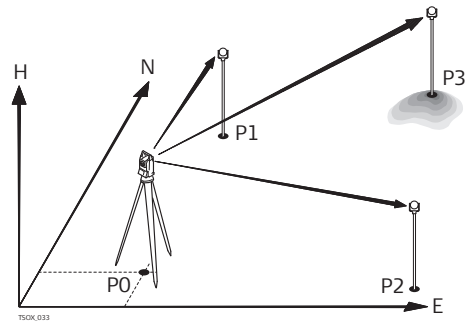

- P0 Instrument station
- P1 Known point
- P2 Known point
- P3 Known point

Setup methods

The following setup methods are available:

Setup method	Description
Orientation with Angle	The station is known. Aim at a target to set the orientation.
Orientation with Coordinates	The station and target coordinates are known. Aim at a target to set the orientation and height.
Height Transfer	The station is known, a new station height must be computed. Measure to one or more known targets to compute new height for the station.
Resection	The station is unknown. Measure to two or more target points to compute station coordinates and orientation. Scale setting is configurable.
Helmert Resection	<p>The station is unknown. Measure to two or more target points to compute station coordinates and orientation. The measured angles and distances are adjusted, based on coordinates of a local and global system.</p> <p>A 2D Helmert transformation is used, with four (shift x, shift y, rotation and scale) or three (shift x, shift y, rotation) parameters, depending on the scale setting in the configuration. Points can be defined as 1D, 2D or 3D.</p>
Local Resection	<p>The station is unknown. Measure distances to two points:</p> <ul style="list-style-type: none"> • To the origin ($E = 0, N = 0, H = 0$) of the coordinate system • To a point the North or East direction of the coordinate system <p>Scale and standard deviation are not calculated.</p>

Each setup method requires different input data and a different number of target points.

Access

1. Select **Apps** from the **Main Menu**.

2. Select **Setup** from the **Programs Menu**.

3. Select a job. Refer to "6 Apps - Getting Started".

4. Select **F2 Settings**:
 - Set the standard deviation limits for the position, height, Hz orientation, and the Face I-II difference. For Local Resection, define the positive North or positive East axis. For Resection Helmert, set the distance weighting that is used in the calculation of the station height in the Resection. The height weighting can be configured.
 Set **Calc.new Scale: Yes** to calculate the scale for the setup methods Resection and Resection Helmert. The scale can then be set at the end of the Resection calculation. Measured distances are always reduced with the scale set on the instrument. The computed scale is applied on the coordinates.
 - Press **Cont** to save the limits and return to the **Station Setup** screen.

5. Select **F4 Start** to begin the app.

Enter Station Data

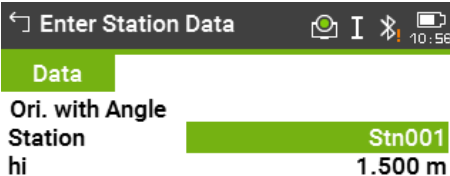

Key	Description
Meas H	Optional for TS07. To measure the instrument height using the integrated AutoHeight laser plummet. Refer to "Measure Station Height".

1. Select the desired setup method.

2. Enter the station number or press **Find** or **List** to select an existing point. If the entered station number can not be found in the current job, then the **Point Search** screen appears. Select a different job to search or press **New** to enter the coordinates manually. **New** is only available for the methods Ori. with Angle, Ori. with Coord. and H-Trans.

3. For all methods except Ori. with Angle and Local Resection, press **Cont** to continue to the **Enter Target Point** screen.
 For the Ori. with Angle method, **Cont** continues to the **Manual Angle Setting** screen. Refer to "7.2.2 Measuring the Target Points", "Manual Angle Setting".

For the Local Resection method, **Cont** continues to the **Meas. Pt1: Origin (0/0/0)** screen. The first point measured is the origin of the coordinate system. The second point measured is, depending on the setting, either the North or East direction of the coordinate system.

4. **Enter Target Point:** Enter the PtID of the target. Press **Cont** to search for the point in the current job. Select the desired point or enter new coordinates and continue to the **Sight target point!** screen. Refer to "7.2.2 Measuring the Target Points", "Sight target point".

Measure Station Height

Optional for TS07.

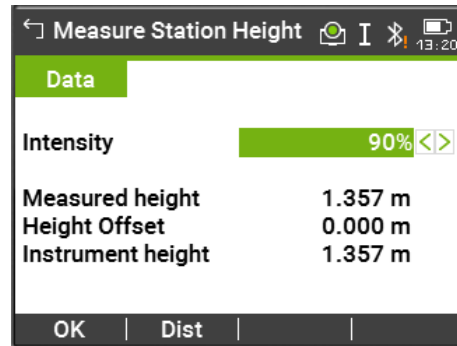

Key	Description
OK	The measured instrument height is displayed and used in the setup app.
Dist	To measure the instrument height.

Description of fields

Field	Option	Description
Intensity	Scroll bar	External influences and the surface conditions may require the adjustment of the intensity of the plummet. Adjust the intensity of the plummet using the navigation key. The laser can be adjusted in 20% steps as required.
Measured height	Display only	The height measured by the laser plummet.
Height Offset	Editable field	The entered value is added to the measured vertical distance.
Instrument height	Display only	The sum of Measured height and Height Offset .

7.2.2

Measuring the Target Points

Manual Angle Setting

Available for **Method: Ori. with Angle** only.

1. Enter the point ID and height of the target.

2. Measure the Hz angle and repeat the measurement in the other face:
↓ Face

3. Press **Set** to set the new orientation. The station setup is complete.

Sight target point

The remaining screens are available for all methods except Ori. with Angle and Local Resection.

Sight the target point and select **Meas**, or **Dist** and **Store** to measure to the target point.

Station Setup Result

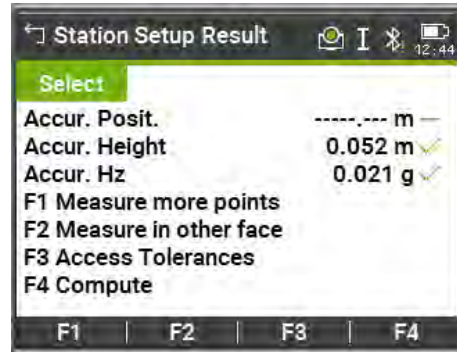

Key	Description
F1 Measure more points	To return to the Enter Target Point screen to measure more points.
F2 Measure in other face	To measure the same target point in another face.
F3 Access Tolerances	To change the accuracy limit values.
F4 Compute	To calculate and display the station coordinates.

Description of symbols

Symbol	Description
✓	Standard deviation/value within the defined limit
✗	Standard deviation/value exceeds the defined limit
—	No value calculated

Description of fields

Field	Option	Description
Accur. Posit.	Display only	If the standard deviation for position in East and North is calculated, a checkbox is displayed. The checkbox is checked if the calculated position is within the standard deviation limits or crossed if it is not.
Accur. Height	Display only	If the standard deviation for Height is calculated, a checkbox is displayed. The checkbox is checked if the calculated Height is within the standard deviation limits or crossed if it is not.
Accur. Hz	Display only	If the standard deviation for the Hz Orientation angle is calculated, a checkbox is displayed. The checkbox is checked if the calculated Hz Orientation is within the standard deviation limits or crossed if it is not.

7.2.3

Station Setup Results

Computation procedure

The computation of the station position is done via the **Method** selected in **Enter Station Data**.

If more than the minimum required measurements are performed, the procedure uses a least squares adjustment to determine the 3D position and averages orientation and height measurements.

- The original averaged face I and face II measurements are used for the computation process.
- All measurements are treated with the same accuracy, whether these are measured in single or dual face.
- Easting and Northing are determined by the least squares method, which includes standard deviation and improvements for horizontal direction and horizontal distances.
- The final height (**H**) is computed from averaged height differences based on the original measurements. For the methods **Ori. with Coord.** and **H-Trans** the height can be selected from old, average and new.
- The horizontal direction is computed with the original averaged face I and face II measurements and the final computed plan position.

Access

Press **F4 Compute** in the **Station Setup Result** screen.

Station Setup Result

This screen displays calculated station coordinates. The final computed results depend on the **Method** selected in **Enter Station Data**.

Standard deviations and residuals for accuracy assessments are provided.



If the instrument height was set to 0.000 in the setup screen, then the station height refers to the height of the tilting axis.

Result1	Result2
Station	Stn001
hi	1.500 m
East	0.000 m —
North	0.000 m —
Height	-0.152 m ✓
Hz	200.024 g ✓
Δ 	----- m

Add Pt | Resid. | Std.Dev | Set

Key	Description
Add Pt	To return to the Enter Target Point screen to enter the next point.
Resid.	To display residuals and to define the use of points as 1D, 2D or 3D. Refer to "Residuals".
Std.Dev	To display the standard deviation of the station coordinates and orientation.
Set	To set the station coordinates and/or orientation.

Description of fields



Field	Option	Description
Station	Display only	Current station ID.
hi	Display only	Current instrument height.
East	Display only	Calculated Easting coordinate of the station.
North	Display only	Calculated Northing coordinate of the station.
Height	Display only	Calculated Height coordinate of the station.
Hz	Display only	Current Hz angle with the new orientation.
Δ 	Display only	Available for Method: H-Trans or Ori. with Coord. with only 1 target point. Difference between the calculated and measured horizontal distance from the station to the design target.
Scale	Display only	Available for Method: Resection and Method: Res.Helm.. The calculated scale, if available.
Apply Scale	Display only	Yes or No . Select Yes to use the calculated scale as the system PPM scale. This overwrites any PPM scale previously set in the EDM Settings screens. Select No to keep the existing PPM value in the system and not apply the calculated scale.

Residuals

The screen displays the computed residuals for the horizontal and vertical distances and the horizontal direction.

Residual = Calculated value - Measured value.

Description of fields

Field	Option	Description
Use		Indicates if and how a target point is used in the station calculation.
	3D	Easting, Northing and Height coordinates are used for the calculation.
	2D	Easting and Northing coordinates are used for the calculation.
	1D	Only the height of the point is used for the calculation.
	Off	The point is not used for the calculation.
Δ Hz	Display only	Difference in direction
Δ 	Display only	Difference in horizontal distance
Δ 	Display only	Difference in height

Messages

The following are important messages or warnings that may appear.

Messages	Description
Selected point has invalid data! Check data and try again!	This message occurs if the selected target point has no Easting or Northing coordinate.
Max. 10 points supported!	10 points have already been measured and another point is selected. The system supports a maximum of 10 points.
No position computed due to bad data!	The measurements may not allow final station coordinates (Easting, Northings) to be computed.
No height computed due to bad data!	Either the target height is invalid or insufficient measurements are available to compute a final station height.
Face I-II limit exceeded! Re-measure point in both	This error occurs if a point was measured in one face and the measurement in the other face differs by more than the specified accuracy limit for the horizontal or vertical angle.
No data measured! Measure point again!	There is insufficient data measured to be able to compute a position or height. Either there are not enough points used or no distance measured.

Next step

Press **Set** to set the station coordinates and/or orientation and return to the **Apps Menu**.



- If a target point is measured several times in the same face, only the last valid measurement is used for computation.
- For **Method: Resection**:
 - The prism used for face I and face II measurements must be the same.
 - If different codes for face I and II are used, then the code of face I is used. If only face II is measured with a code, then the code of face II is assigned to the point.
- If the scale is calculated, then the standard deviation of the position with two targets is 0.0000. With flexible scale, the resection is fitted perfectly into the geometry without redundancy.



7.3

Surveying

Description

Survey is an app used for the measurement of an unlimited number of points. It includes pre-settings for the job, station and orientation prior to beginning a survey.

Access

1. Select **Apps** from the **Main Menu**.

2. Select **Survey** from the **Programs Menu**.

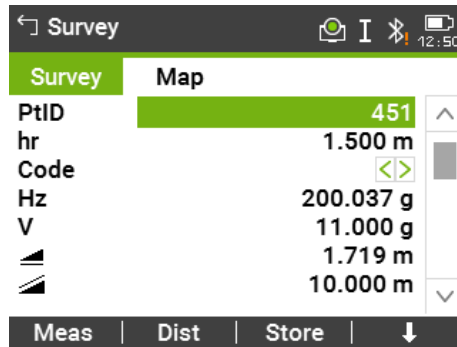
3. Complete app pre-settings. Refer to "6 Apps - Getting Started".

Survey



Key	Description
↓ Q-Code	To activate quick coding. Refer to "9.2 Quick Coding".
↓ IndivPt	To switch between individual and running point numbers.
↓ Manage	To view measurement data.

7.4

Setout

Description

Setout is an app used to place marks in the field at predetermined points. These predetermined points are the points to be staked. The points to be staked may already exist in a job on the instrument, or be manually entered. The app can continuously display differences, between current position and desired stake out position.

Stakeout modes

Points can be staked using different modes: Polar mode, Orthogonal to station mode and Cartesian mode.

Polar Stakeout mode

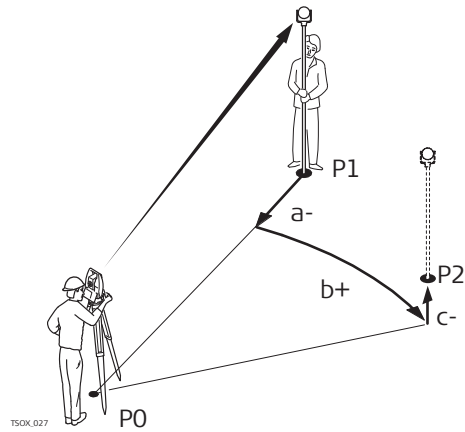

- P0 Instrument station
- P1 Current position
- P2 Point to be staked
- a- Δ : Difference in horizontal distance
- b+ Δ H: Difference in direction
- c+ Δ : Difference in height

Orthogonal to Station Stakeout mode

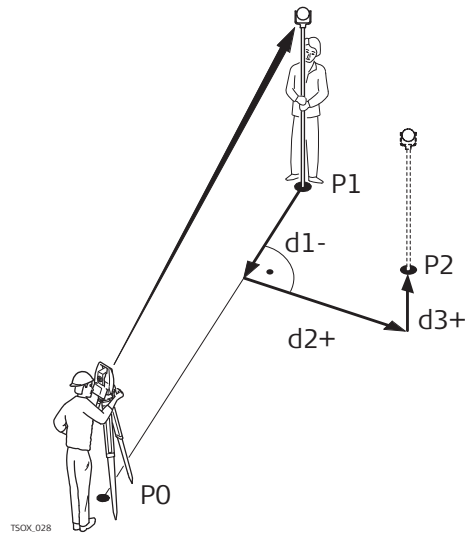

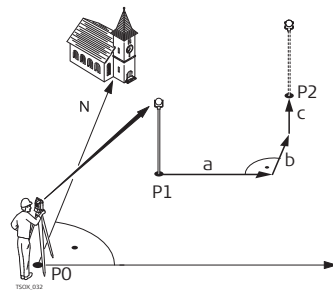

- P0 Instrument station
- P1 Current position
- P2 Point to be staked
- d1- Δ L: Difference in longitudinal distance
- d2+ Δ T: Difference in perpendicular distance
- d3+ Δ H: Difference in height

Cartesian Stakeout mode



- P0 Instrument station
- P1 Current position
- P2 Point to be staked
- a Δ E: Difference in Easting coordinate
- b Δ N: Difference in Northing coordinate
- c Δ H: Difference in height

Access

1. Select **Apps** from the **Main Menu**.

2. Select **Setout** from the **Programs Menu**.

3. Complete app pre-settings. Refer to "6 Apps - Getting Started".

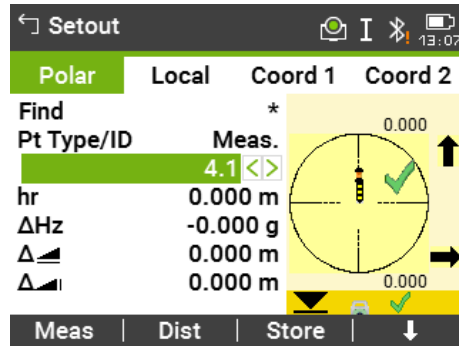
Description of fields

Field	Option	Description
Pre-/Suffix		Only used for the Setout app.
	Prefix	Adds the character entered for Identifier in front of the original point number of the point to be staked.
	Suffix	Adds the character entered for Identifier at the end of the original point number of the point to be staked.
	Off	The staked point is stored with the same point number as the point to be staked.
Identifier	Editable field	Only used for the Setout app. The identifier can be up to four characters and is added at the start, or end, of a point number of a point to be staked.
Setout Beep	On	The instrument beeps when the distance from the current position to the point to be staked is ≤ 0.5 m. The closer the prism is to the point to be staked the faster the beeps will be.
	Off	Beep is deactivated.
Filter	Off	No filter is active
	Nearest	Searches the job for points close to the current position. The points are selected as the points to be staked. After staking and storing the first nearest point, the next nearest point is suggested for staking out. The app algorithm sorts the points according to the minimum walking distance in all directions to each point.
	Radius	Shows points within the defined radius from a particular point. The radius is the horizontal distance.
	Ptld Range	Shows points with point IDs between the entered start and end ID.
Centre Point	Editable field	The point to which the radius is applied. Available for Filter: Radius .
Radius	Editable field	The radius of the circle within which the points are shown. Available for Filter: Radius .
From	Editable field	The first point to be displayed. Available for Filter: Ptld Range .
To	Editable field	The last point to be displayed. Available for Filter: Ptld Range .



Key	Description
↓ B&Dist	To enter the direction and horizontal distance to a stake out point.
↓ Manual	To manually enter coordinates of a point.
↓ Survey	To switch to the Survey app. Press ESC to return to the Set-out screen.

☞ Refer to "3.8 Graphic Symbols" for a description of the graphic elements.

Description of fields

Field	Option	Description
Find	Display only	Available when no filter is applied. Value for Point ID search. After entry, the firmware searches for matching points, and displays these in PtID : If a matching point doesn't exist the pointsearch screen opens.
Radius	Selectable list	Available when the point filter is active. the defined radius from a particular point.
Range	Display only	Available when the range is active. The defined range of points. For long point IDs, the last digits are be shown and the first digits are cut.
Pt Type/ID	Display only	Displays the type of point selected. <ul style="list-style-type: none"> • Fixpt., or • Meas.
ΔHz	Display only	Angle offset: Positive if stake out point is to the right of the measured point.
Δ	Display only	Horizontal offset: Positive if stake out point is further away than the measured point.
Δ	Display only	Height offset: Positive if stake out point is higher than the measured point.
ΔL	Display only	Longitudinal offset: Positive if stake out point is further away than the measured point.
ΔT	Display only	Perpendicular offset: Positive if stake out point is to the right of the measured point.
ΔH	Display only	Height offset: Positive if stake out point is higher than the measured point.

Field	Option	Description
ΔE	Display only	Easting offset: Positive if stake out point is to the right of the measured point.
ΔN	Display only	Northing offset: Positive if stake out point is further away than the measured point

7.5

Reference Line

7.5.1



Overview

Description

Reference Line is an app that facilitates the easy stake out or checking of lines, for example, for buildings, sections of road, or simple excavations. It allows the user to define a reference line and then complete the following tasks with respect to that line:

- Line & offset
- Stake out points
- Grid stake out
- Line segmentation stake out

Access

1. Select **Apps** from the **Main Menu**.

2. Select **Ref.Line** from the **Programs Menu**.

3. Complete app pre-settings. Refer to "6 Apps - Getting Started".

Next step

Define the base line for the reference line.

7.5.2

Defining the Base Line

Description

A reference line can be defined by referencing a known base line. The reference line can be offset either longitudinally, in parallel or vertically to the base line, or be rotated around the first base point as required. Furthermore the reference height can be selected as the first point, second point or interpolated along the reference line.

Define the base line

The base line is fixed by two base points. All points can be either measured, manually entered, or selected from the memory.

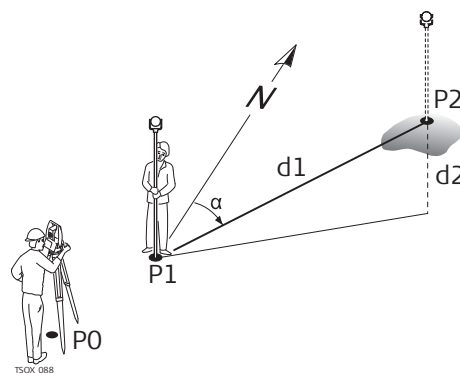

Base line

- P0 Instrument station
- P1 Start point
- P2 End point
- d1 Known distance
- d2 Difference in height
- α Azimuth

Define the base line by measuring or selecting the start and end points of the line.

Next step

After defining the base line the **Reference Line - Info** screen will appear for defining the reference line.

7.5.3

Defining the Reference Line

Description

The base line can be offset from, either longitudinally, in parallel or vertically, or be rotated around the first base point. This new line created from the offsets is called the reference line. All measured data refers to the reference line.

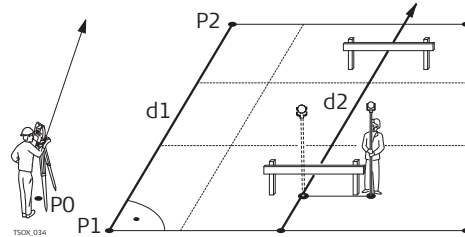

- P0 Instrument station
- P1 Start point
- P2 End point
- d1 Base line
- d2 Reference line

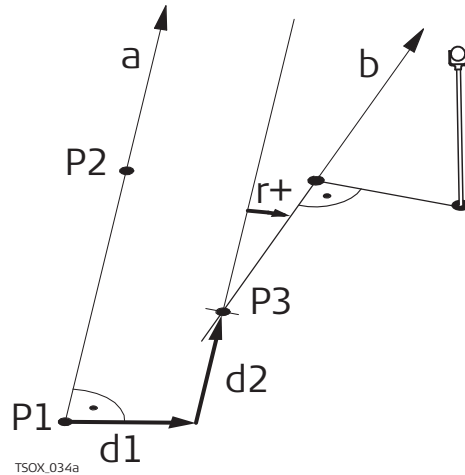

- P1 Base point
- P2 Base point
- a Base line
- d1 Parallel offset
- d2 Longitudinal offset
- P3 Reference point
- r+ Rotation parameter
- b Reference line

Access

After completing the measurements required for defining the base line, the **Reference Line - Info** screen will appear.

Reference Line - Info

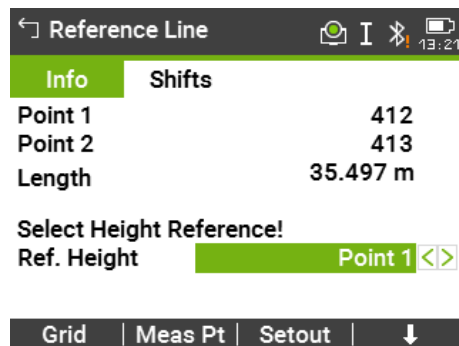

Key	Description
Grid	To stake out a grid relative to the reference line.
Meas Pt	To measure Line & Offset.
Setout	To stake out points orthogonal to the reference line.

Key	Description
↓ NewBL	To define a new base line.
↓ Shift=0	To reset all offset values to 0.
↓ Segment	To subdivide a reference line into a definable number of segments and stake out the new points on the reference line.

Description of fields

Field	Option	Description
Length	Display only	Length of the base line.
Ref. Height	Point 1	Height differences are computed relative to the height of the first reference point.
	Point 2	Height differences are computed relative to the height of the second reference point.
	Interpolated	Height differences are computed along the reference line.
	No Height	Height differences are not computed or shown.
Offset	Display only	Parallel offset of the reference line relative to the base line (P1-P2). Available on page 2/2 for TS03 or on page Shifts for TS07. Positive values are to the right of the base line.
Line	Display only	Longitudinal offset of the start point, reference point (P3), of the reference line in the direction of base point 2. Available on page 2/2 for TS03 or on page Shifts for TS07. Positive values are towards base point 2.
Height	Display only	Height offset of the reference line to the selected reference height. Available on page 2/2 for TS03 or on page Shifts for TS07. Positive values are higher than the selected reference height.
Rotate	Display only	Rotation of the reference line clockwise around the reference point (P3). Available on page 2/2 for TS03 or on page Shifts for TS07.

Next step

Select a softkey option, **Meas Pt**, **Setout** or ↓ **Segment**, to proceed to a sub-app.

7.5.4

Measure Line & Offset

Description

The Measure Line & Offset subapp calculates from measurements or coordinates, longitudinal offsets, parallel offsets and height differences of the target point relative to the reference line.

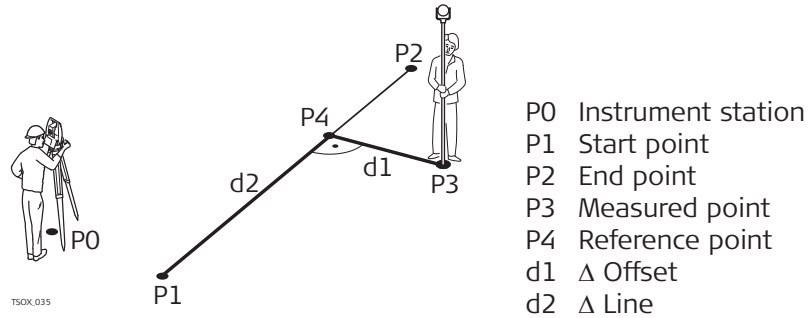

Example of height difference relative to first reference point

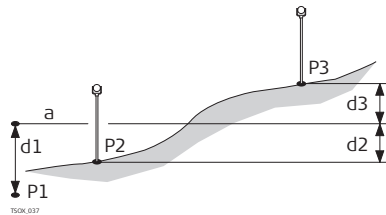

- P1 Start point
- P2 Target point
- P3 Target point
- a Reference height
- d1 Height difference between start point and the reference height
- d2 Height difference between P2 and the reference height
- d3 Height difference between P3 and the reference height

Access

Press **Meas** in the **Reference Line - Info** screen.

Measure line & offset

Description of fields

Field	Description
ΔL	Calculated distance longitudinal to the reference line.
ΔO	Calculated distance perpendicular from the reference line.
ΔH	Calculated height difference relative to the defined reference height.

Next step

- Either, press **Meas** to measure and record.
- Or, press **↓ Back** to return to the **Reference Line - Info** screen.

7.5.5

Stakeout

Description

The stakeout subapp calculates the difference between a measured point and the calculated point. The orthogonal (ΔL , ΔO , ΔH) and polar (ΔHz , $\Delta \sphericalangle$, $\Delta \sphericalangle$) differences are displayed.

Example orthogonal stakeout

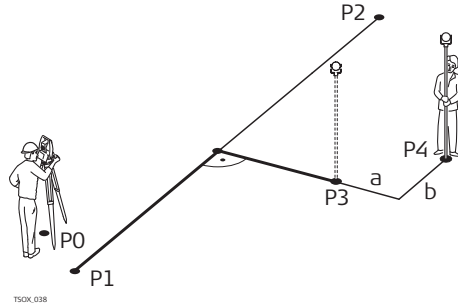

- P0 Instrument station
- P1 Start point
- P2 End point
- P3 Stake out point
- P4 Measured point
- a Δ Parallel offset
- b Δ Longitudinal offset

Access

Press **Setout** from the **Reference Line - Info** screen.

Orthogonal stakeout

Enter the stake out elements for the target points to be staked out relative to the reference line.

Description of fields

Field	Option	Description
Line	Display only	Longitudinal offset: Positive if stake out point is further away from the reference line.
Offs	Display only	Perpendicular offset: Positive if stake out point is to the right of the reference line.
Height	Display only	Height offset: Positive if stake out point is higher than the reference line.

Next step

Press **Cont** to proceed to measurement mode.

Reference Line - Set-out

The signs for the distance and angle differences are correction values (required minus actual). The arrows indicate the direction to move to get to the stake out point.

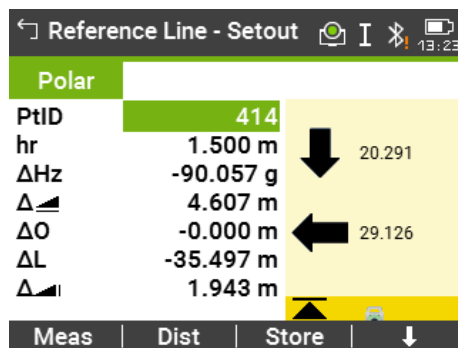

Key	Description
Next Pt	To add the next point to be staked out.

Description of fields

Field	Description
ΔH_z	Horizontal direction from the measured point to the stake out point. Positive if the telescope must be turned clockwise to the stake out point.
ΔL	Longitudinal distance from the measured point to the stake out point. Positive if stake out point is further away than the measured point.
ΔO	Perpendicular distance from the measured point to the stake out point. Positive if stake out point is to the right of the measured point.
$\Delta \nearrow$	Horizontal distance from the measured point to the stake out point. Positive if the stake out point is further away than the measured point.
$\Delta \nwarrow$	Height difference from the measured point to the stake out point. Positive if the stake out point is higher than the measured point.

Next step

- Either, press **Meas** to measure and record.
- Or, press **↓ Back** to return to the **Reference Line - Info** screen.

7.5.6

Grid Stakeout

Description

The Grid subapp calculates and displays the stake out elements for the points on the grid, orthogonal (ΔL , ΔO , ΔH) and polar (ΔH_z , $\Delta \nearrow$, $\Delta \nwarrow$). The grid is defined without boundaries. It can be extended over the first and second base points of the reference line.

Example Grid Stakeout

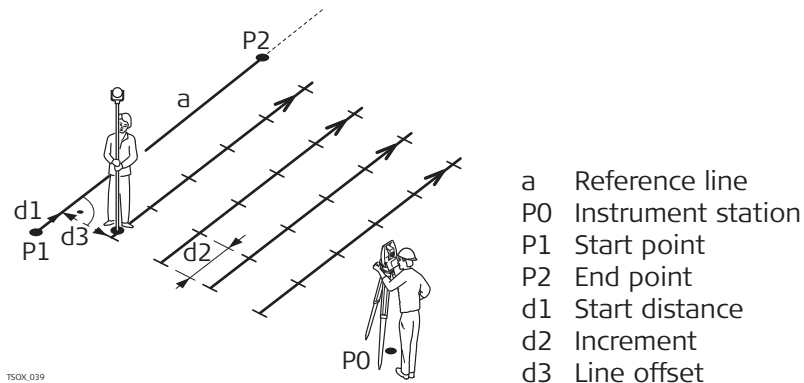

Access

Press **Grid** from the **Reference Line - Info** screen.

Grid definition

Enter the chainage and the increment of grid points in length and cross direction of the reference line.

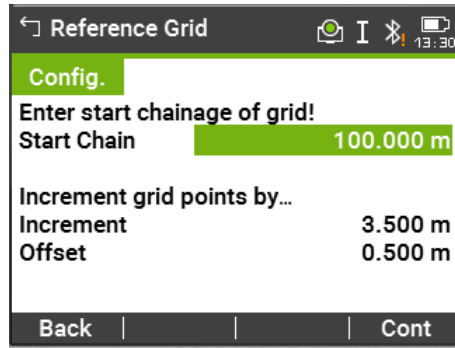

Description of fields

Field	Options	Description
Start Chain	Editable field	Distance from the reference line start point to the beginning grid start point.
Increment	Editable field	Length of incrementation.
Offset	Editable field	Offset distance from the reference line.

Next step

Press **Cont** to proceed to the **Reference Grid - Setout** screen.

Reference Grid - Setout

The signs for the distance and angle differences are correction values (required minus actual). The arrows indicate the direction to move to get to the stake out point.

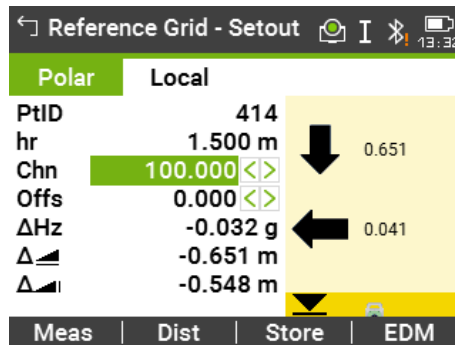

Description of fields

Field	Option	Description
Chn	Selectable field	The chainage of the grid stakeout point.
Offs	Selectable field	Offset increment values. The stake out point is to the right of the reference line.
ΔHz	Display only	Horizontal direction from the measured point to stake out point. Positive if the telescope must be turned clockwise to the stake out point.

Field	Option	Description
$\Delta \triangleleft$	Display only	Horizontal distance from the measured point to stake out point. Positive if the stake out point is further away than the measured point.
$\Delta \triangleup$	Display only	Height difference from the measured point to the stake out point. Positive if the stake out point is higher than the measured point.
Line	Display only	Grid increment values. The stake out point is in the direction from the first to the second reference point.
ΔL	Display only	Longitudinal distance from the measured point to the stake out point. Positive if stake out point is further away than the measured point.
ΔO	Display only	Perpendicular distance from the measured point to the stake out point. Positive if stake out point is to the right of the measured point.

Next step

- Either, press **Meas** to measure and record.
- Or, press **ESC** to return to the **Enter start chainage of grid!** screen and from there, press **Back** to return to the **Reference Line - Info** screen.

7.5.7

Line Segmentation

Description

The line segmentation subapp calculates and displays the stake out elements for the points along the line, orthogonal (ΔL , ΔO , ΔH) and polar (ΔHz , $\Delta \triangleleft$, $\Delta \triangleup$). Line Segmentation is limited to the reference line, between the defined start and end points of the line.

Example Line Segmentation Stakeout

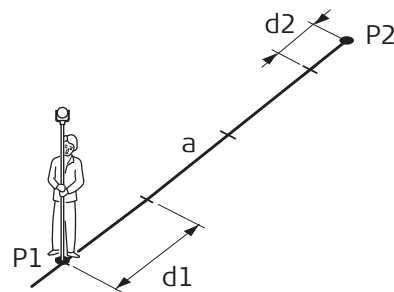

TSOX_040



- P0 Instrument station
- P1 First reference point
- P2 Second reference point
- a Reference line
- d1 Segment length
- d2 Misclosure

Access

Press **↓ Segment** from the **Reference Line - Info** screen.

Segment Definition

Enter either the number of segments, or the length of segments and define how the remaining line length is treated. This misclosure can be placed at the start, at the end, at the start and the end or distributed evenly along the line.

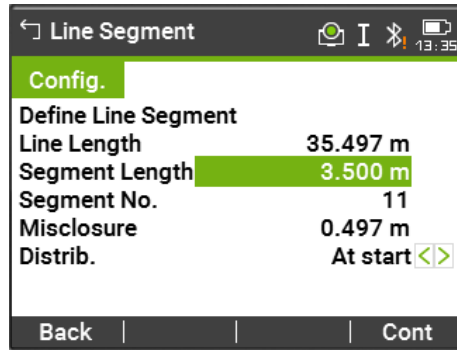

Description of fields

Field	Option	Description
Line Length	Display only	Calculated length of the defined reference line.
Segment Length	Display only	Length of each segment. Updated automatically if the number of segments is entered.
Segment No.	Display only	Number of segments. Updated automatically if the segment length is entered.
Misclosure	Display only	Any remaining line length after segment length has been entered.
Distrib.		Method of misclosure distribution.
	None	All of the misclosure will be placed after the last segment.
	At start	All of the misclosure will be placed before the first segment.
	Equal	The misclosure will be equally distributed between all segments.
	StartEnd	The misclosure is equally distributed at the start and at the end of the segment line.

Next step

Press **Cont** to proceed to the **Line Segment - Setout** screen.

Line Segment - Setout

The signs for the distance and angle differences are correction values (required minus actual). The arrows indicate the direction to move to get to the stake out point.

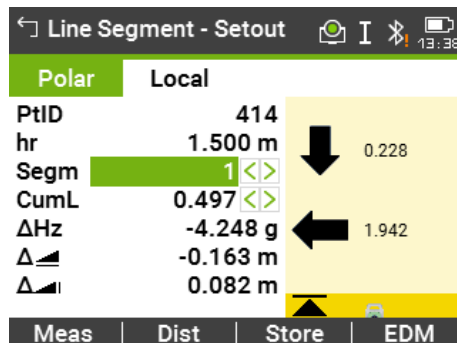

Description of fields

Field	Option	Description
Segm	Selectable list	Segment number. Includes the misclosure segment, if applicable.
CumL	Selectable list	Cumulation of the segment lengths. Changes with the current number of segments. Includes the misclosure segment length if applicable.
ΔHz	Display only	Horizontal direction from the measured point to the stake out point. Positive if the telescope must be turned clockwise to the stake out point.
Δ	Display only	Horizontal distance from the measured point to the stake out point. Positive if the stake out point is further away than the measured point.
Δ	Display only	Height difference from the measured point to the stake out point. Positive if the stake out point is higher than the measured point.
ΔL	Display only	Longitudinal distance from the measured point to the stake out point. Positive if stake out point is further away than the measured point.
ΔO	Display only	Perpendicular distance from the measured point to the stake out point. Positive if stake out point is to the right of the measured point.

Messages

The following are important messages or warnings that may appear.

Messages	Description
Baseline too short!	Base line is shorter than 1 cm. Choose base points such that the horizontal separation of both points is at least 1 cm.
Coordinates invalid!	No coordinates or invalid coordinates for a point. Ensure that points used have at least Easting and Northing coordinates.
Recording to interface!	Data Output is set to Bluetooth in the Data Settings Menu . To be able to successfully start reference line, Data Output must be set to Internal Memory .

Next step

- Either, press **Meas** to measure and record.
- Or, press **ESC** to return to the **Define Line Segment** screen and from there, press **Back** to return to the **Reference Line** screen.
- Or, continue selecting **ESC** to exit the app.

7.6

Reference Arc

7.6.1



Overview

Description

The Reference Arc app allows the user to define a reference arc and then complete the following tasks with respect to the arc:

- Line & offset
- Stakeout (Point, Arc, Chord, Angle)

Access

1. Select **Apps** from the **Main Menu**.

2. Select **Ref.Arc** from the **Programs Menu**.

3. Complete app pre-settings. Refer to "6 Apps - Getting Started".

Next step

Define the reference arc.

7.6.2

Defining the Reference Arc

Description

The reference arc can be defined by;

- a center point and start point,
- a start point, end point, and radius, or
- by three points.

All points can be either measured, manually entered, or selected from the memory.

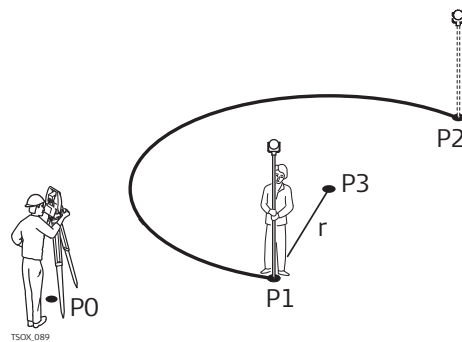

Reference arc

- P0 Instrument station
- P1 Start point
- P2 End point
- P3 Center point
- r Radius of arc



All arcs are defined in a clockwise direction and all calculations are made in two dimensions.

Access

1. Select **Ref.Arc**.

2. Select the method to define the arc by:
 - **Centre & Start**
 - **Start, End & Radius**
 - **3 Points**

Reference Arc - Measure to start point

Description of fields

Field	Option	Description
Start Pt	Editable field	Point ID of the start point.
Centre Pt	Editable field	Point ID of the center point.
Mid Pt	Editable field	Point ID of the mid point.
End Pt	Editable field	Point ID of the end point.
Radius	Editable field	Radius of the arc. A positive value, for example 100 m, is for a clockwise direction of the reference arc. A negative value, for example -100 m, is for an anticlockwise direction of the reference arc.

Radius: 100 m Clockwise	Radius: -100 m Anti-clockwise	Legend
----------------------------	----------------------------------	--------

Solution 1



- P1 Start point
- P2 End point
- P3 Centre point 1
- P4 Centre point 2
- d Direction of the arc

Solution 2

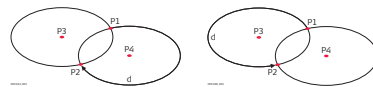

- P1 End point
- P2 Start point
- P3 Centre point 1
- P4 Centre point 2
- d Direction of the arc

Solution 1

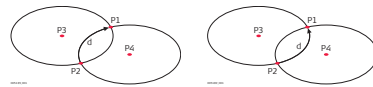

Solution 2

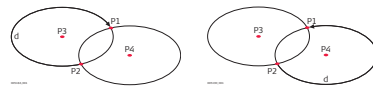

Next step

After defining the reference arc the **Reference Arc - Info** screen will appear.

Reference Arc - Info



In certain cases, there are two mathematical solutions, as shown in the screenshot. In the subapps Measure and Stakeout, the appropriate solution can be selected.

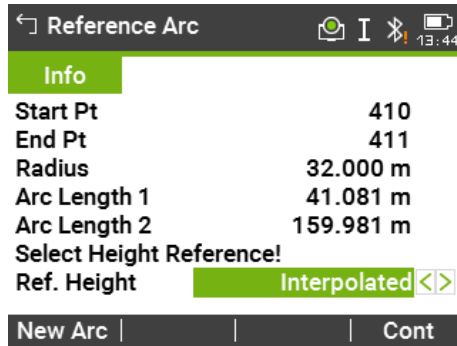

Description of fields

Field	Option	Description
Ref. Height		Depending on the task chosen this parameter determines the design height. <ul style="list-style-type: none"> When measuring to a line, it affects the height difference value. When staking, it affects the delta height value.
	Start Point	Heights are computed relative to the height of the starting point of the line.
	End Point	Heights are computed relative to the height of the end point of the line.
	Interpolated	Heights are computed along the line.
	No Height	Heights are ignored

Next step

Select **Cont** and then **Meas Pt** or **Setout** to proceed to a subapp.

7.6.3

Measure Line & Offset

Description

The Measure Line & Offset subapp calculates from measurements or coordinates, longitudinal and orthogonal offsets and height differences of the target point relative to the reference arc.

Example reference arc - measure line & offset

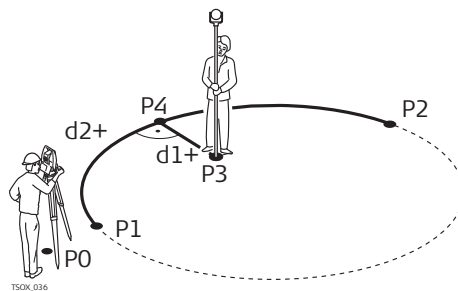

- P0 Instrument station
- P1 Start point
- P2 End point
- P3 Measured point
- P4 Reference point
- $d1+\Delta$ Offset
- $d2+\Delta$ Line

Access

Press **Meas** from the **Reference Arc - Info** screen.

Measure Line & Offset

Description of fields

Field	Option	Description
ΔL	Display only	Calculated distance longitudinal to the reference arc.
ΔO	Display only	Calculated distance perpendicular from the reference arc.
ΔH	Display only	Calculated height difference relative to the start point of reference arc.

Next step

- Either, press **Meas** to measure and record.
- Or, press **↓ Back** to return to the **Reference Arc - Info** screen.

7.6.4

Stakeout

Description

The Stakeout subapplication calculates the difference between a measured point and the calculated point. The Reference Arc app supports four ways to stake out:

- Stake out point
- Stake out arc
- Stake out chord
- Stake out angle

Stake out point

To stake out a point by entering a line and an offset value.

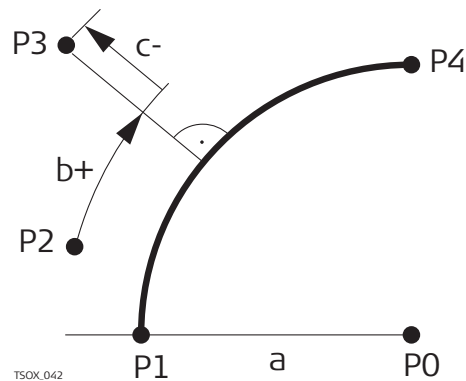

- P0 Center point of arc
- P1 Start point of arc
- P2 Measured point
- P3 Stake out point
- P4 End point of arc
- a Radius of arc
- b+ Line offset
- c- Perpendicular offset

Stake out arc

To stake out a series of equidistant points along the arc.

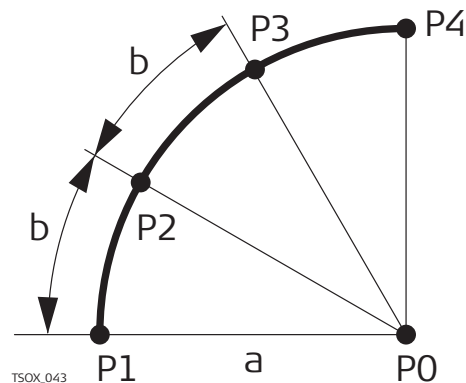

- P0 Center point of arc
- P1 Start point of arc
- P2 Stake out point
- P3 Stake out point
- P4 End point of arc
- a Radius of arc
- b Arc length

Stake out chord

To stake out a series of equidistant chords along the arc.

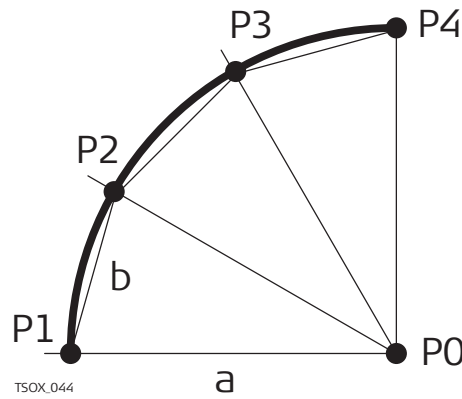

- P0 Center point of arc
- P1 Start point of arc
- P2 Stake out point
- P3 Stake out point
- P4 End point of arc
- a Radius of arc
- b Chord length

Stake out angle

To stake out a series of points along the arc defined by the angle segments from the center point of the arc.

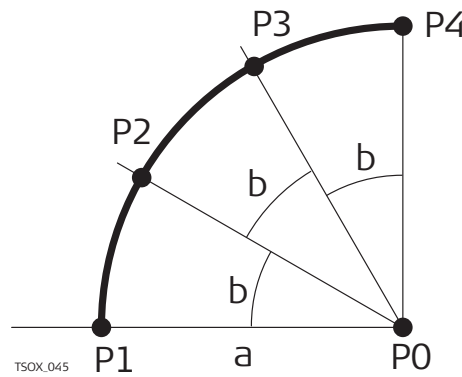

- P0 Center point of arc
- P1 Start point of arc
- P2 Stake out point
- P3 Stake out point
- P4 End point of arc
- a Radius of arc
- b Angle

Access

1. Press **Setout** from the **Reference Arc - Info** screen.
2. Select one of the four methods of stake out available.

Stake out point, arc, chord or angle

Enter the stake out values. Press **CentreP** to stake the arc centre point.

Description of fields

Field	Option	Description
Line	Editable field	For stake out arc, chord and angle: Longitudinal offset from the reference arc. This is calculated by the arc length, chord length or angle and the selected misclosure distribution. For stake out point: Longitudinal offset from the reference arc.
Offset	Editable field	Perpendicular offset from the reference arc.
Distrib.		For stakeout arc: Method of misclosure distribution. If the entered arc length is not an integer of the whole arc, there will be a misclosure.

Field	Option	Description
	None	All of the misclosure will be added to the last arc-section.
	Equal	The misclosure will be equally distributed between all sections.
	Start Arc	All of the misclosure will be added to the first arc-section.
	Start & End	The misclosure will be added half to the first arc-section and half to the last arc-section.
Arc Length	Editable field	For stakeout arc: The length of the arc-segment to stake out.
Chord Length	Editable field	For stakeout chord: The length of the chord to stake out.
Angle	Editable field	For stake out angle: The angle around the center point of the arc, of the points to be staked out.

Next step

Press **Cont** to proceed to measurement mode.

Reference Arc - Set-out

The signs for the distance and angle differences are correction values (required minus actual). The arrows indicate the direction to move to get to the stake out point.

 To allow a better visibility, for example if the arc is very long and the target close to the line, the scale for x and y can be different in the graphic. If the instrument is far off the arc, the instrument in the graphic is placed in the corner and marked red/grey.

To define the next point to be staked out, type in a point ID, the reflector height, the distance along the arc and an offset.

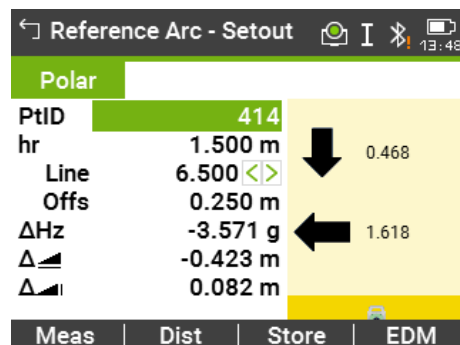

Description of fields

Field	Option	Description
ΔH_z	Display only	Horizontal direction from the measured point to the stake out point. Positive if the telescope must be turned clockwise to the stake out point.
$\Delta \triangleleft$	Display only	Horizontal distance from the measured point to the stake out point. Positive if the stake out point is further away than the measured point.
$\Delta \triangleleft \uparrow$	Display only	Height difference from the measured point to the stake out point. Positive if the stake out point is higher than the measured point.

Next step

- Either, press **↓ Meas** to measure and record.
- Or, press **↓ Back** to return to the **Reference Arc - Info** screen.
- Or, continue selecting **ESC** to exit the app.

7.7

Reference Plane

Description

Reference Plane is an app used to measure points relative to a reference plane. It can be used for the following tasks:

- Measuring a point to calculate and store the perpendicular offset to the plane.
- Calculating the perpendicular distance from the intersection point to the local X- and Z-axis. The intersection point is the footprint point of the perpendicular vector from the measured point through the defined plane.
- Viewing, storing and staking out the coordinates of the intersection point.

A reference plane is created by measuring three points on a plane. These three points define a local coordinate system:

- The first point is the origin of a local coordinate system.
- The second point defines the direction of the local Z-axis.
- The third point defines the plane.

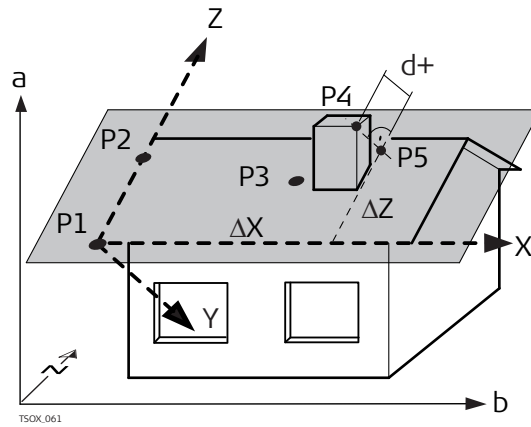

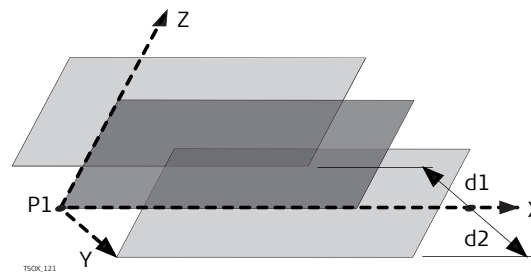

- X X-axis of local coordinate system.
- Y Y-axis of local coordinate system.
- Z Z-axis of local coordinate system.
- P1 First point, origin of local coordinate system.
- P2 Second point
- P3 Third point
- P4 Measured point. This point is probably not located on the plane.
- P5 Intersection point of the perpendicular vector from P4 to the defined plane. This point is definitely located on the defined plane.
- d+ Perpendicular distance from P4 to the plane.
- ΔX Perpendicular distance from P5 to the local Z-axis.
- ΔZ Perpendicular distance from P5 to the local X-axis.

The perpendicular distance to the plane can be positive or negative.



- P1 Origin of plane
- X X-axis of plane
- Y Y-axis of plane
- Z Z-axis of plane
- d1 Positive offset
- d2 Negative offset

Access

1. Select **Apps** from the **Main Menu**.

2. Select **Ref.Plane** from the **Programs Menu**.

3. Complete app pre-settings. Refer to "6 Apps - Getting Started".

Measure plane and target points

- Once the plane has been defined by three points, the **Measure target point!** screen appears.
- Measure and record the target point. The results are displayed in the **Reference Plane Result** screen.

Reference Plane Result

The screenshot shows the 'Reference Plane Result' screen with the following data:

Result	
Int.PtID:	441
Offset	0.693 m
ΔX	2.191 m
ΔZ	5.806 m
East	30.101 m
North	4.901 m
Height	7.153 m

Navigation options at the bottom: NewTgt | Setout | NewPlan | End

Key	Description
NewTgt	To record and save the intersection point and to proceed to measure a new target point.
Setout	To display stake out values and a graphic for the intersection point. Refer to "3.8 Graphic Symbols" for an explanation of the graphic symbols.
NewPlan	To define a new reference plane.

Description of fields

Field	Option	Description
Int.PtID	Display only	Point ID of the intersection point, the perpendicular projection of the target point on the plane.
Offset	Display only	Calculated perpendicular distance between target point and plane (intersection point).
ΔX	Display only	Perpendicular distance from the intersection point to the local Z-axis.
ΔZ	Display only	Perpendicular distance from the intersection point to the local X-axis.
East	Display only	Easting coordinate of the intersection point.
North	Display only	Northing coordinate of the intersection point.
Height	Display only	Height of the intersection point.

7.8

Tie Distance

Description

Tie Distance is an app used to compute slope distance, horizontal distance, height difference and azimuth of two target points which are either measured, selected from the memory, or entered using the keypad.

Tie distance methods

The user can choose between two different methods:

- **Polygonal:** P1-P2, P2-P3, P3-P4.
- **Radial:** P1-P2, P1-P3, P1-P4.

Polygonal method

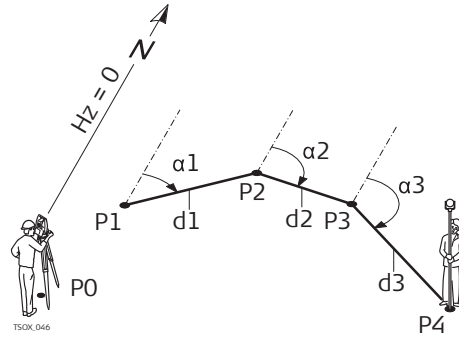

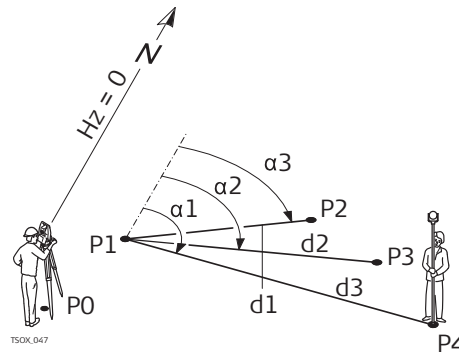

- P0 Instrument station
- P1-P4 Target points
- d1 Distance from P1-P2
- d2 Distance from P2-P3
- d3 Distance from P3-P4
- α_1 Azimuth from P1-P2
- α_2 Azimuth from P2-P3
- α_3 Azimuth from P3-P4

Radial method



- P0 Instrument station
- P1-P4 Target points
- d1 Distance from P1-P2
- d2 Distance from P1-P3
- d3 Distance from P1-P4
- α_1 Azimuth from P1-P4
- α_2 Azimuth from P1-P3
- α_3 Azimuth from P1-P2

Access

1. Select **Apps** from the **Main Menu**.

2. Select **Tie Dist.** from the **Programs Menu**.

3. Complete app pre-settings. Refer to "6 Apps - Getting Started".
4. Select **Polygonal** or **Radial**.

Tie distance measurements

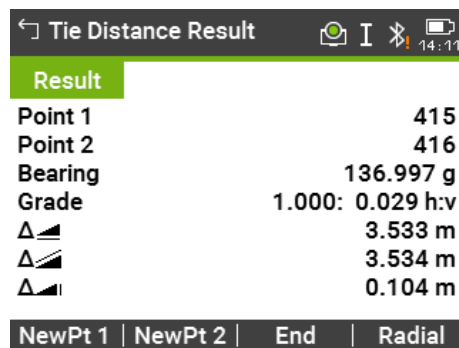

After completing the measurements required, the **Tie Distance Result** screen will appear.

Tie Distance Result - Polygonal method



Key	Description
NewPt 1	To calculate an additional line. The app starts again at point 1.
NewPt 2	To set point 2 as the starting point of a new line. A new point 2 must be measured.
Radial	To switch to radial method.

Description of fields

Field	Option	Description
Bearing	Display only	Azimuth between point 1 and point 2.
Grade	Display only	Grade between point 1 and point 2.
Δ 	Display only	Slope distance between point 1 and point 2.
Δ 	Display only	Horizontal distance between point 1 and point 2.
Δ 	Display only	Height difference between point 1 and point 2.

Next step

Press **ESC** to exit the app.

7.9

Area & DTM Volume

7.9.1

Overview

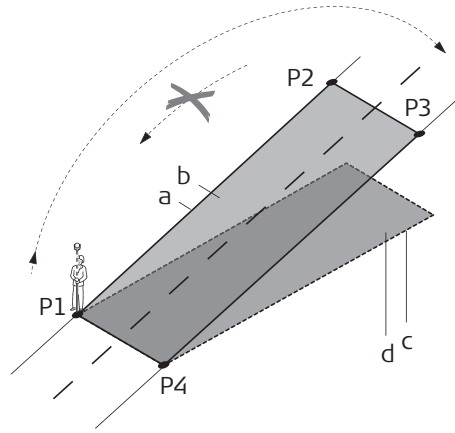

Description

Area & DTM Volume is an app used to compute online areas to a maximum of 50 points connected by straights. The target points have to be measured, selected from memory, or entered via the keypad in a clockwise direction. The calculated area is projected onto the horizontal plane (2D) or projected onto the sloped reference plane defined by three points (3D). Furthermore a volume can be computed by automatically creating a digital terrain model (DTM). Area division is also possible for 2D areas.









- P0 Instrument station
- P1 Target point which defines the sloped reference plane
- P2 Target point which defines the sloped reference plane
- P3 Target point which defines the sloped reference plane
- P4 Target point
- a Perimeter (3D), polygonal length from the start point to the current measured point of the area (3D)
- b Area (3D), projected onto the sloped reference plane
- c Perimeter (2D), polygonal length from the start point to the current measured point of the area (2D)
- d Area (2D), projected onto the horizontal plane

Access

1. Select **Apps** from the **Main Menu**.

2. Select **Area&Vol.** from the **Programs Menu**.

3. Complete app pre-settings. Refer to "6 Apps - Getting Started".
4. Select an **Area&Vol.** subapp from the **Area & DTM Volume Main Menu**.

Map contents

The graphic on the **Polar** page shows the area projected onto the reference plane. The points used for defining the reference plane are indicated by:

Icon	Description
	Measured point
	Measured point active
	Manually entered point
	Manually entered point active
	Station
	Station active
	Points defining the reference plane

The graphic on the **Plot** page shows additionally the area projected onto the reference plane, the horizontal distance between the points the perimeter and the area.

7.9.2

2D / 3D Area

Graphical representation

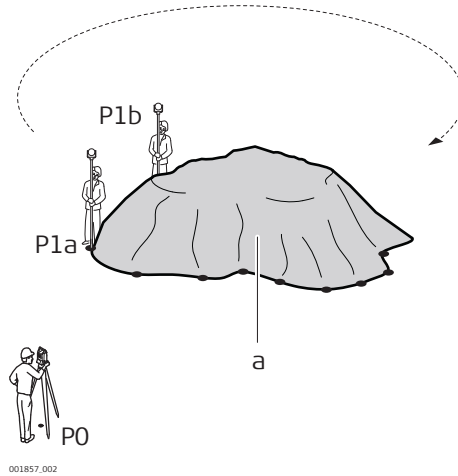

P0 Instrument station
 P1a.. Boundary point
 a Volume as calculated by the triangulated irregular network (TIN)

2D / 3D Area

1. Measure or select existing points to define the area.
2. The 2D and 3D areas are calculated automatically and displayed once three points have been measured or selected.

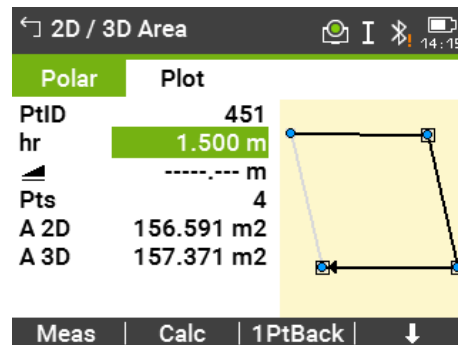

Key	Description
Calc	To display and record additional results.
1PtBack	To undo measurement or selection of the previous point.

Description of fields

Field	Option	Description
A 2D	Display only	Two-dimensional area calculated by projection onto a horizontal plane.
A 3D	Display only	Three-dimensional area calculated by projection onto an automatically defined horizontal reference plane. The 3D area is calculated based on the following: <ul style="list-style-type: none"> The system will use the three points which cover the largest area. If there are two or more equal largest areas, the system will use the area with the shortest perimeter. If the largest areas have equal perimeters, the system will use the area with the last measured point.

Next step

Press **Calc** to calculate area and volume and proceed to the **2D / 3D Area Results** screen.

In the **2D / 3D Area Results** screen.

- View the area in ha and m² as well as the perimeter of the area.
- Press **NewArea** to define a new area.
- Or, press **End** to exit the app.

7.9.3

Area to Reference Plane

Area to Reference Plane

- Measure three new points or select three existing points to define the reference plane.
- Then measure or select existing points to define the area.
- The 2D and 3D areas are calculated automatically and displayed once three points have been measured or selected.

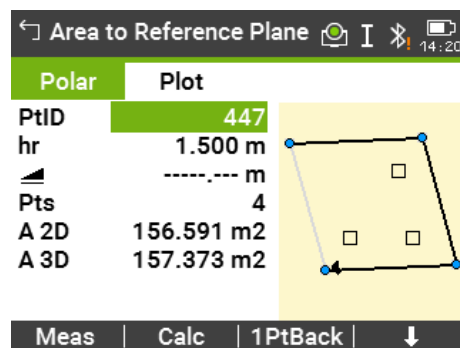

Key	Description
Calc	To display and record additional results.
1PtBack	To undo measurement or selection of the previous point.

Description of fields

Field	Options	Description
A 2D	Display only	Two-dimensional area calculated by projection onto a horizontal plane.
A 3D	Display only	Three-dimensional area calculated by projection onto the manually defined reference plane. The 3D area is calculated automatically after measuring or selecting three points.

Next step

1. Press **Calc** to calculate area and volume and proceed to the **Area to Ref. Plane Results** screen.
2. In the **Area to Ref. Plane Results** screen.
 - View the area in ha and m² as well as the perimeter of the area.
 - Press **NewArea** to define a new area.
 - Or, press **End** to exit the app.

7.9.4

DTM Volume



The breakline points must be located within the boundary of the defined area.

DTM Volume

1. Measure or select existing points to define the area.
2. The 2D and 3D areas are calculated automatically and displayed once three points have been measured or selected.
3. Press **Calc**.
4. Press **@BLPt**.
5. Measure or select points on the breakline. These points are then used to calculate a volume.
6. Press **Calc**.

← DTM Volume Results  14:40

2D	3D	Volume
Pts		8
Area	0.016 ha	
Area	156.591 m ²	
Per.	50.695 m	
DTM-V	57.119 m ³	

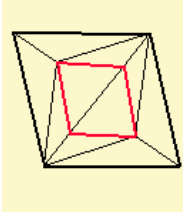

NewArea | New BL | @BLPt | End

← Calculate Volume & Weight  14:41

2D	3D	Volume
DTM-Grd.Area		157.710 m ²
BreakLn Area		39.307 m ²
DTM-Volume I		57.119 m ³
Swell Factor		1.200
DTM-Volume II		68.543 m ³
Weight Factor		t/m ³
Weight		0.000 t

NewArea | New BL | @BLPt | End

Key	Description
NewArea	To define a new area.
New BL	To define a new breakline area and calculate a new volume.
@BLPt	To add a new point to the existing breakline area and calculate a new volume.
End	To exit the app.

Description of fields

Field	Option	Description
A 2D	Display only	Two-dimensional area calculated by projection onto a horizontal plane.
A 3D	Display only	Three-dimensional area calculated by projection onto an automatically defined horizontal reference plane. The 3D area is calculated based on the following: <ul style="list-style-type: none"> The system will use the three points which cover the largest area. If there are two or more equal largest areas, the system will use the area with the shortest perimeter. If the largest areas have equal perimeters, the system will use the area with the last measured point.
Per.	Display only	The perimeter of the area.
DTM-V	Display only	Volume as calculated by by Triangulated Irregular Network (TIN) .

Field	Option	Description
DTM-Grd.Area	Display only	Area defined by ground points, calculated by TIN.
BreakLn Area	Display only	Area defined by breakline points, calculated by TIN.
DTM-Volume I	Display only	Volume as calculated by TIN.
Swell Factor	Editable field	Factor that gives the relationship between the volume of a material as found in nature, to the volume of the same material after excavation. Refer to the table "Swell Factor" for more information on swell factors.
DTM-Volume II	Display only	Volume of the material after excavation from its original location. DTM-Volume II = DTM-Volume I x Swell Factor.
Weight Factor	Display only	Weight in tons per m ³ of material. Editable field.
Weight	Display only	Total weight of material after being excavated. Weight = DTM-Volume II x Weight Factor.

Swell Factor

According to DIN18300, the following soil classes have the given swell factors.

Soil class	Description	Swell Factor
1	Topsoil containing unorganic material, as well as humus or organic animals.	1.10 - 1.37
2	Fluent soil types of fluid to semi-fluid consistency.	n/a
3	Easily degradable soil types. Cohesionless to hardly cohesive sands.	1.06 - 1.32
4	Moderately degradable soil types. Mixture of sand, silt and clay.	1.05 - 1.45
5	Hard to degrade soil types. Same soil types as classes 3 and 4, but with a greater ratio of stones bigger than 63mm and between 0.01 m ³ to 0.1 m ³ in volume.	1.19 - 1.59
6	Rock types that have an inner mineral cohesiveness, however are fragmented, slaty, soft or weathered.	1.25 - 1.75
7	Hard to degrade rock types with a strong inner mineral cohesiveness and minimal fragmenting or weathering.	1.30 - 2.00

Swell factor examples: The values given are approximate only. Values may be different depending on various soil factors.

Soil type	Swell factor	Weight per cubic metre
Silt	1.15 - 1.25	2.1 t
Sand	1.20 - 1.40	1.5 - 1.8 t

Soil type	Swell factor	Weight per cubic metre
Clay	1.20 - 1.50	2.1 t
Topsoil, humus	1.25	1.5 - 1.7 t
Sandstone	1.35 - 1.60	2.6 t
Granite	1.35 - 1.60	2.8 t

7.9.5

Area Division

Area division methods

The diagrams show the area division methods.

Area Division method	Description
----------------------	-------------

Parallel line(%)

The border will be parallel to a line defined by two points. The division is calculated using a defined percentage split.

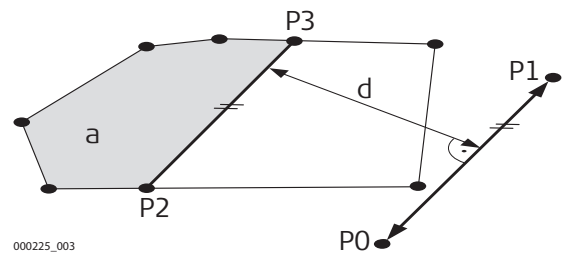

- P0 First point of defined line
- P1 Second of defined line
- P2 **Ptn1** First new point on parallel line
- P3 **Ptn2** Second new point on parallel line
- d Distance
- a **ALeft**

Perpend. line(%)

The border will be perpendicular to a line defined by two points. The division is calculated using a defined percentage split.

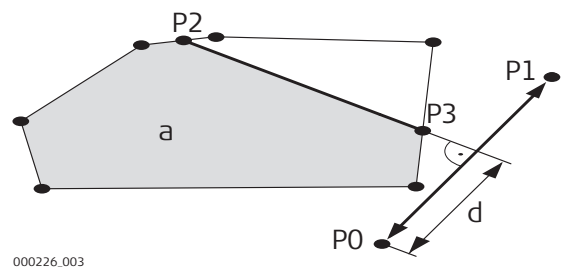

- P0 First point of defined line
- P1 Second of defined line
- P2 **Ptn1** First new point on perpendicular line
- P3 **Ptn2** Second new point on perpendicular line
- d Distance
- a **ALeft**

Area Division method	Description
Swing line(%)	The area is divided by a line rotated around an existing point of the area. The division is calculated using a defined percentage split.

007473.002

P0 Selected rotation point
 P1 New point on swing line
 α **Azim.**
 a **ALeft**

Area Division

1. Measure or select existing points to define the area.
2. The 2D area is calculated automatically and displayed once three points have been measured or selected.
 Only the 2D area is used for area division.

3. Press **Calc.**

4. **2D Area Results** screen:

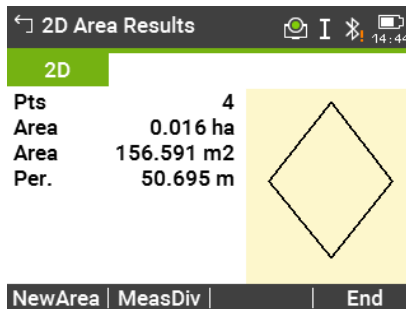

NewArea

To measure or define a new area.

MeasDiv

To define the area division according to the previous selected method.

End

To exit the app.

5. Press **MeasDiv.**

6. For **Parallel line(%)** and **Perpend. line(%)**:
Measure or select existing points to define the area division line.

For **Swing line(%)**:
Select an existing point of the area to define the rotation point of the swing line.

7. Press **Calc.**

8. For **Parallel line(%)** and **Perpend. line(%)**:
Enter the percentage of the area division **ALeft** for the new left area.

For **Swing line(%)**:
Enter the percentage of the area division **ALeft** for the new left area.

9. Press **Calc.**

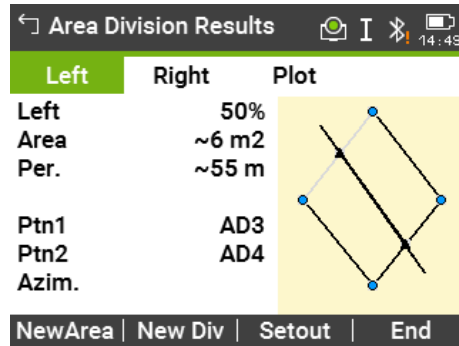

Key	Description
NewArea	To measure or define a new area.
New Div	To define a new area division.
Setout	To stake out the calculated points.
End	To store the intersection points as fixpoints and to exit the app.

Description of fields

Field	Option	Description
Left and Right	Display only	The size of the sub areas in percent.
Area	Display only	The size of the sub area in m ² .
Per.	Display only	The perimeter of the sub area in m.
Ptn1	Display only	The first intersection point of the new boarder with the original area.
Ptn2	Display only	The first intersection point of the new boarder with the original area.
Azim.	Display only	The angle of the new border from rotation point to the new point.

7.10

Remote Height

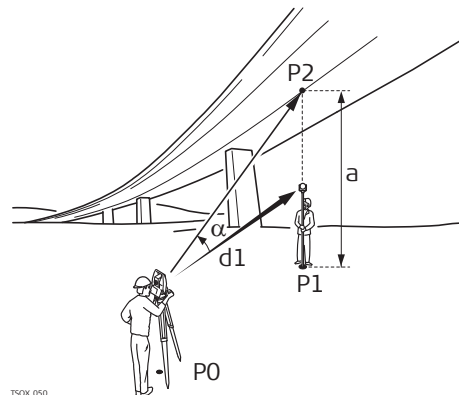

Description

Remote Height is an app used to compute points directly above the base prism without a prism at the target point.



- P0 Instrument station
- P1 Base point
- P2 Remote point
- d1 Slope distance
- a Height difference from P1 to P2
- α Vertical angle between base point and remote point

Access

1. Select **Apps** from the **Main Menu**.

2. Select **Remote Ht** from the **Programs Menu**.

3. Complete app pre-settings. Refer to "6 Apps - Getting Started".

Remote height measurement

Measure to the base point or press **hr=?** to determine an unknown target height.

Next step

After measuring, the **Aim at remote point!** screen appears.

Remote Height - Result - Aim at remote point!

Aim the instrument at the inaccessible remote point.

Description of fields

Field	Option	Description
Δ 	Display only	Height difference between the base point and the remote point.
Height	Display only	Height of the remote point.
East	Display only	Calculated Easting coordinate for the remote point.
North	Display only	Calculated Northing coordinate for the remote point.
Δ East	Display only	Calculated difference in Easting coordinate between the base point and the remote point.
Δ North	Display only	Calculated difference in Northing coordinate between the base point and the remote point.
Δ Height	Display only	Calculated difference in Height between the base point and the remote point.

Next step

- Either, press **Cont** to save the measurement and record the calculated coordinates of the remote point.
- Or, press **Base** to enter and measure a new base point.
- Or, press **ESC** to exit the app.

7.11

COGO

7.11.1



Starting

Description

COGO is an app used to perform **coordinate geometry** calculations such as, coordinates of points, bearings between points and distances between points. The COGO calculation methods are:

- Inverse and Traverse
- Intersections
- Offset
- Extension

Access

1. Select **Apps** from the **Main Menu**.

2. Select **COGO** from the **Programs Menu**.

3. Complete app pre-settings. Refer to "6 Apps - Getting Started".
4. Select a COGO subapp from the **COGO Main Menu**.

Graphics

In the Results screen, press **Setout** to access the Stakeout graphic.

Or, in the Results screen, change to the second page for a simple graphic. Refer to "3.8 Graphic Symbols" for a description of the graphic symbols.

7.11.2

Inverse and Traverse

Access

Select **Inverse** or **Traverse** from the **COGO Main Menu**.

Inverse

Use the **Inverse** subapp to calculate the distance, direction, height difference and grade between two known points.

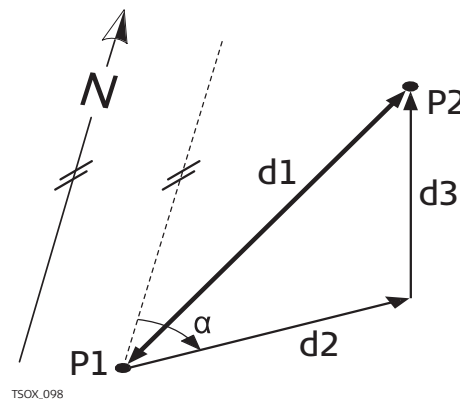

Known

- P1 First known point
- P2 Second known point

Unknown

- α Direction from P1 to P2
- d1 Slope distance between P1 and P2
- d2 Horizontal distance between P1 and P2
- d3 Height difference between P1 and P2

Traverse

Use the **Traverse** subapp to calculate the position of a new point using the bearing and the distance from a known point. Offset optional.

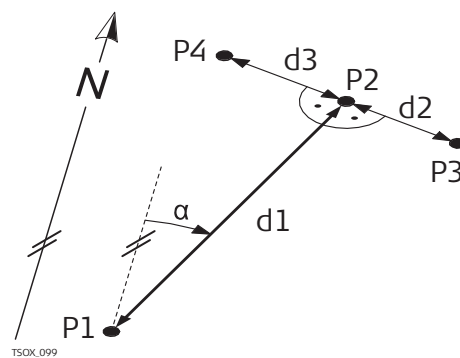

Known

- P1 Known point
- α Direction from P1 to P2
- d1 Distance between P1 and P2
- d2 Positive offset to the right
- d3 Negative offset to the left

Unknown

- P2 COGO point without offset
- P3 COGO point with positive offset
- P4 COGO point with negative offset

7.11.3

Intersections

Access

Select the desired COGO subapplication from the **COGO Main Menu**:

- **Brg-Brg**
- **Brg-Dst**
- **Dst-Dst**
- **4 Point**

Bearing - Bearing

Use the **Bearing - Bearing** subapp to calculate the intersection point of two lines. A line is defined by a point and a direction.

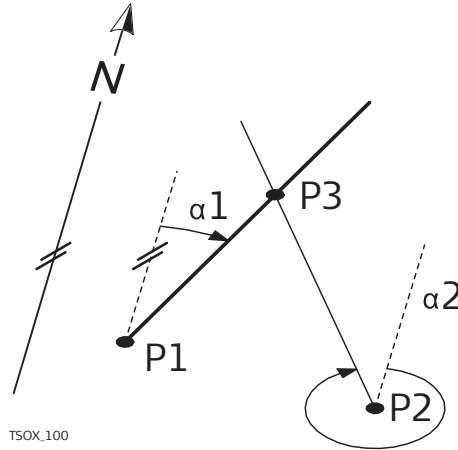

Known

- P1 First known point
- P2 Second known point
- $\alpha 1$ Direction from P1 to P3
- $\alpha 2$ Direction from P2 to P3

Unknown

- P3 COGO point

Bearing - Distance

Use the **Bearing - Distance** subapp to calculate the intersection point of a line and a circle. The line is defined by a point and a direction. The circle is defined by the center point and the radius.

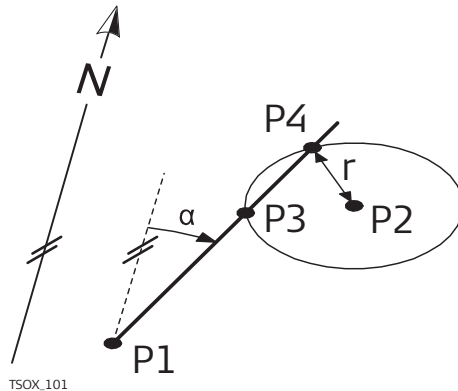

Known

- P1 First known point
- P2 Second known point
- α Direction from P1 to P3 and P4
- r Radius, as the distance from P2 to P4 or P3

Unknown

- P3 First COGO point
- P4 Second COGO point

Distance - Distance

Use the **Distance - Distance** subapp to calculate the intersection point of two circles. The circles are defined by the known point as the center point and the distance from the known point to the COGO point as the radius.

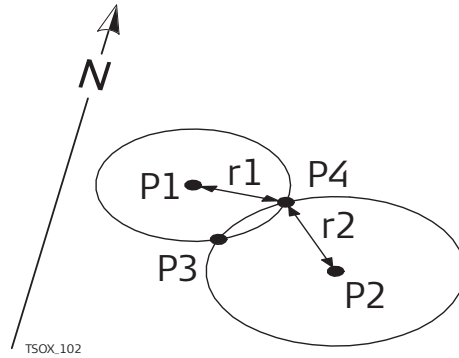

Known

- P1 First known point
- P2 Second known point
- r1 Radius, as the distance from P1 to P3 or P4
- r2 Radius, as the distance from P2 to P3 or P4

Unknown

- P3 First COGO point
- P4 Second COGO point

4 Point

Use the **4 Point** subapp to calculate the intersection point of two lines. A line is defined by two points.

To add a shift for the lines, change to page **2/2** for TS03 or page **Shifts** for TS07. + indicates a shift to the right. - indicates a shift to the left.

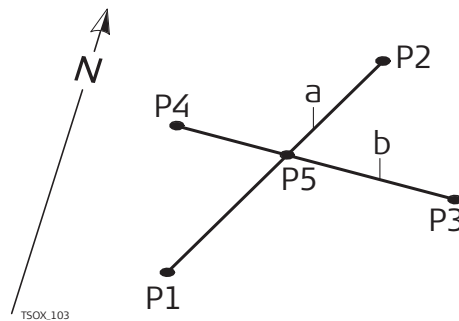

Known

- P1 First known point
- P2 Second known point
- P3 Third known point
- P4 Fourth known point
- a Line from P1 to P2
- b Line from P3 to P4

Unknown

- P5 COGO point

7.11.4

Offsets

Access

Select the desired COGO subapplication from the **COGO Main Menu**:

- **DistOff**
- **Set Pt**
- **Plane**

Distance Offset

Use the **Distance Offset** subapp to calculate the distance and offset of a known point, with the basepoint in relation to a line.

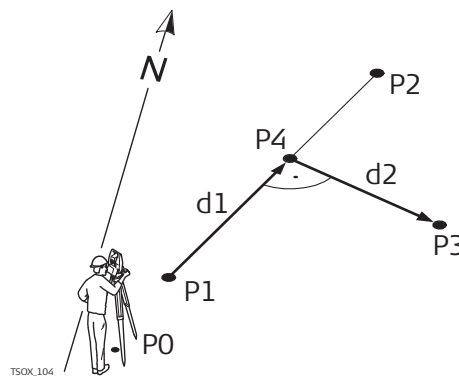

Known

- P0 Instrument station
- P1 Start point
- P2 End point
- P3 Offset point

Unknown

- d1 Δ Line
- d2 Δ Offset
- P4 COGO (base) point

Set Point by Distance Offset

Use the **Set Point by Distance Offset** subapp to calculate the coordinates of a new point in relation to a line from known longitudinal and offset distances.

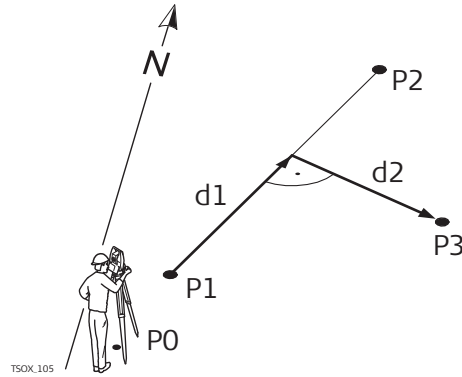

Known

- P0 Instrument station
- P1 Start point
- P2 End point
- d1 Δ Line
- d2 Δ Offset

Unknown

- P3 COGO point

Plane Offset

Use the **Plane Offset** subapp to calculate the coordinates of a new point and its height and offset, in relation to a known plane and offset point.

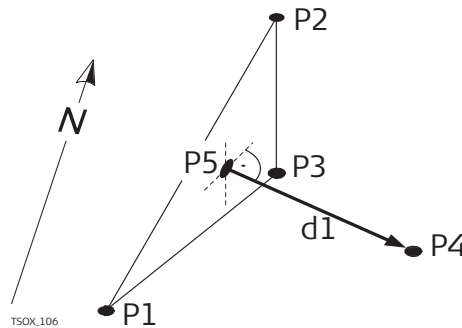

Known

- P1 Point 1 which defines plane
- P2 Point 2 which defines plane
- P3 Point 3 which defines plane
- P4 Offset point

Unknown

- P5 COGO (intersection) point
- d1 Offset

7.11.5

Line - Extension

Access

Select **Extens.** from the **COGO Main Menu**.

Line - Extension

Use the **Line - Extension** subapp to calculate the extended point from a known base line.

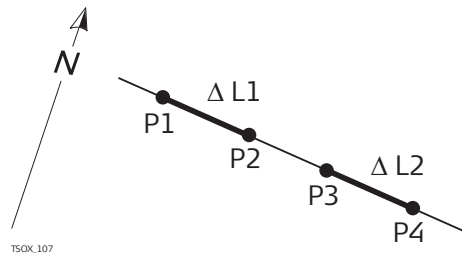

Known

- P1 Baseline start point
- P3 Baseline end point
- $\Delta L1, \Delta L2$ Distance

Unknown

- P2, P4 Extended COGO points

7.12

Road 2D

Description

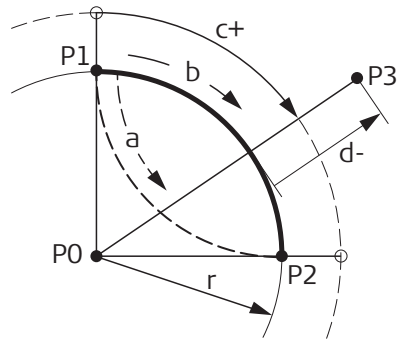

Road 2D is an app used to measure or stake out points relative to a defined element. The element can be a line, curve or spiral. Chainage, incremental stake outs and offsets (left and right) are supported.



- P0 Center point
- P1 Start point of arc
- P2 End point of arc
- P3 Point to stake
- a Anti-clockwise
- b Clockwise
- c+ Distance from start of arc, following curve
- d- Perpendicular offset from arc
- r Radius of arc

TSOX.132

Access

1. Select **Apps** from the **Main Menu**.

2. Select **Road 2D** from the **Programs Menu**.

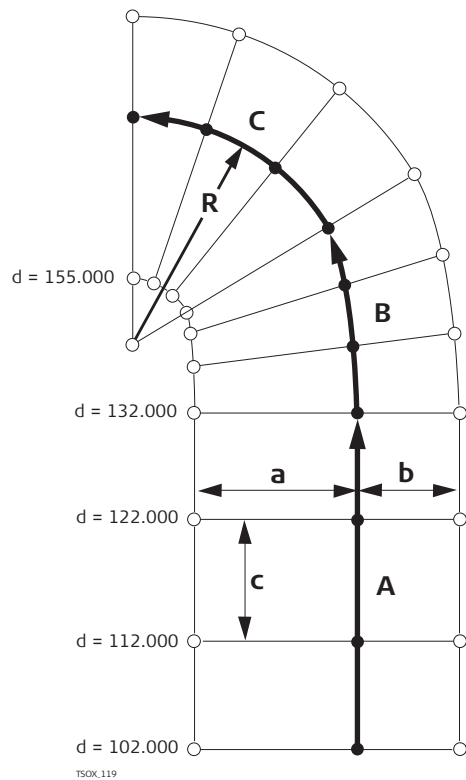
3. Complete app pre-settings. Refer to "6 Apps - Getting Started".
4. Select the element type:
 - **Straight**
 - **Curve**
 - **Spiral**

Elements



- A Straight
- B Spiral
- C Curve
- R Radius
- a Perpendicular offset left
- b Perpendicular offset right
- c Increment
- d Chainage

TSOX.119

Define the element step-by-step

1. Enter, measure or select from memory the start and end points.
2. For curve and spiral elements the **Road 2D** screen for defining the element appears.

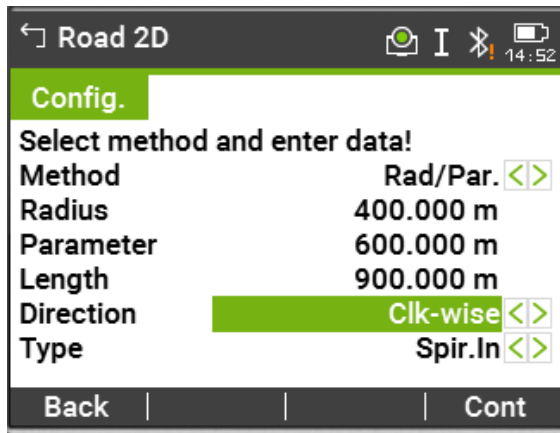

3. For a curve element:
 - Enter the radius and curve direction.
 - Press **Cont**.
- For a spiral element:
 - Select the method to be used, **Rad/Par.** or **Rad/Len..**
 - Enter the radius and parameter, or radius and length, depending on the method chosen.
 - Select the type and direction of the spiral.
 - Press **Cont**.

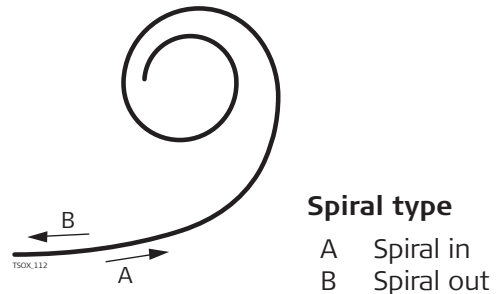

4. When the element has been defined the **Road 2D - Config.** appears.

Chainage and method

Enter the chainage values and press:

- **Setout:** to select the point and offset (center, left or right), to stake out and start the measurement. The correction from actual point to stake out point is shown on the display.
- **Check:** to measure, or select points from memory, to calculate the chainage, line and offset from the defined element.

Enter stakeout values

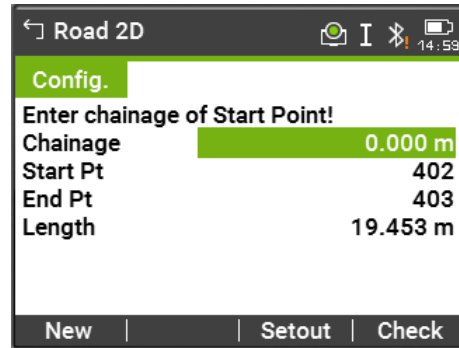

Next step

- If in stakeout mode, press **Cont** to begin staking out.
- Or, if in measurement mode, press **Meas** to measure and record.

7.13

Road 3D

7.13.1

Starting

Description

Road 3D is an app used to stake out points or for as-built checks relative to a road alignment, including slopes. It supports the following features:

- Horizontal alignments with the elements straight, curve, and spiral (entry and exit as well as partial).
- Vertical alignments with the elements straight, curve and quadratic parabola.
- Upload of horizontal and vertical alignments which are in gsi data format of Leica Infinity Road Line Editor.
- Creation, view and deletion of alignments onboard.
- Use of design height of vertical alignments or manually entered heights.
- Log file via Format manager of Leica Infinity.

Road 3D methods

Road 3D has the following subapps:

- Subapp Check
- Subapp Stake
- Subapp Check Slope
- Subapp Stake Slope



The app can be trialled 15 times. After 15 trials, it is necessary to enter the licence code.

Road 3D step-by-step

1. Create or upload road alignments.
2. Select horizontal and/or vertical alignment files.
3. Define stake/check/slope parameter.
4. Select one of the Road 3D subapps.



- The alignment file data has to be in the same data structure as Leica Infinity Road Line Editor. These gsi files have unique identifiers for each element which are used by the app.
- The alignments must be continuous because geometrical gaps and chain-age equations are not supported.
- The file name for the horizontal alignment file must have the prefix ALN, for example, ALN_HZ_Axis_01.gsi. The file name for the vertical alignment files must have the prefix PRF, for example PRF_VT_Axis_01.gsi. File names can be 16 characters long.
- The uploaded or created road alignments are permanent and stored even if the app is closed.
- Road alignments can be deleted onboard or via Leica Infinity Data Exchange Manager.
- Road alignments cannot be edited onboard. This needs to be done via Leica Infinity Road Line Editor.

7.13.2

Basic Terms

Elements of a road project

Road projects consist, in general, of a horizontal and a vertical alignment. Any project point P1 has E, N and H coordinates in a determined coordinate system and has three positions.

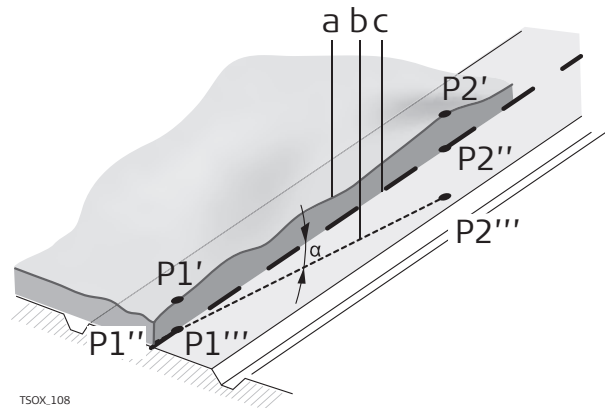

- P1' Position on natural surface
- P1'' Position on vertical alignment
- P1''' Position on horizontal alignment

With a second point P2 the alignment is defined.

- P1' P2' Projection of the alignment onto the natural surface.
- P1'' P2'' Vertical alignment
- P1''' P2''' Horizontal alignment
- α Grade angle between the vertical and horizontal alignment.
- a Natural surface
- b Horizontal alignment
- c Vertical alignment

Horizontal geometry elements

For onboard input Road 3D supports the following elements for horizontal alignments.

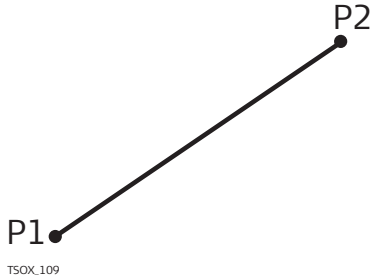
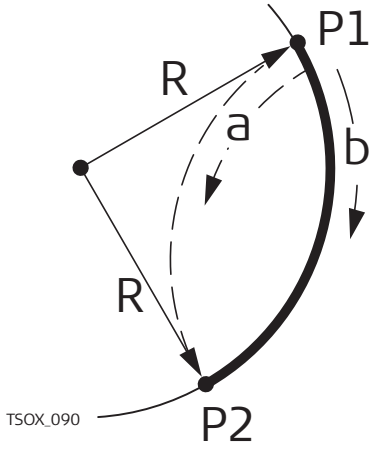
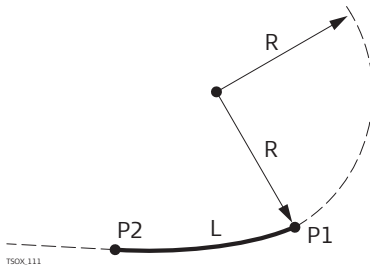
Element	Description
Straight	<p>A straight has to be defined by:</p> <ul style="list-style-type: none"> Start point (P1) and end point (P2) with known Easting and Northing coordinates.
	 <p style="text-align: right;">P1 Start point P2 End point</p>
Curve	<p>A circular curve has to be defined by:</p> <ul style="list-style-type: none"> Start point (P1) and end point (P2) with known Easting and Northing coordinates. Radius (R). Direction: Clockwise (b) or Anticlockwise (a).
	 <p style="text-align: right;">P1 Start point P2 End point R Radius a Anticlockwise direction b Clockwise direction</p>
Spiral / Clothoid	<p>A spiral is a transition curve whose radius changes along its length. A spiral has to be defined by:</p> <ul style="list-style-type: none"> Start point (P1) and end point (P2) with known Easting and Northing coordinates. Radius at the start of the spiral (R). Spiral parameter (A) or length (L) of the spiral. $A = \sqrt{L \cdot R}$ Direction: Clockwise or Anticlockwise. Spiral type: Spiral in or Spiral out.
	 <p style="text-align: right;">P1 Start point P2 End point R Radius L Length</p>

Element	Description
Spiral types	<ul style="list-style-type: none"> • Entry spiral (Spiral in = A): Spiral with a radius of infinity at the start and a given radius at the end. • Exit spiral (Spiral out = B): Spiral with a given radius at the start and radius of infinity at the end. • Partial/Ovoid spiral: A spiral with a given radius at the start and another given radius at the end.

A Entry spiral
B Exit spiral

Vertical geometry elements

For onboard input Road 3D supports the following elements for vertical alignments.

Element	Description
Straight	<p>A straight has to be defined by:</p> <ul style="list-style-type: none"> • Start chainage and start height of P1. • End chainage and end height of P2, or length (L) and slope (%).
	<div style="display: flex; align-items: center;"> <div style="text-align: center; margin-right: 20px;"> <p>TS0K.113</p> </div> <div style="text-align: center; margin-right: 20px;"> <p>TS0K.112</p> </div> <div style="margin-left: 20px;"> <p>P1 Start point P2 End point L Length % Slope</p> </div> </div>
Transition curve	<p>A circular curve has to be defined by:</p> <ul style="list-style-type: none"> • Start chainage and start height of P1. • End chainage and end height of P2. • Radius (R). • Type: Convex (crest) or Concave (sag).
	<div style="display: flex; align-items: center;"> <div style="text-align: center; margin-right: 20px;"> <p>TS0K.051</p> </div> <div style="text-align: center; margin-right: 20px;"> <p>TS0K.051</p> </div> <div style="margin-left: 20px;"> <p>a Convex b Concave P1 Start point P2 End point R Radius</p> </div> </div>
Quadratic parabola	<p>A quadratic parabola has the advantage that the rate of change of grade is constant, resulting in a "smoother" curve. A quadratic parabola has to be defined by:</p> <ul style="list-style-type: none"> • Start chainage and start height of P1. • End chainage and end height of P2. • Parameter, or Length (L), grade of entry straight (GradeIn) and grade of exit straight (GradeOut).

Element	Description
	P1 Start point P2 End point L Length % Slope

Horizontal and vertical geometry elements combined

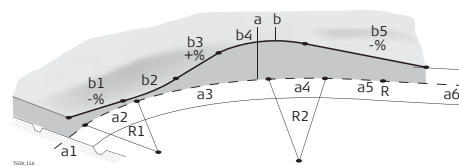

- a = Horizontal alignment (top view)
- R1 Radius 1
- R2 Radius 2
- a1 Straight
- a2 Curve with R1
- a3 Partial spiral with R1 and R2
- a4 Curve with R2
- a5 Spiral out with R2 and $R=\infty$
- a6 Straight
- b = Vertical alignment (front view)
- b1 Straight
- b2 Curve
- b3 Straight
- b4 Parabola
- b5 Straight
- Tangent point



Start and end chainage and tangent points can be different for the horizontal and vertical alignments.

Slope elements

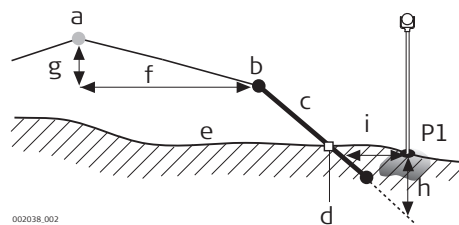

- P1 Measured point
- a Horizontal alignment
- b Hinge point
- c Slope
- d Catch point
- e Natural surface
- f Defined offset
- g Defined height difference
- h Cut situation for defined slope
- i Δ Offset to catch point

Explanation of the slope elements:

- a **Horizontal alignment** at a defined chainage.
- b **Hinge point**, is defined by entered offset left/right and height difference.
- c **Slope** = ratio.
- d **Catch point**, or daylight point, indicates the point of intersection between the slope and the natural surface. Both the hinge point and the catch point lie on the slope.
- e **Natural surface**, is the undisturbed surface before project construction.

Cut / Fill	Description
------------	-------------

Cut situation

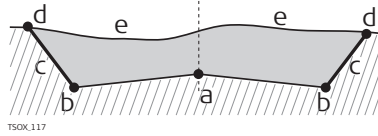

- a Horizontal alignment
- b Hinge point
- c Slope
- d Catch point
- e Natural surface

Fill situation

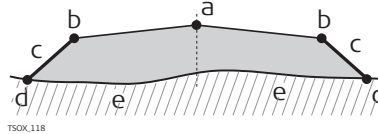

- a Horizontal alignment
- b Hinge point
- c Slope
- d Catch point
- e Natural surface

7.13.3



Creating or Uploading Alignment Files

Description

Create horizontal and vertical road alignment files with Instrument Tools Road Line Editor and upload them onto the instrument using the Data Exchange Manager.

Alternatively, horizontal and vertical road alignments can be created onboard the instrument.



Access

1. Select **Apps** from the **Main Menu**.

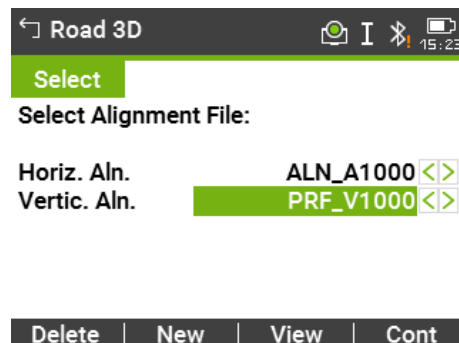
2. Select **Road 3D** from the **Programs Menu**.

3. Complete app pre-settings. Refer to "6 Apps - Getting Started".

Select Alignment File:



Description of fields

Field	Description
Horiz. Aln.	List of available horizontal alignment files.  Using a horizontal alignment file is mandatory.
Vertic. Aln.	List of available vertical alignment files.  Using a vertical alignment file is not mandatory. A height can be defined manually instead.

Next step

- Either, press **New** to name and define a new alignment file.
- Or, press **Cont** to select an existing alignment file and proceed to the **Setout/Check/Slope** values screen.

Setout/Check/Slope

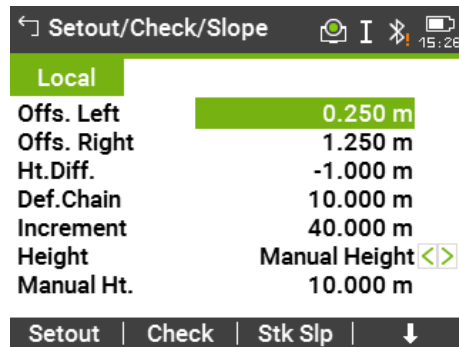

Key	Description
Setout	To start the subapp Stake .
Check	To start the subapp Check .
Stk Slp	To start the subapp Stake Slope .
↓ Ch Slp	To start the subapp Check Slope .

Description of fields

Field	Option	Description
Offs. Left	Editable field	Horizontal offset to the left of the horizontal alignment.
Offs. Right	Editable field	Horizontal offset to the right of the horizontal alignment.
Ht. Diff.	Editable field	Vertical offset, either up or down, from the horizontal alignment.
Def. Chain	Editable field	Defined chainage for stake out.
Increment	Editable field	Value by which the defined chainage can be incremented or decremented in subapps Stake and Stake Slope.
Height	Manual Height	Height reference for height calculations. If enabled this height is used for all subapps.

Field	Option	Description
	Use Design Hgt.	The height reference for height calculations is the selected vertical alignment file.
Manual Ht.	Editable field	Height to be used for Manual Height .

Next step

Select a softkey option, **Setout**, **Check**, **Stk Slp** or **↓Ch Slp**, to proceed to a subapp.

7.13.4

Stake

Description

The subapp Stake is used to stake out points relative to an existing alignment. The height difference is relative to a vertical alignment or manually entered height.

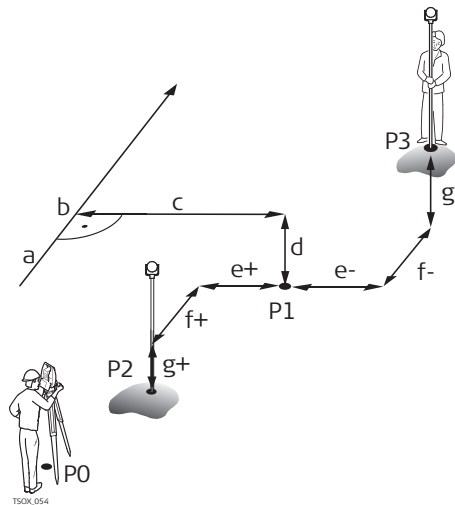

- P0 Instrument station
- P1 Target point
- P2 Measured point
- P3 Measured point
- a Horizontal alignment
- b Defined chainage
- c Offset
- d Height difference
- e+ Δ Offset, positive
- e- Δ Offset, negative
- f+ Δ Chainage, positive
- f- Δ Chainage, negative
- g+ Δ Height, positive
- g- Δ Height, negative

Access

Press **Setout** from the **Setout/Check/Slope** values screen.

Setout

 To find/enter codes, press the Favourites key and select **Coding**.

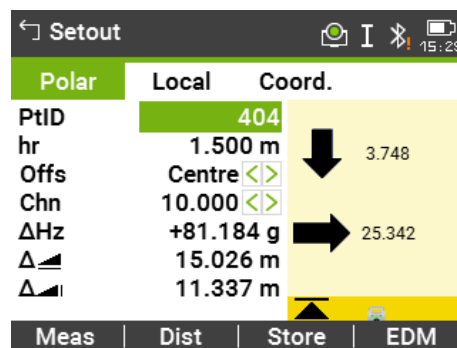

Description of fields

Field	Option	Description
DefChain	Selectable list	Selected chainage to stake out.
ΔHz	Display only	Angle offset: Positive if the stake out point is to the right of the measured point.

Field	Option	Description
Δ	Display only	Horizontal offset: Positive if the stake out point is further away than the measured point.
Δ Height	Display only	Height offset: Positive if the stake out point is higher than the measured point.
Δ Chain	Display only	Longitudinal offset: Positive if the stake out point is further away than the measured point.
Δ Offset	Display only	Perpendicular offset: Positive if the stake out point is to the right of the measured point.
Def. East	Display only	Calculated East coordinate of the stake out point.
Def. North	Display only	Calculated North coordinate of the stake out point.
Def. Height	Display only	Calculated Height of the stake out point.

Next step

- Either, press **Meas** to measure and record.
- Or, press **ESC** to return to the **Setout/Check/Slope** values screen.

7.13.5

Check

Description

The subapp Check is used for as-built checks. The points can be measured or selected from the memory. The chainage and offset values are relative to an existing horizontal alignment, and the height difference is relative to a vertical alignment or manually entered height.

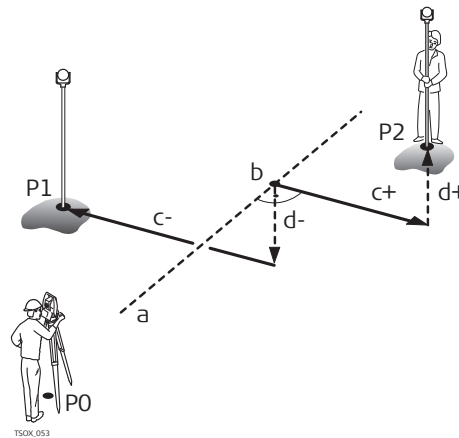

- P0 Instrument station
- P1 Target point
- P2 Target point
- a Horizontal alignment
- b Chainage
- c+ Offset, positive
- c- Offset, negative
- d+ Height difference, positive
- d- Height difference, negative



Defined chainage and increment values will not be considered in the subapp Check.

Access

Press **Check** from the **Setout/Check/Slope** values screen.

3D-Road Check	
Local	Coord.
PtID	403
hr	1.500 m
Offset	Centre <>
Chainage	19.453 m
Offset	-0.000 m
Ht.Diff.	-0.768 m
Height	8.232 m

Find | List | Map | ↓

Description of fields

Field	Option	Description
Offset	Left, Right or Centre.	Defined horizontal offset.
Chainage	Display only	Current chainage from measured point.
Offset	Display only	Perpendicular offset to alignment.
Ht.Diff.	Display only	Height difference between the measured point and the defined height.
ΔEast	Display only	Calculated difference in Easting coordinate between the measured point and the alignment element.
ΔNorth	Display only	Calculated difference in Northing coordinate between the measured point and the alignment element.

Next step

- Either, press **Meas** to measure and record.
- Or, press **ESC** to return to the **Setout/Check/Slope** values screen.

7.13.6

Stake Slope

Description

The subapp Stake Slope is used to stake out the catch point, which is the intersection point of a defined slope with the natural surface.

The slope is always defined as starting from a hinge point. If the parameter offset right/left and height difference are not entered, the point at the defined chainage on the horizontal alignment is the hinge point.

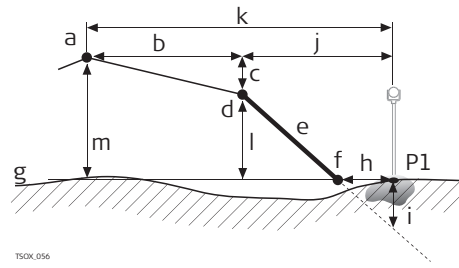

- P1 Measured point
- a Horizontal alignment
- b Defined offset
- c Defined height difference
- d Hinge point
- e Defined slope
- f Catch point
- g Natural surface
- h Δ Offset to catch point
- i Cut/fill to catch point
- j Offset to hinge point
- k Offset to alignment
- l Height difference to hinge point
- m Height difference to alignment

Access

Press **Stk Slp** from the **Setout/Check/Slope** values screen.

Define Slope Setout

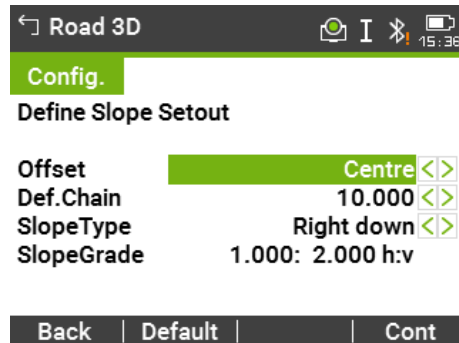

Description of fields

Field	Option	Description
Offset	Selectable list	Horizontal offset from the horizontal alignment to define the hinge point.
Def.Chain	Selectable list	Defined chainage for stakeout.
SlopeType	Selectable list	Type of slope.

Left up Hinge point **Right up**

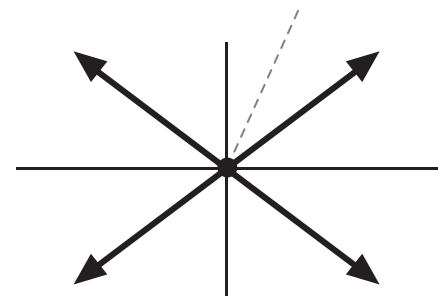

Left down **Right down**

Creates an upward plane extending to the left of the defined hinge point.

Field	Option	Description
	Right up	Creates an upward plane extending to the right of the defined hinge point.
	Left down	Creates a downward plane extending to the left of the defined hinge point.
	Right down	Creates a downward plane extending to the right of the defined hinge point.
SlopeGrade	Display only	Ratio of the slope. The unit for slope grade is defined in the Regional Settings screen. Refer to "5.2 Regional Settings".

Slope Setout

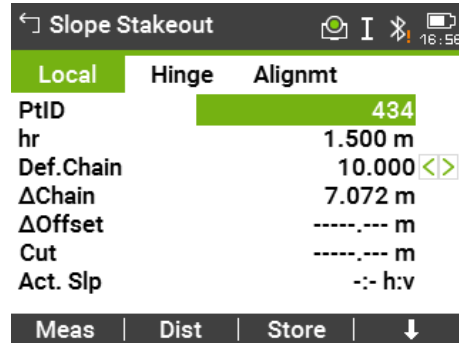

Description of fields

Field	Option	Description
DefChain	Editable field	Defined chainage for stake out.
ΔChain	Selectable list	Difference between the defined chainage and the measured chainage.
ΔOffset	Display only	Horizontal offset between the catch point of defined slope and the measured position.
Cut/Fill	Display only	Vertical offset between the catch point of the defined slope and the measured position. A cut is above the slope, a fill is below the slope.
Act.Slope	Display only	Measured slope of the reflector position to the hinge point.
Offs.Hng	Display only	Measured offset to the horizontal alignment including offset right and offset left.
ΔH Hinge	Display only	Height difference to the hinge point. The vertical offset between the defined height at the current chainage, and the measured position, including the defined height difference.
▲ Hinge	Display only	Slope distance from the measured point to the hinge point.
Height	Display only	Height value of the measured point.
Act. Ch.	Display only	The measured chainage.
Offs.Aln	Display only	Measured offset to the horizontal alignment excluding offset right and offset left.

Field	Option	Description
ΔH Aln	Display only	Height difference to the alignment. The vertical offset between defined height at the current chainage, and the measured position, excluding the defined height difference.
∇ Aln	Display only	Slope distance from the measured point to the alignment.

Sign convention

Cut situation

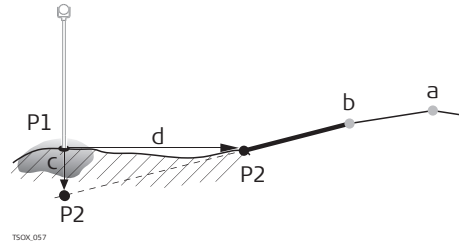

- P1 Measured point
- P2 Catch point
- a Horizontal alignment
- b Hinge point
- c Cut
- d Δ Offset to catch point

Fill situation

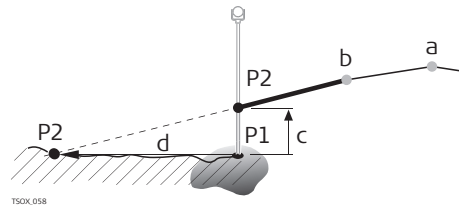

- P1 Measured point
- P2 Catch point
- a Horizontal alignment
- b Hinge point
- c Fill
- d Δ Offset to catch point

Next step

- Either, press **Meas** to measure and record.
- Or, press **ESC** to return to the **Setout/Check/Slope** values screen.

7.13.7

Check Slope

Description

The subapp Check Slope is used for as-built checks and to get information about slopes, for example on a natural surface. If the parameter offset left/right and height difference are not entered, the point on the horizontal alignment is the hinge point.

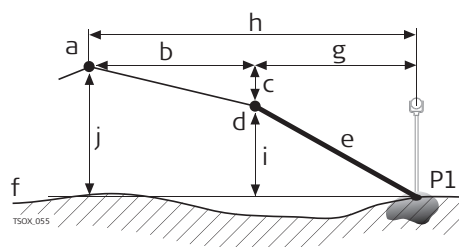

- P1 Measured point
- a Horizontal alignment
- b Defined offset
- c Defined height difference
- d Hinge point
- e Actual slope
- f Natural surface
- g Offset to hinge point
- h Offset to alignment
- i Height difference to hinge point
- j Height difference to alignment



Defined chainage and increment values will not be considered.

Slope Check Hinge Val.

Slope	Height	Alignmt
PtID		434
hr		1.500 m
Offset		Left <>
Chainage		2.928 m
Offs.Hng		0.983 m
ΔH Hinge		----- m
Act. Slp		-:- h:v

Meas | Dist | Store | ↓

Description of fields

Field	Option	Description
Offset	Selectable list	Defined horizontal offset. Left, Right or Center.
Chainage	Display only	Current chainage from measured point.
Offs.Hng	Display only	Offset to hinge. Measured offset to the horizontal alignment including offset right and offset left.
ΔH Hinge	Display only	Height difference to the hinge point. The vertical offset between the defined height at the current chainage, and the measured position including defined height difference.
Act. Slp	Display only	The measured slope ratio of the measured point to the hinge point.
↙Hinge	Display only	Slope distance from the measured point to the hinge point.
Height	Display only	Height value of the measured point.
Offs.Aln	Display only	Measured offset to the horizontal alignment excluding offset right and offset left.
ΔH Aln	Display only	Height difference to the alignment. The vertical offset between defined height at the current chainage, and the measured position, excluding the defined height difference.
↙Aln	Display only	Slope distance from the measured point to the alignment.

Next step

- Either, press **Meas** to measure and record.
- Or, press **ESC** to return to the **Setout/Check/Slope** values screen.
- Or, continue selecting **ESC** to exit the application.

7.14

Traverse

7.14.1

Overview





Traverse can be trialled 15 times. After 15 trials, it is necessary to enter a licence code.

Description	<p>Traverse is an app used to establish control networks whereby other survey operations such as topographic surveys or point stake outs can be completed. The Traverse methods include 2D Helmert transformation, compass rule and transit rule.</p>
2D Helmert transformation	<p>A Helmert transformation is calculated based on two control points. These must be the start point and the end, or closing, station. Shift, rotation and scale factor will be computed and applied to the traverse.</p> <p>Starting a traverse without an initial backsight measurement will automatically result in a Helmert transformation.</p>
Compass rule	<p>The coordinate misclosure will be distributed with respect to the length of the traverse legs. The compass rule assumes that the biggest error comes from the longest traverse observations. This method is suitable when the precision of the angles and distances are approximately equal.</p>
Transit rule	<p>The coordinate misclosure will be distributed with respect to the coordinate changes in Easting and Northing. Use this method if the angles were measured with a higher precision than the distances.</p>
Traverse step-by-step	<ol style="list-style-type: none"> 1. Start and configure Traverse. 2. Enter station data. 3. Select starting method. 4. Measure a backsight point or go directly to step 5.. 5. Measure a foresight point. 6. Repeat for the number of sets. 7. Move to the next station.
Traverse options	<ul style="list-style-type: none"> • It is also possible to observe sideshots and check points during the traverse, however, check points are not included in the traverse adjustment. • At the end of the traverse, results are displayed and an adjustment may be calculated if desired.

7.14.2

Starting and Configuring Traverse

Access	<ol style="list-style-type: none"> 1. Select Apps from the Main Menu.  2. Select Traverse from the Programs Menu.  3. Complete app pre-settings.
---------------	---

- **F1 Set Job:**
Only one traverse per job is allowed. If an adjusted or finished traverse is already part of the selected job, then select another job. Refer to "6 Apps - Getting Started".
- **F2 Set Tolerances:**
Use Tolerances: Yes to activate the use of tolerances. Enter limits for horizontal direction (the difference between measured and calculated azimuth to the closing point), distance (the distance between known and measured closing point), and for differences in Easting, Northing and Height. If the adjustment results, or the deviation for a check point, exceed these limits a warning message appears.
Press **Cont** to save the limits and return to the **Pre-settings** screen.

4. Select **F4 Start** to begin the app.



It is not recommended to start a traverse if the memory is almost full. Doing so, may mean the traverse measurements and results cannot be saved. Accordingly, a message is displayed if less than 10% of the memory is free.

Traverse configuration

Description of fields

Field	Option	Description
Traverse ID	Editable field	Name of the new traverse.
Desc.	Editable field	Description, if desired.
Operator	Editable field	Name of the user who will be using the new traverse, if desired.
Method	B'F'F"B"	All points are measured in face I, then all points are measured in face II in reverse sequential order.
	B'B"F"F'	The backsight point is measured in face I immediately followed by face II. Other points are measured in alternating face order.
	B'F'	All points are measured in face I only.
No. of Sets	Selectable list	Number of sets. Limited to 10.
Use Face-Tol.	Selectable list	Important when measuring with face I and II. This checks if both measurements are within a defined limit. If the limit is exceeded, a warning message is displayed.
Face-Tol.	Editable field	The limit that will be used for checking the face tolerance.

Next step

Press **Cont** to confirm the traverse configuration and proceed to the **Enter Station Data** screen.

Measure Traverse - Enter Station Data

Description of fields

Field	Option	Description
Stat.ID	Editable field	Name of the station.
hi	Editable field	Height of the instrument.
Desc.	Editable field	Description of the station, if desired.



Every Traverse must start on a known point.

Next step

Press **Cont** to confirm station data and proceed to the **Traverse - Select** screen.

7.14.3

Measuring Traverse

Access

From the **Traverse - Select** screen select one of the following:

- **F1 ...w/o known Backsight:** Starts the traverse without a known backsight. The measurements begin to a foresight point.
- **F2 ...with known Backsight:** Starts the traverse with a known backsight.
- **F3 ...with known Azimuth:** Starts the traverse with a user-defined azimuth.

Without known backsight

Start a traverse without a known backsight

- Start on a known point without an initial measurement to a known backsight.
- Stop on a known point, or make a final foresight measurement to a known closing point.

If the coordinates of the start station are unknown, the Station Setup app can be run before the traverse. A Helmert transformation will be performed at the end of the traverse.

If the traverse is left open, then the calculations are based on the system azimuth.

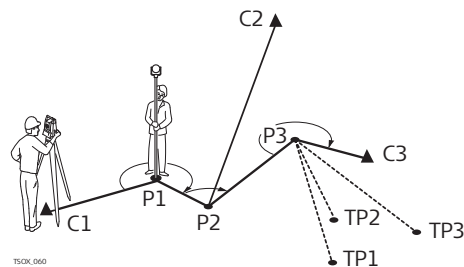

C1, C3 Control points
 C2 Check point
 P1-P3 Traverse points
 TP1-TP3 Topographic points

With known backsight

Start a traverse with a known backsight

- Start on a known point with an initial measurement to a known backsight.
- Stop on a known point and optionally measure to a known closing point.

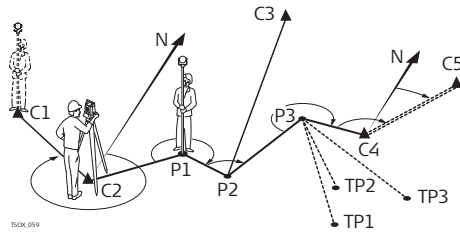

- C1, C2 Control points
- C4, C5 Control points
- C3 Check point
- P1...P3 Traverse points
- TP1...TP3 Topographic points
- N North direction

With known azimuth

Start a traverse with a known azimuth

- Start on a known point, aim to any direction (e.g. a tower) and define this direction as the reference. This method is often used to define a 0-direction.
- Stop/end the traverse either on a known point or a traverse point and then measure to a known closing point, or leave the traverse open. Refer to "7.14.5 Closing a Traverse".

If using the current system azimuth, for example from **Setup**, then simply confirm the suggested Hz-value in the **Set Horizontal Angle** screen.

Measure traverse - Sight Backsight!

Description of fields

Field	Option	Description
BS ID	Editable field	Point ID of the backsight point.
Remark	Editable field	Description of the backsight point.
Stat.ID	Editable field	Name of the station.

Next step

Depending on the traverse method configured, after the measurement either the **Sight Backsight!** screen stays active for measuring the backsight point in a second face, or the **Sight Foresight** screen appears for measuring the foresight point.

Measure traverse - Sight Foresight

Next step

Depending on the traverse method configured, after the measurement either the **Sight Foresight** screen stays active for measuring the foresight point in a second face, or the **Sight Backsight!** screen appears for measuring the backsight point.

Interrupt a set

To interrupt a set, press **ESC** to exit the backsight or foresight screen. The **Continue with...** screen will appear.

Continue with...

Field	Description
F1 Redo last measurement	Returns to last measured point, can be either a backsight or a foresight point. The last measurement is not stored.
F2 Redo whole station	Returns to first sight point screen. The data from the last station is not stored.

Field	Description
F3 Exit Traverse	Returns to the Apps Menu . The traverse stays active and can be continued later. The data from the last station is lost.
F4 Back	Returns to the previous screen where ESC was pressed.

Repetitive loop for the number of sets

Alternating between screens for the backsight and foresight measurements continues according to the configured number of sets.

The number of sets and the face are indicated in the top right corner of the screen. For example 1/I means set 1 in face I.

7.14.4

Moving ahead

Number of defined sets is achieved

When the number of defined sets is achieved, the **Traverse - Select** screen is displayed automatically. The accuracy of the set measurements is checked. The set can be accepted or redone.

Moving ahead with the traverse

From the **Traverse - Select** screen, select an option to move ahead with the traverse, or press **ESC** to redo the last station.

Field	Description
F1 Survey Sideshot	Enables the measurement of standard survey and topographic points. Measured points are stored with a Traverse flag. If the traverse is finally adjusted, these points will be updated. Close To exit the screen and returns to the Traverse - Select screen.
F2 Move to next Station	Move to the next station. The instrument can either be left on or turned off. If the instrument is turned off and then turned on again later, the message Last traverse not yet finished or processed! Do you really want to start a new traverse ? All existing data will be overwritten! will display. Selecting Yes will re-open the Traverse to continue at the new station. The start screen for the next station is similar to the Enter Station Data screen. The point ID of the foresight point of the last station is suggested as station ID automatically. Run through the loop of backsight and foresight measurements until the number of sets is reached.
F3 Measure Checkpoint	By measuring a check point it is possible to check whether the Traverse is still within certain deviations. A check point is excluded from the traverse calculation and adjustment, however, all measurement data and results observed from a check point are stored.

Field	Description
	<ol style="list-style-type: none"> 1. Enter the name of the check point and the height of the reflector. 2. Press Cont to go to the next screen. 3. Measure the check point. The differences in Easting, Northing and Height are displayed. <p>A message will appear if the tolerances defined in the Traverse configuration are exceeded.</p>

Next step

Close the traverse by selecting **Close** in the **Sight Foresight** screen after a backsight point measurement, but before the foresight point measurement.

7.14.5

Closing a Traverse

Access

Close the traverse by selecting **Close** in the **Sight Foresight** screen after a backsight point measurement, but before the foresight point measurement.

Close Traverse...

Field	Description
F1 ...at Known Station to Known Closing Point	<p>To close a traverse at a known station to a known closing point. Use when setup on the closing station, and the coordinates for the station and the closing point are known.</p> <p> If this method is chosen a distance measurement is mandatory.</p> <ol style="list-style-type: none"> 1. Input the data for both points. 2. Measure to the closing point. 3. The results are displayed.
F2 ...to Known Closing Point	<p>To close a traverse to a known closing point. Use when setup on an unknown station and only the coordinates of the closing point are known.</p> <ol style="list-style-type: none"> 1. Input the data for the point. 2. Measure to the closing point. 3. The results are displayed.
F3 ...at Known Station Only	<p>To close a traverse at a known station only. Use when setup on the closing station and the coordinates for it are known.</p> <ol style="list-style-type: none"> 1. Input the data for the closing station. 2. The results are displayed.
F4 ...Leave Open	<p>To leave the traverse open. There is no last traverse station.</p> <ol style="list-style-type: none"> 1. The results are displayed.

Next step

Select an option, from the **Close Traverse...** menu to proceed to the **Traverse Results** screen.

Traverse Results

Traverse Results	
Result1	Result2
Traverse ID	TRAV_2000
Start Stn.	Stn001
End Stn.	Stn001
No. of Stn.	3
Total Dist.	23.920 m
1D Accuracy	1/13.3612
2D Accuracy	1/4.9479

Adjust | ViewTol | S-Shot | EndTrav

Key	Description
Adjust	To calculate an adjustment. Unavailable when the traverse is left open.
ViewTol	To view the tolerances for the traverse.
S-Shot	To measure a sideshot.
EndTrav	To record the results and end the traverse.

Description of fields

Field	Option	Description
Traverse ID	Display only	Name of the traverse.
Start Stn.	Display only	Point ID of the start station.
End Stn.	Display only	Point ID of the end station.
No. of Stn.	Display only	Number of stations in the traverse.
Total Dist.	Display only	Total distance of the traverse.
1D Accuracy	Display only	Formula: $1 / \left(\frac{\text{Length of Traverse}}{\text{Height Misclosure}} \right)$
2D Accuracy	Display only	Formula: $1 / \left(\frac{\text{Length of Traverse}}{\text{Linear Misclosure}} \right)$
L of Error	Display only	Length/distance error.
Azimuth Err.	Display only	Azimuth closure error.
ΔEast, ΔNorth, ΔHeight	Display only	Calculated coordinates.

Next step

Press **Adjust** from the **Traverse Results** screen to calculate the adjustments.

Set Adjustment Parameter

← Set Adjustment Parameters

Adjust

No. of Stn. 3

Azimuth Err. -----g

Misc.-Distr. **Compass** <>

Height-Distr. Equal <>

Note: Angles adjusted equally!

Scale -----

Use Scale No <>

Cont

Description of fields

Field	Option	Description
No. of Stn.	Display only	Number of stations in the traverse.
Azimuth Err.	Display only	Azimuth closure error.
Misc.-Distr.		For misclosure distribution.
	Compass	Angle misclosures are distributed equally.
	Transit	For surveys where angles and distances were measured with equal precision.
Height-Distr	Selectable list	For surveys where angles were measured with a higher precision than the distances.
Scale	Display only	The height error can be distributed equally, by distance or not at all.
Use Scale	Display only	PPM value defined by the calculated distance between start and end point divided by the distance measured.
Use Scale	Selectable list	Whether to use the calculated ppm.



- Depending on the number of measured points the calculation may take some time. A message is displayed during the processing.
- Adjusted points are stored as fixpoints with an additional prefix, for example point BS-154.B is stored as CBS-154.B.
- After the adjustment, Traverse is exited and the system returns to the **Main Menu**.

Messages

The following are important messages or warnings that may appear.

Messages	Description
Memory is nearly full! Do you want to continue ?	This message occurs if less than 10% of the memory is free. It is not recommended to start a traverse if the memory is almost full. Doing so, may mean that the traverse measurements and the results cannot be saved.
Current job contains an adjusted Traverse. Select a different job!	Only one traverse per job is allowed. Another job must be selected.

Messages	Description
Last traverse not yet finished or processed! Do you want to continue ?	The Traverse app was quit without closing a traverse. The traverse can be continued on a new station, left unfinished, or a new traverse started and the old traverse data overwritten.
Do you really want to start a new traverse ? All existing data will be overwritten!	Confirmation of this message will start a new traverse and the old traverse data will be overwritten.
Redo last station ? Measurements of this station will be overwritten!	Confirming returns to the first sight point screen for the previous station measurements. The data from the last station is not stored.
Exit Traverse application ? Current station data will be lost!!!	Quitting the app returns to the Main Menu . The traverse can be continued later, but the current station data will be lost.
Out of Tolerance!	The tolerance limits have been exceeded. If not accepted, the calculations can be redone.
Traverse points are re-calculated and newly stored...	An information message displayed while the adjustment is calculated.

7.15



Tunnel



Refer to the separate manual "Leica TS03/TS07 Tunnel Application".

8 Favourites

8.1 Overview













Description





Favourites can be accessed by:

Key	Description
	Opens the Favourites Menu and a function can be selected and activated.
 	Activates the specific function assigned to the key. Any function from the Favourites Menu can be assigned to these keys. Refer to "5.1 Work Settings".

Favourites

 The symbol of an unavailable favourite is crossed out.

Favourite	Description
	Returns to the Main Menu .
Home	
	Displays the laser plummet and electronic level. Refer to "Level up with the electronic level step-by-step".
Level	
	Refer to "8.2 Target Offset".
Offset	
	Deletes the last recorded data block. This can be either a measurement block or a code block.
Del.Rec	 Deleting the last record is not reversible! Only records recorded in Survey can be deleted.
	Starts coding to select a code from a codelist or enter a new code. Same functionality as the softkey Code .
Coding	
	Refer to "5.13 Instrument Protection with PIN".
PIN-lock	
	Changes between the two EDM modes. Refer to "5.5 EDM Settings".
NP\leftrightarrowP	
	Activates/deactivates the visible laser beam for illuminating the target point.
Laserpt.	
	Refer to "8.5 EDM Tracking".
EDM Track	
	To view EDM Signal reflection value.
Sig.Refl.	
	Height Transfer. Refer to "7.2 Station Setup".
H-Trans	

Favourite	Description
	Refer to "8.3 Hidden Point".
Hidden Pt	
	Refer to "8.4 Check Tie".
CheckTie	
	Refer to "8.6 Backsight Check".
BS-Check	
	To create a sketch on a virtual piece of paper. Refer to "8.7 SketchPad".
SketchPad	
	To deactivate/activate the touch screen. Available for TS07.
Touch	
Distance Unit	Sets the distance measurement unit. Available for the user keys.

8.2

Target Offset

8.2.1

Overview

Description

This favourite calculates the target point coordinates if it is not possible to set up the reflector, or to aim at the target point directly. The offset values (length, trav. and/or height offset) can be entered. The values for the angles and distances are calculated to determine the target point.

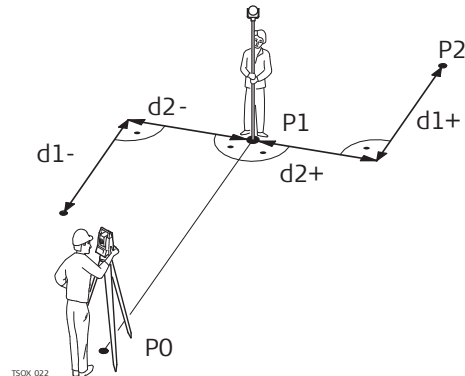

- P0 Instrument station
- P1 Measured point
- P2 Calculated offset point
- d1+ Length offset, positive
- d1- Length offset, negative
- d2+ Trav. offset, positive
- d2- Trav. offset, negative

Access

1. Press the Favourites key when within any app.
2. Select **Offset** from the **Favourites Menu**.



Enter offset values

← Offset  13:47

Values

Enter offset values!

Trav. Off.

Length Off.

Height Off.

Mode

Default | Cylindr | Cont

Key	Description
Default	To reset offset values to 0.
Cylindr	To enter cylindrical offsets.

Description of fields

Field	Option	Description
Trav. Off.		Perpendicular offset. Positive if the offset point is to the right of the measured point.
Length Off.		Longitudinal offset. Positive if the offset point is further away than the measured point.
Height Off.		Height offset. Positive if the offset point is higher than the measured point.
Mode		Period for which the offset is to apply.  The offset values are always reset to 0 when the app is quit.
	Reset after REC	The offset values are reset to 0 after the point is saved.
	Cylindr	The offset values are applied to all further measurements.

- Either, press **Cont** to calculate the corrected values and return to the app from which the offset favourite was started. The corrected angle and distances are displayed as soon as a valid distance measurement has been triggered or exists.
- Or, press **Cylindr** to enter cylindrical offsets. Refer to "8.2.2 Cylindrical Offset".

8.2.2

Cylindrical Offset

Description

Determines the coordinates of the centre point of cylindrical objects and their radius. The horizontal angle to points on both the left and right sides of the object are measured, and the distance to the object as well.

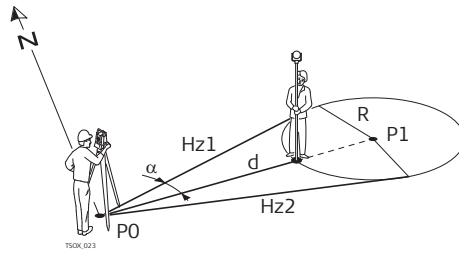

- P0 Instrument station
- P1 Centre point of cylindrical object
- Hz1 Horizontal angle to a point on the left side of the object
- Hz2 Horizontal angle to a point on the right side of the object
- d Distance to the object in the middle between Hz1 and Hz2
- R Radius of cylinder
- α Azimuth from Hz1 to Hz2

Access

Press **Cylindr** from the **Offset** screen.

Cylindrical Offset

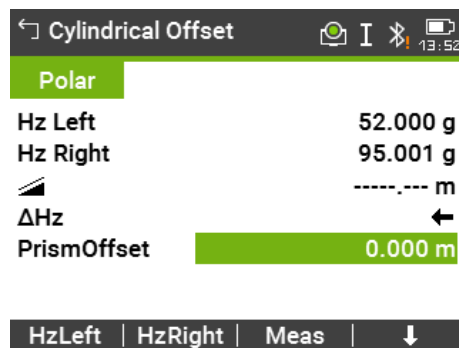

Key	Description
HzLeft	To trigger measurement for the left side of the object.
HzRight	To trigger measurement for the right side of the object.

Description of fields

Field	Option	Description
Hz Left	Display only	Measured horizontal direction to the left side of the object. Using the verticalhair, aim at the left side of the object, then press HzLeft .
Hz Right	Display only	Measured horizontal direction to the right side of the object. Using the verticalhair, aim at the right side of the object, then press HzRight .
ΔHz	Display only	Deviation angle. Rotate the instrument to aim in the direction of the centre point of the cylindrical object, such that ΔHz is zero.
PrismOffset	Editable field	Prism offset distance between the centre of the prism and the surface of the object to be measured. If the EDM mode is Non-Prism, the value is set to zero automatically.

Next step

Once ΔHz is zero, press **Meas** to complete the measurement and display the results.

Cylindrical Offset Result

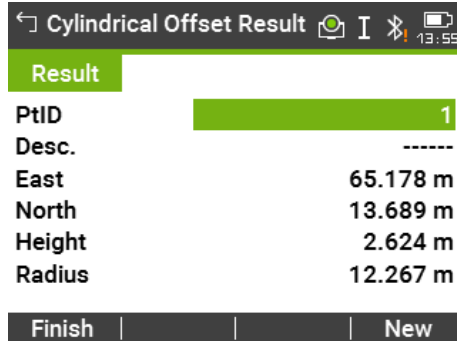

Cylindrical Offset Result	
Result	
PtID	1
Desc.	-----
East	65.178 m
North	13.689 m
Height	2.624 m
Radius	12.267 m
Finish	New

Key	Description
Finish	To record results and return to the main Offset screen.
New	To measure a new cylindrical object.

Description of fields

Field	Option	Description
PtID	Editable field	Defined point ID of the center point.
East	Display only	Easting coordinate of the centre point.
North	Display only	Northing coordinate of the centre point.
Height	Display only	Height of the point measured with the reflector.  This is not the calculated height of the centre point.
Radius	Display only	Radius of the cylinder.

8.3

Hidden Point

Description

This favourite is used for measurements to a point that is not directly visible, using a special hidden point rod.

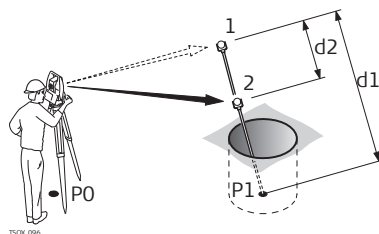

P0 Instrument station

P1 Hidden point

1-2 Prisms 1 and 2

d1 Distance between prism 1 and the hidden point

d2 Distance between prism 1 and 2

Access

1. Press the Favourites key when within any app.
2. Select **Hidden Pt** from the **Favourites Menu**.

3. If necessary, press **Rod/EDM** to define the rod or EDM settings.

Hidden Point - Rod Settings

Description of fields

Field	Option	Description
EDM Mode	Selectable list	Changes the EDM Mode.
Prism Type	Selectable list	Changes the prism type.
PrismConst.	Editable field	Displays the prism constant.
Rod Length	Editable field	Total length of hidden point rod.
Dist. R1-R2	Editable field	Spacing between the centres of the prisms R1 and R2.
Meas. Tol.	Editable field	Limit for the difference between the given and measured spacing of the prisms. If the tolerance value is exceeded, a warning is issued.

Next step

In the **Hidden Point** screen, measure to the first and second prisms using **Meas** and the **Hidden Point Result** screen is displayed.

Hidden Point Result

Displays Easting, Northing and Height coordinates of the hidden point.

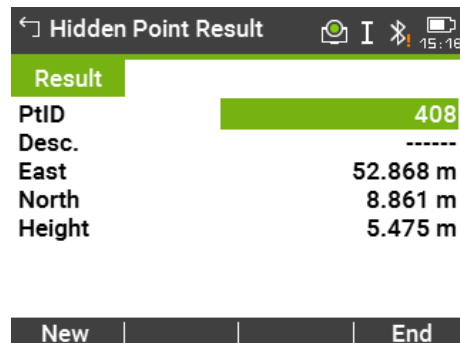

Key	Description
New	To return to the Hidden Point screen.
End	To record results and return to the app where the Favourites key was selected.



8.4

Check Tie

Description

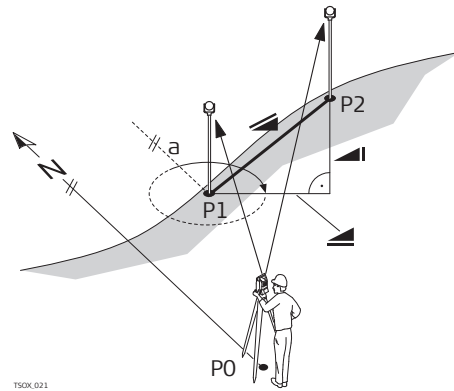
This favourite calculates and displays the slope and horizontal distance, height difference, azimuth, grade, and coordinate differences between the last two measured points. Valid distance measurements are required for the calculation.





- a Azimuth
-  Slope distance
-  Height distance
-  Horizontal distance
- P0 Instrument station
- P1 First point
- P2 Second point

Access

1. Press the Favourites key when within any app.
2. Select **CheckTie** from the **Favourites Menu**.

Check Tie

Description of fields

Field	Option	Description
Bearing	Display only	Difference in bearing between the two points.
Grade	Display only	Difference in gradient between the two points.
	Display only	Difference in horizontal distance between the two points.
	Display only	Difference in slope distance between the two points.
	Display only	Difference in height between the two points.

Messages

The following are important messages or warnings that may appear.

Messages	Description
Two measurements required!	The values cannot be calculated as there are less than two valid measurements.

8.5

EDM Tracking

Access

1. Press the Favourites key when within any app.
2. Select **EDM Track** from the **Favourites Menu**.

Description

This favourite activates or deactivates the tracking measurement mode. The new setting is displayed for about one second and then set. This favourite can only be activated from within the same EDM mode and prism type. The following options are available.

EDM Mode	Tracking mode OFF! <=> Tracking mode ON!
Prism	Precise+ <=> Tracking / Precise&Fast <=> Tracking
Non-Prism	NP-Precise <=> NP-Tracking



The last active measurement mode remains set when the instrument is switched off.

8.6 Backsight Check

Description

This favourite enables the user to remeasure to the point(s) used for Station Setup. This is useful to check if the station position is still correct after measuring some points.

Access

1. Press the Favourites key when within any app.
2. Select **BS-Check** from the **Favourites Menu**.

Backsight Check

This screen is exactly the same as the Setout screen, except that the available PtIDs are restricted to the points used for the last orientation. Refer to "7.4 Setout" for information about the screen.



When setting up a station by local resection, check the coordinate system of the points used from the list.

8.7 SketchPad

Description

The field sketch functionality is used to create a sketch on virtual paper. The sketch is stored as image in bmp format. The bmp file is stored in the \JOBS\IMAGES folder of the internal memory. The predefined template is optimised for A4 printout.

Access









1. Press the Favourites key when within any app.
2. Select **SketchPad** from the **Favourites Menu**.

Notes



Overview of keys,
softkeys and icons for
sketching

Key	Description
Back	To return to the last active screen.
Store	To store and link the field sketch.

Icon	Key or Softkey	Description
	-	To activate sketching. The icon  is displayed:
	-	To quit sketching. The icon  is displayed.
	-	To change the line colour. Tap the icon to open a window displaying line colours for selection. The selected line colour is remembered.
	-	To change the line width. Tap the icon to open a window displaying line widths for selection. The selected line width is remembered.
	-	To undo all changes since the last saving.
	Zoom +	To zoom into the image.
	Zoom -	To zoom out of the image.

9

Coding

9.1

Coding

Description

Codes contain information about recorded points. With the help of coding, points can be assigned to a particular group simplifying later processing. Codes are stored in codelists, with each codelist supporting a maximum of 200 codes.

Creating a codelist

A codelist can be created:

- on the instrument: Select **Manage** from the **Main Menu**. Select **Codes** from the **Manage Menu**.
- in Leica Infinity.

Codelists can be imported and exported via USB memory stick/SD card or copied as file between instrument and PC. Refer to "12.3 Importing Data" and "12.2 Exporting Data".

Number of codes supported in codelists:

- Up to 200, when created using Leica Infinity.

GSI coding

Codes are always stored as free codes (WI41-49), that means that codes are not directly linked to a point. They are stored before or after the measurement depending on the setting made.

A code is always recorded for each measurement as long as the code is displayed in the **Code:** field. For a code not to be recorded, the **Code:** field must be cleared. This can be set to occur automatically. Refer to "5.1 Work Settings".

Access

- To select a code: On **Work Settings, Screen** page, configure the survey display so that a **Code** field is shown. In the survey display, Highlight the **Code** field.
 - Use the right/left navigation key to scroll through the codes.
 - Type in a code. After entry, the firmware searches for a matching code name, and displays these in the code field. If a matching code name does not exist, then a new code name is created.
 - Press **ENTER** to open the codelist.
- To access a list of codes: Press **↓ Code** in **Survey**.

Coding

← Coding 14:06

Code

Enter new code

Code 552

Q-Code 00

Desc. CODEDESC

Info 1 -----

Info 2 -----

Info 3 -----

Cont

Key	Description
Cont	To save the changes.

Description of fields

Field	Option	Description
Code	Editable field	Code name.
Q-Code	Editable field	Two digit quick code assigned to the code. Refer to "9.2 Quick Coding".
Desc.	Editable field	Additional remarks.
Info 1 to Info 8	Editable field	More information lines, freely editable. Used to describe attributes of the code.

Code

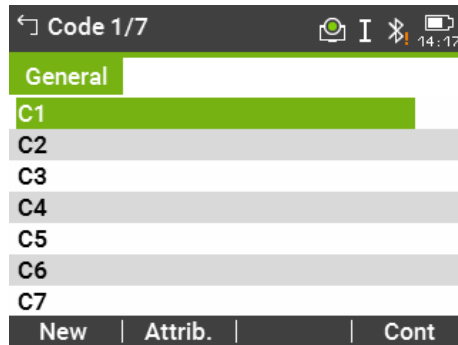

Key	Description
New	To create a new code.
Attrib.	To add up to 8 attributes with up to 16 characters. Existing code attributes can be overwritten with the following exceptions: The codelist editor of Leica Infinity or a special TS Tools collection can assign a status to the attributes. Attributes with status "fixed" are write-protected. They cannot be overwritten or edited. For attributes with status "Mandatory" an input or a confirmation is required. Attributes with status "Normal" can be edited freely.  The *.cls in the \CODES folder of the USB stick or SD card is not changed.
Edit	To edit quick code, description and attributes.

Description of columns

Column	Description
First column	Code name
Second column	Description of the code

9.2



Quick Coding

Description

Using quick coding, a predefined code can be called directly via the keypad on the instrument. The code is selected by entering a two-digit number, the measurement is then triggered and the measured data and code saved. A total of 99 quick codes can be assigned.

The quick code number can be assigned when the code is created in the **Coding** screen, in the Codelist Manager in Leica Infinity or a special TS Tools collection, or it is assigned in accordance with the order in which the codes were entered, for example, 01 -> first code in the code list ... 10 -> tenth code in the code list.

Access

1. Select **Apps** from the **Main Menu**.

2. Select **Survey** from the **Programs Menu**.

3. Press **↓Q-Code**.

Quick coding step-by-step

1. Press **↓Q-Code**.
2. Enter a two-digit number on the keypad.
 A two-digit code must always be entered on the keypad even if only a one-digit code was assigned.
For example: 4 -> enter 04.
3. The code is selected, the measurement triggered and the measured data and code saved. The name of the selected code is displayed after the measurement.
4. Press **↓Q-Code** again to end quick coding.

Messages

The following are important messages or warnings that may appear.

Messages	Description
Cannot edit attribute!	Attribute with fixed status cannot be changed.
No codelist available !	No codelist in memory. Manual input for code and attributes are called automatically.
Code not found!	No code is assigned to the entered number.

10 MapView Interactive Display Feature

10.1 Overview

Description

MapView is an interactive display feature embedded in the firmware. MapView provides a graphical display of the survey elements which allows for a better overall understanding of how the data being used and measured relates to each other.

Depending on the application and where in the application MapView is accessed from, different functionality is available.

The displayed data in all modes of MapView can be shifted by using both the arrow keys and the touchscreen.

10.2 Accessing MapView

Description

The MapView interactive display feature is provided as a page within applications. It is accessed through the application itself. Depending on the application and from where in the application MapView is accessed, different MapView modes are available.

Access

To view points on a map:



In **Survey**, change to the Map page.

To select points from a map - for apps where points can be selected from the database:

Press **Map** in the screen where points must be selected. Use the touch screen to select points.

10.3 Configuring MapView

Access

1. Select **Settings** from the **Main Menu**.

 2. Select **Screen...** from the **Settings Menu**.

 3. Press  to scroll through the screens of available settings.
-

Access from the MapView toolbar

For TS07: Tap the icon on the MapView toolbar.



10.4 MapView Components

10.4.1 Screen Area

Standard screen



- a North arrow
- b Scale bar
- c Toolbar

Scale bar

Symbol	Description
	Scale of the current screen. The minimum is 0.1 m. There is no maximum for the zoom but the scale cannot display values greater than 99000 m. In this case the value displayed will be >99000 m.

North arrow

Symbol	Description
	North arrow. North is always orientated towards the top of the screen.

Toolbar

Symbol	Description
	Icon toolbar. Refer to "10.4.2 Keys, Softkeys and Toolbar" for more information about the functionality of the icons in the toolbar.

Prism

Symbol	Description
	Measured position. The orientation of the instrument is shown as dotted line.

Instrument station

Symbol	Description
	Position of the instrument station.

10.4.2 Keys, Softkeys and Toolbar

Description







Standard functionality is provided by softkeys, keys and a toolbar within MapView.

The softkeys are available regardless of the mode in which MapView was accessed and always perform the same functions.

On the right side of the screen, a toolbar with icons is available. Some functions of the toolbar can also be performed by using a softkey or key instead. Refer to the following table for a description of the toolbar functions and their respective softkey/key equivalents, if available.

Overview of keys, softkeys and icons



The softkeys described in this table are standard on all MapView screens. For descriptions of mode-specific softkeys, see appropriate chapters.





Icon	Key or Softkey	Description
	Fit	The fit icon fits all displayable data, according to filters and the map configuration, into the screen area, using the largest possible scale.
	Zoom +	To zoom into the map.
	Zoom -	To zoom out of the map.
	-	The windowing icon zooms to a specified area window. An area window can be drawn by dragging the stylus on the screen in a diagonal line to make a rectangular area or by tapping twice on the screen to define diagonally opposite corners of a rectangular area. This action causes the screen to zoom to the selected area.
	Ctr.Tgt	To centre the target. Refer to "5.1 Work Settings".
	Ctr.St.	To centre the instrument. Refer to "5.1 Work Settings".
	-	To configure MapView. Refer to "10.3 Configuring MapView".
-	Tap on screen with stylus, hold and move OR Left/right/up/down arrow key	To move the view of a map up and down as well as left and right. This is particularly useful when you have zoomed in on a view, and want to move the view around to see other areas of interest.

10.4.3

Point Symbols

Symbols

Symbol	Description
	Fixpoint. Show in Map: Fixpoints or Show in Map: Meas & Fixpts must be selected in Screen & Audio Settings, Map page.
	Fixpoint active

Symbol	Description
	Calculated station
	Station active
	Measured point. Show in Map: Measurements or Show in Map: Meas & Fixpts must be selected in Screen & Audio Settings, Map page.
	Measured point active

10.5

Selecting a point using the touch screen step-by-step

Selecting Points

Available for TS07.

1. Press **Map** in the screen where points must be selected.
2. Tap on the point to be selected.

 When there are multiple points within the same area and the precise selection is unclear, tapping on the point will access **Points Found**.

3. **Points Found**

The ID and the type of the points within range of the point selection is displayed.

Select the desired point.

 **View** to display the coordinate and job details of the selected point.

4. **Cont** returns to previous screen with the focus on the selected point.

11 Imaging & Sketching

11.1 Screenshot

- Description**
- Screenshots can be taken from the display as additional information in support cases.
 - The images can be linked to the station or to points stored in the job.
- Requirements**
- A TS07 must be used.
 - In **Work Settings, General** page, set **USER Key 1: Screenshot** or **USER Key 2: Screenshot**.

Access Press a user key configured with the option **Screenshot**.

Screenshots

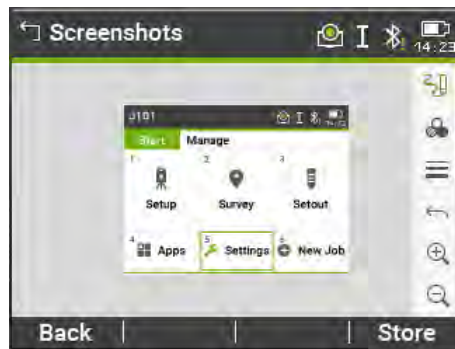

Key	Description
Back	To return to the last active screen.
Store	To store the screenshot with or without sketch. Decide if the screenshot is stored with the station, the last stored point, a selected point or without link.

11.2 Sketching

- Description** Available for TS07.
- A sketch can be overlaid on an image taken from any screen.
- The image with the sketch is stored by pressing **Store**. The sketch is stored together with the image in bmp format. File naming:
Img_ddmmy_hhmmss.bmp









Access step-by-step

- In data management** (the screenshot is already stored and possibly linked)
1. In the **Main Menu**, select the **Manage** page.
 2. Select **ScrShots**.
 3. Select a job.
 4. Press **Cont**.
 5. Click the icon  in the toolbar.

When taking a new screenshot

1. Press a user key configured with the option **Screenshot**.
2. Click the icon  in the toolbar.

Overview of keys, softkeys and icons for sketching

Icon	Key or Softkey	Description
	-	To activate sketching. The icon  is displayed:
	-	To quit sketching. The icon  is displayed.
	-	To change the line colour. Tap the icon to open a window displaying line colours for selection. The selected line colour is remembered.
	-	To change the line width. Tap the icon to open a window displaying line widths for selection. The selected line width is remembered.
	-	To undo all changes since the last saving.
	Zoom +	To zoom into the image.
	Zoom -	To zoom out of the image.

11.3

Image Management

Access

1. In the **Main Menu**, select the **Manage** page.
2. Select **ScrShots**.
3. Select a job.
4. Press **Cont**.

Screenshots

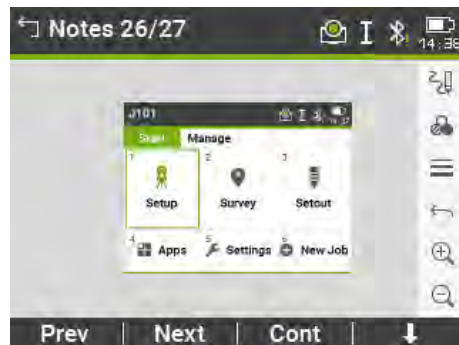

Key	Description
Prev	To display the previous image in the list of images. Available unless the beginning of the list is reached.
Next	To display the next image in the list of images. Available unless the end of the list is reached.
Cont	To store the image with the added link or a sketch created. If no sketch was created, then the image is not stored a second time to avoid a loss of quality.

Key	Description
Delete	To delete the image and all its links.
DelLnk	To delete only a link but not the image. Links can be selected from a list.
Info	To show the file name, job, creation date, modification date and links.
List	To list all images stored in the selected job.

12

Data Management

12.1

Manage







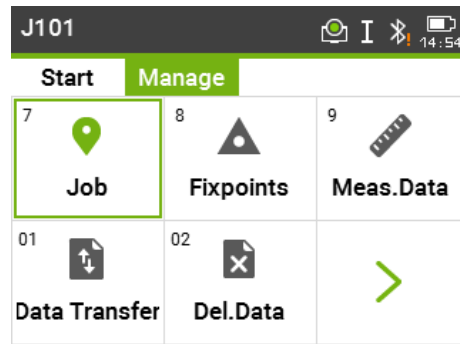

Access





Select the **Manage** page in the **Main Menu**.

Job name, Manage page

The **Manage** page contains all functions for entering, editing, checking and deleting data in the field.



Menu item	Description
 Job	To select, view, create and delete jobs. Jobs are a summary of data of different types, for example, fixed points, measurements or codes. The job definition consists of the job name and user. The system generates time and date at the time of creation.
 Fixpoints	To view, create, edit and delete fixpoints. Valid fixed points contain at least the point ID and the coordinates E, N or H. To select a code from the existing codelist. To view all screenshots linked to the fixpoint.
 Meas.Data	To view, edit and delete measurement data. Measurement data available in the internal memory can be searched for via a specific point search, or by viewing all points within a job. The PtID, hr, code and code details can be edited.  If the details of a point have been edited, any new calculations will use the new point details. However, any previously stored calculation results based on the original coordinates of the point will not be updated.
 Data Transfer	To export and import data. Refer to "12.2 Exporting Data".
 Del.Data	To delete individual jobs, fixpoints and measurements of a specific job or all jobs in the memory.  Deleting the memory cannot be undone. After confirming the message all data is permanently deleted.
	To view, delete, rename and create folders and files stored on the USB memory stick. Only available if a USB memory stick is inserted.

Menu item	Description
USB-Stick	Refer to "12.4 Working with a USB Memory Stick" and "B Directory Structure".
 SD Card	To view, delete, rename and create folders and files stored on the SD card.
 Int. Memory	To view, delete, rename and create folders and files stored on the internal memory. The internal memory has same folder structure like USB stick.
 Codes	To view, create, edit and delete codes. To each code a description and a maximum of 8 attributes with up to 16 characters each can be assigned.
 Formats	To view and delete data format files.
 ScrShots	To view, delete, link, unlink, sketch or view information of screenshots taken and stored. Refer to "11.2 Sketching" for sketching.

12.2

Exporting Data

Description

Job data, format files, configuration sets and codelists can be exported from the internal memory of the instrument. Data can be exported to:

- USB memory stick
- SD card
- Configured interface (Bluetooth, RS232 serial, WLAN)

USB memory stick, SD card

A USB memory stick or SD card can be inserted and removed. No additional software is required for the transfer.

RS232 serial interface

A receiver, such as a laptop, is connected to the RS232 port. The receiver requires Leica Infinity or another third-party software.





If the receiver is too slow in processing data the data could be lost. With this type of data transfer the instrument is not informed about the performance of the receiver (no protocol). Therefore the success of this type of transfer is not checked.

XML Export

The exporting of XML data has some special requirements.

- XML standards do not allow a mix of imperial and metric measurement systems. When exporting XML data, all measurements will be converted to the same measurement system as set for the distance unit. For example, if the distance unit is set to a metric unit (metre), the pressure and temperature units will be converted to metric units as well, even if they are set to imperial units on the instrument.
- The angle unit MIL is not supported by XML. When exporting XML data, measurements using this unit are converted to dec.deg.
- The distance unit ft-in/16 is not supported by XML. When exporting XML data, measurements using this unit are converted to feet.
- Points with Height coordinates only, are not supported by XML. These points are given the E and N values of 0.

Access

1. Select the **Manage** page in the **Main Menu**.
2. Select **Data Transfer**.

3. Select **Export**.

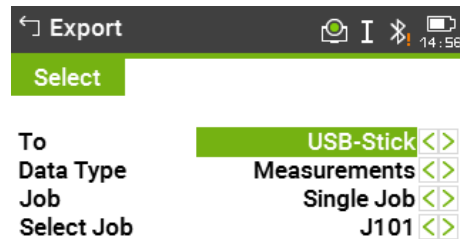
Export



Back | Search | List | Cont

Key	Description
Search	To search for jobs or formats within the internal memory.
List	To list all jobs or formats within the internal memory.

Description of fields

Field	Option	Description
To	Selectable list	Select the memory device.
Data Type		Data type to be transferred Data transfer is possible to:
		USB stick SD card Internal memory RS232 interface
	Measurements	✓ ✓ ✓ ✓
	Fixpoints	✓ ✓ ✓ ✓
	Meas & Fixpts	✓ ✓ ✓ ✓
	Road Data	✓ ✓ ✓ -
	Code	✓ ✓ ✓ -
	Format	✓ ✓ ✓ -

Field	Option	Description
	Configura- tion	✓ ✓ ✓ -
	Backup	✓ ✓ ✓ -
	Images	✓ ✓ ✓ -
Job	Selectable list	Select whether to export all job-related data or a single job data file.
Select Job	Selectable list	Displays the selected job or road alignment file.
Format	Selectable list	If Data Type: Format . Select whether to export all formats or a single format.
Format Name	Editable field	If Format: Single Format . Name of the format to be transferred.

Export data step-by-step

1. Press **Cont** in the **Export** screen after selecting the export details.
2. If export is to a USB memory stick, SD card or internal memory, select the desired file location and press **Cont**.
3. Select the data format, enter the file name and press **Cont** or **Send**.

DXF:	To export data using Leica Infinity. Fixed format (X/Y/Z).
DXF Custom:	To export data using an USB stick. The DXF format is user definable. Continue with step 5..
ASCII:	American Standard Code for Information Interchange . Free format. Use and order of variables and delimiter can be defined during import. Continue with step 4..
GSI:	Leica Geo Serial Interface . Fixed format. Select between three predefined formats. Refer to "5.3 Data Settings" for an explanation of the formats.
XML:	Extensible Markup Language . XML is a recommendation of the World Wide Web Consortium. Fixed format.
HeXML:	Hexagon Extensible Markup Language . HeXML is an extension to the LandXML format. It contains additional information, which is missing in LandXML and relevant for the data exchange in a geospatial environment.

4.

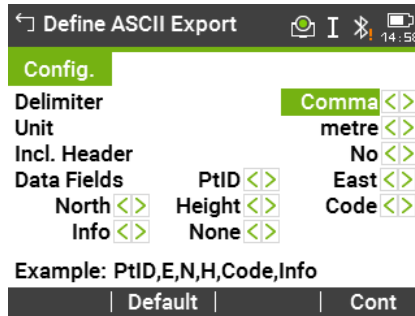

5.

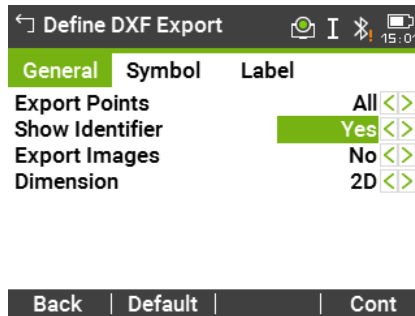

For data format is DXF Custom:

Define the point type export, image export, the X/Y/Z export, the size of the point symbols and the labelling plus coloring of additional point information. Define if identifiers are included for additional point information. Press **Cont**.

Examples:

Exported points without labels:



Exported points with labels:



Exported points with labels and identifier:



6. A message will display confirming the successful export of data.



Measurement data are stored in chronological order – line by line - on the instrument. The XML data format and other format files do not output data chronologically but sort the data in separate blocks. During the data export in XML data format or other format files, the instrument has to search the whole memory until the required data is found. Therefore, the data transfer time varies between formats. The GSI data format has the best transfer speed-performance.



A '+', '-', '.' or alphanumeric characters should not be used as delimiter values in ASCII files. These characters can also be part of the point ID or coordinate values and if so, will generate errors where they occur in the ASCII file.



Road Data, Format and Backup data types, and the **ASCII** data format, are only available for data exports to a USB memory stick, SD card and internal memory. It is not possible via the RS232 serial interface.



All jobs, formats, codelists and configurations will be stored in the backup folder created on the USB memory stick. The job data will be stored as individ-

ual database files for each job, which can then be imported again. Refer to "12.3 Importing Data".

Exportable job data formats

Job data can be exported from a job in dxf, gsi, csv and xml file types, or any other user-defined ASCII format. A format can be defined in the Format Manager of Leica Instrument Tools.

RS232 example job data output

Within the **Data Type** setting **Measurements**, a data set could be shown as follows:

```
11...+00000D19      21..022+16641826      22..022+09635023
31..00+00006649      58..16+00000344      81..00+00003342
82..00-00005736      83..00+00000091      87..10+00001700
```

GSI-IDs		GSI-IDs continued	
11	PtID	41-49	Codes and attributes
21	Horizontal direction	51	ppm [mm]
22	Vertical angle	58	Prism constants
25	Orientation	81-83	(E, N, H) Target point
31	Slope distance	84-86	(E, N, H) Station point
32	Horizontal distance	87	Reflector height
33	Height difference	88	Instrument height

12.3

Importing Data

Description



Data can be imported to the internal memory of the instrument via USB memory stick, SD card or internal memory.

Importable data formats

When importing data, the instrument automatically stores the file in a directory folder based on the file extension. The following data formats can be imported:

Data Type	File extension	Recognised as
GSI	.gsi, .gsi (road)	Fixpoints
DXF	.dxf	Fixpoints
LandXML	.xml	Fixpoints
ASCII	any ASCII file extension e.g. .txt	Fixpoints
Format	.frt	Format file
Codelist	.cls	Codelist file
Configuration	.cfg	Configuration file
Backup	.db	Backup of fixpoints, measurements and configuration

Access

1. Select the **Manage** page in the **Main Menu**.
2. Select **Data Transfer**.

3. Select **Import**.

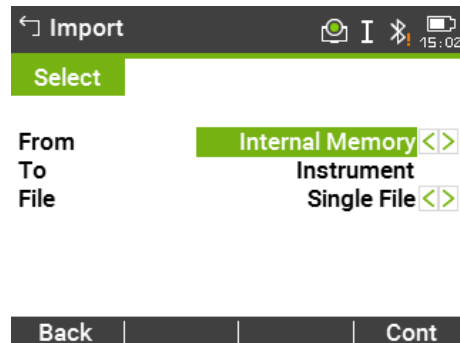
Import



Description of fields

Field	Option	Description
From	Selectable list	Select the memory device.
To	Instrument	Only option
File	Selectable list	Import a single file or a backup folder.



- Importing a backup folder will overwrite the existing configuration file and code lists on the instrument, and all existing formats and jobs will be deleted.
- A backup can only be imported if the instrument database structure was not changed by a firmware update. If the instrument firmware was updated, it can happen that a backup created before the update cannot be imported. In this case, downgrade the firmware to the previous used version, save the data in the way required and then reload the new firmware.

Import data step-by-step

1. Press **Cont** in the **Import** screen to proceed to the file directory of the memory device.
2. Select the file or backup folder to be imported and press **Cont**.
3. For a file: Define the Job name for the imported file, and, if requested, the file definition and layers, and press **Cont** to import. If a Job with the same name already exists in the internal memory, a message will appear with the options to overwrite the existing job, attach the new points to the current job, or rename the job for the file being imported.
If new points are attached to the current job, and the same point ID already exists, the existing point ID will be renamed with a numerical suffix. For example, PointID23 will be renamed to PointID23_1. The maximum renamed suffix is 10, e.g. PointID23_10.
For a backup folder: Take note of the warning message displayed and press **Cont** to proceed and import the folder.

4.

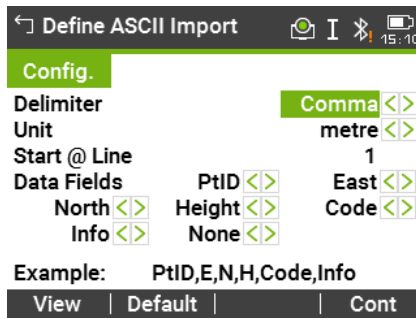

If the file is an ASCII file, the **Define ASCII Import** screen will appear. Define the delimiter value, the units and the data fields of the file and press **Cont** to continue.

5. A message will display once the file or backup folder has been successfully imported.



A '+', '-', '.' or alphanumerical characters should not be used as delimiter values in ASCII files. These characters can also be part of the point ID or coordinate values and if so, will generate errors where they occur in the ASCII file.

12.4

Working with a USB Memory Stick



Always return to the **Main Menu** before removing the USB memory stick.



- Keep the USB memory stick dry.
- Use it only within the specified temperature range, -40°C to +85°C (-40°F to +185°F).
- Protect the USB memory stick from direct impacts.

Failure to follow these instructions could result in data loss and/or permanent damage to the USB memory stick.



Whilst other USB memory sticks may be used, Leica Geosystems recommends Leica industrial grade USB memory sticks and cannot be held responsible for data loss or any other error that may occur when using a non-Leica USB memory stick.

Insert a USB memory stick step-by-step

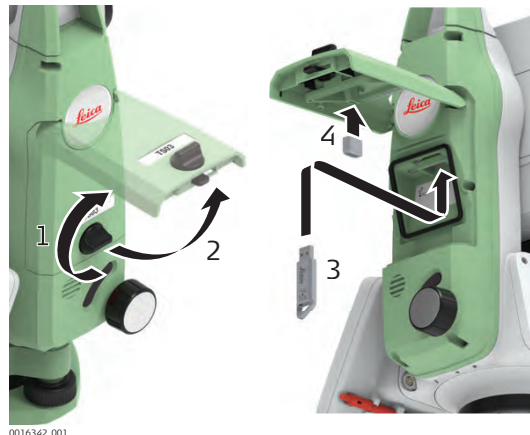



1. Open the compartment lid.
2. The USB host port is located underneath the top edge of the compartment.
3. Insert the USB memory stick into the USB host port.

4. The cap of a Leica industrial grade USB memory stick can be stored on the underside of the compartment lid.
5. Close the compartment lid and turn the knob to lock the compartment closed.

Format an USB memory stick step-by-step

Formatting the USB memory stick before starting to store data is required if a completely new USB memory stick is used, or if all existing data needs to be deleted.

 The formatting function on the instrument only works for Leica USB memory sticks. All other USB memory sticks should be formatted on a computer.

 Despite an automatic defragmentation, the USB memory stick gets fragmented after a while. Please format the USB memory stick periodically to maintain the instrument performance.

1. Select the **Manage** page in the **Main Menu**.

2. Select the **USB-Stick**.



3. Press **↓ Format**.

4. A warning message will appear.

 By activating the format command all data will be lost. Make sure that all important data has been backed up before formatting.

5. Press **Yes**.

6. A message will display once the formatting is completed. Press **Cont**.

12.5

Working with the SD Card



- Keep the card dry.
- Use it only within the specified temperature range.
- Do not bend the card.
- Protect the card from direct impacts.



Failure to follow these instructions could result in data loss and/or permanent damage to the card.

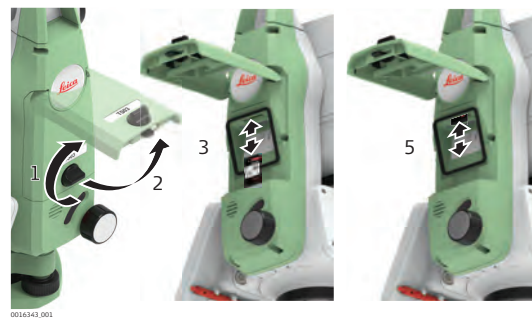

Insert a SD card step-by-step



 The SD card is inserted into a slot inside the compartment below the Leica logo.

1. Turn the knob on the compartment cover to unlock.

2. Open the lid of the compartment.



3. To insert the SD card, slide it firmly into the SD slot until it clicks into position.
 -  The card must be held with the contacts at the top and facing toward the instrument.
 -  Do not force the card into the slot.
4. Close the lid and turn the knob to lock.
5. To remove the SD card, gently press on the top of the card to release it from the slot.

Format an SD card step-by-step

Formatting the SD card before starting to store data is required if a completely new SD card is used, or if all existing data needs to be deleted.

 The formatting function on the instrument only works for Leica SD cards. All other SD cards should be formatted on a computer.

 Despite an automatic defragmentation, the SD card gets fragmented after a while. Please format the SD card periodically to maintain the instrument performance.

1. Select the **Manage** page in the **Main Menu**.
2. Select the **SD Card**.

3. Press **↓ Format**.
4. A warning message will appear.
 -  By activating the format command all data will be lost. Make sure that all important data has been backed up before formatting.
5. Press **Yes**.
6. A message will display once the formatting is completed. Press **Cont**.



12.6

Format the internal memory stick step-by-step

Working with the Internal Memory

Formatting the internal memory before starting to store data is required if all existing data needs to be deleted.

 Despite an automatic defragmentation, the internal memory gets fragmented after a while. Please format the internal memory periodically to maintain the instrument performance.

1. Select the **Manage** page in the **Main Menu**.
2. Select the **Int. Memory**.

3. Press **↓ Format**.
4. A warning message will appear.
 -  By activating the format command all data will be lost. Make sure that all important data has been backed up before formatting.
5. Press **Yes**.
6. A message will display once the formatting is completed. Press **Cont**.

12.7

Working with Bluetooth

Description

Instruments can communicate with external devices via a Bluetooth connection. The instrument Bluetooth is a slave only. The Bluetooth of the external device will be the master, and therefore will control the connection and any data transfer.

Establishing a connection step-by-step

1. On the instrument ensure that the communication parameters are set to **Bluetooth**. Refer to "5.6 Interface Settings".
2. Activate Bluetooth on the external device. The steps required depend on the Bluetooth driver and other device specific configurations. Refer to the device user manual for information on how to configure and search for a Bluetooth connection. The instrument will appear on the external device as "TS0x_y_zzzzzz", where x = the series (TS07), y = the angular accuracy in arc seconds, and z = the serial number of the instrument. For example, TS07_3_1234567.
3. Some devices ask for the identification number of the Bluetooth. The default number for a TS07 Bluetooth is 0000.
4. The instrument Bluetooth sends out the instrument name and serial number to the external Bluetooth device.
5. All further steps must be made in accordance to the user manual of the external device.

12.8

Working with the SIM Card



- Keep the card dry.
- Use it only within the specified temperature range.
- Do not bend the card.
- Protect the card from direct impacts.



Failure to follow these instructions could result in data loss and/or permanent damage to the card.

Insert a SIM card step-by-step



0016651_001



The SIM card is inserted into a slot behind the lid with the logo, almost in the middle of the housing.

1. Turn the knob on the lid to unlock.
2. Open the lid.

3. Hold the SIM card with the contacts facing to the instrument and the cut edge of SIM card facing downwards.
 Sliding in the SIM card differently could break the SIM card holder of the instrument.

 4. Slide the SIM card firmly into the slot until it clicks into position.

 5. Close the lid. Turn to lock.

 6. To remove the SIM card, gently press on the top of the card to release it from the slot.
-

13

Check & Adjust

13.1

Overview

Description

Leica Geosystems instruments are manufactured, assembled and adjusted to the best possible quality. Quick temperature changes, shock or stress can cause deviations and decrease the instrument accuracy. It is therefore recommended to check and adjust the instrument from time to time. This check and adjust can be done in the field by running through specific measurement procedures. The procedures are guided and must be followed carefully and precisely as described in the following chapters. Some other instrument errors and mechanical parts can be adjusted mechanically.

Electronic adjustment

The following instrument errors can be checked and adjusted electronically:

- Horizontal collimation error, also called line-of-sight error.
- Vertical index error, and simultaneously the electronic level.
- Compensator longitudinal and transversal index errors
- Tilting axis error.

Checking parts

The following instrument parts can be checked:

- Circular level on the instrument and tribrach.
- Laser plummet.
- Screws on the tripod.



During the manufacturing process, the instrument errors are carefully determined and set to zero. As mentioned, these errors can change and it is highly recommended to redetermine them in the following situations:

- Before the instrument is used for the first time.
- Before every high precision survey.
- After rough or long periods of transport.
- After long periods of work or storage.
- If the temperature difference between current environment and the temperature at the last calibration is more than 10°C (18°F).

13.2

Preparation

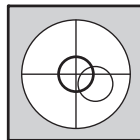

Before determining the instrument errors, the instrument has to be levelled using the electronic level.

The tribrach, the tripod and the underground should be stable and secure from vibrations or other disturbances.



The instrument should be protected from direct sunlight to avoid thermal warming.

It is also recommended to avoid strong heat shimmer and air turbulence. The best conditions are early in the morning or with overcast sky.



Before starting to work, the instrument has to become acclimatised to the ambient temperature. Approximately two minutes per °C of temperature differ-

ence from storage to working environment, but at least 15 min, should be taken into account.

13.3

Adjusting Line-of-Sight and Vertical Index Error



The procedures and conditions required to correct line-of-sight and vertical index errors are the same, therefore the procedure will only be described once.

Line-of-sight error

The line-of-sight error, or horizontal collimation error is the deviation from the perpendicular between the tilting axis and the line of sight.

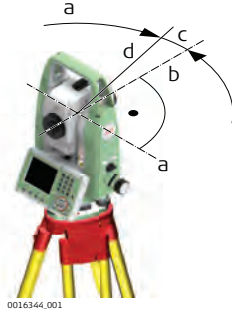

- a Tilting axis
- b Line perpendicular to tilting axis
- c Horizontal collimation, or line-of-sight, error
- d Line-of-sight

Vertical index error

A vertical index error exists, if the 0° mark of the vertical circle reading does not coincide with the mechanical vertical axis of the instrument, also called standing axis.

The V index error is a constant error that affects all vertical angle readings.

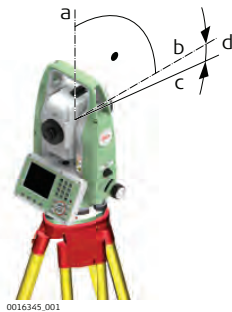



- a Mechanical vertical axis of the instrument, also called standing axis
- b Axis perpendicular to the vertical axis. True 90°
- c Vertical angle is reading 90°
- d Vertical index error



By determining the vertical index error the electronic level is adjusted automatically.

Access

1. Select **Settings** from the **Main Menu**.

2. On the **Tools** page, select **Adjust**.

3. Select:
 - **Hz-Collimation**, or
 - **Vertical Index**.

Check and adjust step-by-step

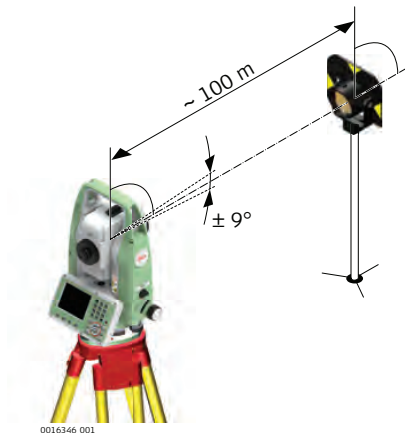
1. Level the instrument with the electronic level. Refer to "4 Operation"- "Level up with the electronic level step-by-step".

2. Aim at a point approximately 100 m from the instrument which is within 5° of the horizontal.



3. Press **Store** to measure to the target point.

4. Change face and aim at the target point again

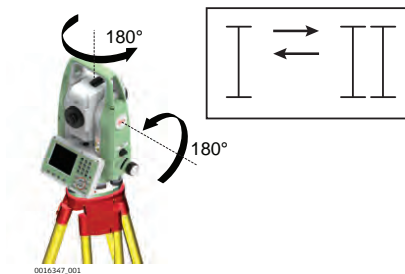

For checking the horizontal aim, the difference in Hz and V are displayed.

5. Press **Store** to measure to the target point.



The old and new calculated values are displayed.

6. Either:
 - Press **More** to measure another set to the same target point. The final adjustment values will be the calculated average from all the measurements.
 - Press **Cont** to save the new adjustment data, or
 - Press **ESC** to exit without saving the new adjustment data.

Messages

The following are important messages or warnings that may appear.

Messages	Description
V-Angle is not suitable for adjustment or wrong face!	The vertical angle deviates from the required horizontal / line-of-sight. Aim correctly at the target point. Confirmation of the message required.
Out of Tolerance! Previous values retained!	Computed values out of tolerance. The previous values are retained and measurements should be repeated. Confirmation of the message required.

Messages	Description
H_z-Angle is not suitable for adjustment!	Horizontal angle in face II deviates by more than 5° from the target point. Aim on the target point with an accuracy of min. 5°. Confirmation of the message required.
Timelimit exceeded! Please repeat Adjustment!	Time difference between measurements for results storage exceeds 15 minutes. Repeat the process. Confirmation of the message required.

13.4

Adjusting the Compensator

Compensator index error

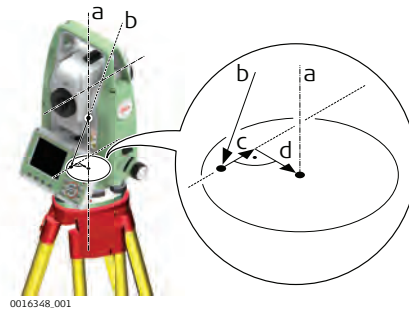

- a Mechanical vertical axis of the instrument, also called standing axis
- b Plumb line
- c Longitudinal component (l) of the compensator index error
- d Transversal component (t) of the compensator index error



The compensator index errors (l, t) occur, if the vertical axis of the instrument and the plumb line are parallel but the zero points of the compensator and the circular level do not coincide. The calibration procedure electronically adjusts the zero point of the compensator.

A longitudinal component in direction of the telescope and a transversal component perpendicular to the telescope define the plane of the dual axis compensator of the instrument.

The longitudinal compensator index error (l) has a similar effect as the vertical index error and effects all vertical angle readings.

The transversal compensator index error (t) is similar to the tilting axis error. The effect of this error to the horizontal angle readings is 0 at the horizon and increases with steep sightings.

Access

1. Select **Settings** from the **Main Menu**.

2. On the **Tools** page, select **Adjust**.

3. Select **Comp. Index**.

Check and adjust step-by-step

1. Level the instrument with the electronic level. Refer to "4 Operation" - "Level up with the electronic level step-by-step".
2. Press **Store** to measure the first face. No target has to be aimed at.
3. **Store** to release the measurement in the other face.

 If one or more errors are bigger than the predefined limits, the procedure must be repeated. All measurements of the current run are rejected and are not averaged with the results from previous runs.

4. Measure the target.
The standard deviations of the determined adjustment errors can be calculated from the second run onwards.

13.5

Adjusting the Tilting Axis Error



Description

The tilting axis error is caused by the deviation between the mechanical tilting axis and the line perpendicular to the vertical axis. This error affects horizontal angles. To determine this error, it is necessary to point to a target located significantly below or above the horizontal plane.



The horizontal collimation error has to be determined before starting this procedure.

Access

1. Select **Settings** from the **Main Menu**.

2. On the **Tools** page, select **Adjust**.

3. Select **Tilt Axis**.

Check and adjust step-by-step

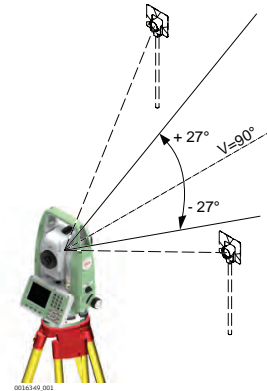
1. Level the instrument with the electronic level. Refer to "4 Operation" - "Level up with the electronic level step-by-step".

2. Aim at a point approximately 100 m from the instrument which is at least 27° (30 gon) above or beneath the horizontal plane.



3. Press **Store** to measure to the target point.
4. Change face and aim at the target point again

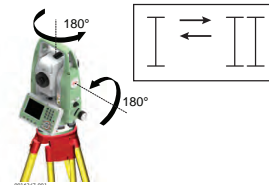

For checking the horizontal aim, the difference in Hz and V are displayed.

5. Press **Store** to measure to the target point.



The old and new calculated values are displayed.

6. Either:
 - Press **More** to measure another set to the same target point. The final adjustment values will be the calculated average from all the measurements.
 - Press **Cont** to save the new adjustment data, or
 - Press **ESC** to exit without saving the new adjustment data.

Messages

The same messages or warning as in "13.3 Adjusting Line-of-Sight and Vertical Index Error" may appear.

13.6

Adjusting the Circular Level of the Instrument and Tribach

Adjust the circular level step-by-step

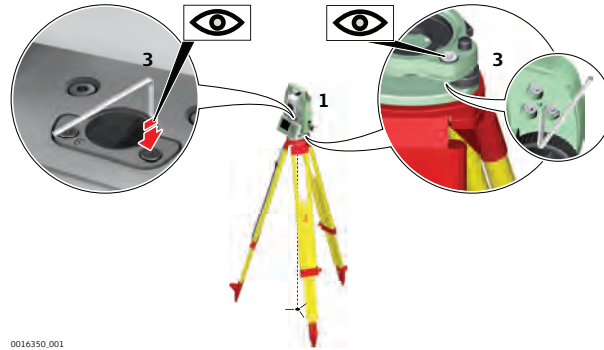

1. Place and secure the tribach onto the tripod, and then secure the instrument onto the tribach.
2. Using the tribach footscrews, level the instrument with the electronic level. To activate the electronic level, turn on the instrument, and, if tilt correction is set to **On**, the **Level & Plummet** screen appears automatically. Alternatively, press the  key from within any app and select **Level**.
3. The bubbles of the instrument and tribach levels must be centred. If one or both circular levels are not centred, adjust as follows.

Instrument: If the bubble extends beyond the circle, use the Allen key supplied to centre it with the adjustment screws.

Tribach: If the bubble extends beyond the circle, adjust it using the adjustment pin in conjunction with the adjustment screws. Turn the adjustment screws:

 - To the left: and the bubble approaches the screw.
 - To the right: and the bubble goes away from the screw.
4. Repeat step 3. on the instrument and tribach until both circular levels are centred and no further adjustments are necessary.



After the adjustment, no adjustment screw should be loose.

13.7

Adjusting the Circular Level of the Prism Pole

Adjusting the circular level step-by-step

1. Suspend a plumb line.
2. Use a pole bipod, to align the prism pole parallel to the plumb line.
3. Check the position of the circular level on the prism pole.
4.
 - a If the circular level is centred, no adjustment is necessary.
 - b If the circular level is not centred, use an allen key to centre it with the adjustment screws.

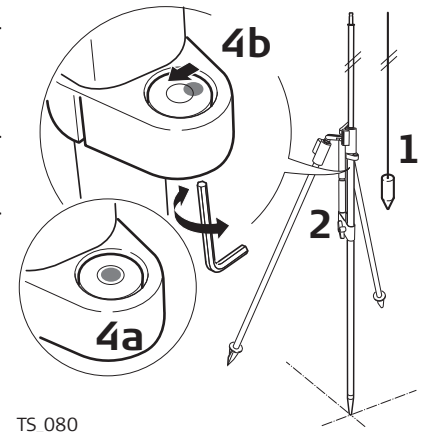

☞ After the adjustments, all adjusting screws must have the same tightening tension and no adjusting screw should be loose.

13.8

Inspecting the Laser Plummet of the Instrument



The laser plummet is located in the vertical axis of the instrument. Under normal conditions of use, the laser plummet does not need adjusting. If an adjustment is necessary due to external influences, return the instrument to any Leica Geosystems authorised service workshop.

Inspect the laser plummet step-by-step

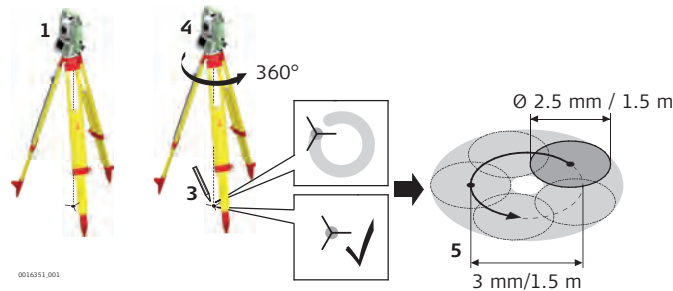

1. Set up the instrument on the tripod approximately 1.5 m above the ground and level up.
2. To activate the laser plummet, turn on the instrument, and, if tilt correction is set to **On**, the laser plummet will be activated automatically, and the **Level & Plummet** screen appears. Otherwise, press the  key from within any app and select **Level**.

☞ Inspection of the laser plummet should be carried out on a bright, smooth and horizontal surface, such as a sheet of paper.

3. Mark the centre of the red laser dot on the ground.
4. Turn the instrument slowly through 360°, carefully observing the movement of the red laser dot.



The maximum diameter of the circular movement described by the centre of the laser dot should not exceed 3 mm at a height of 1.5 m.

5. If the centre of the laser dot describes a perceptible circular movement or moves more than 3 mm away from the point which was first marked, an adjustment may be required. Inform your nearest Leica Geosystems authorised service centre. Depending on brightness and surface, the diameter of the laser dot can vary. At 1.5 m, it is about 2.5 mm.

13.9

Servicing the Tripod

Servicing the tripod step-by-step

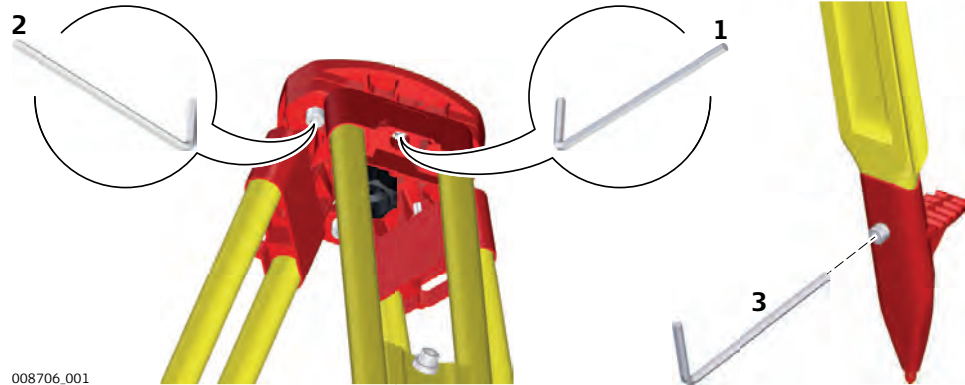

The following table explains the most common settings.



The connections between metal and timber components must always be firm and tight.

- | | |
|----|---|
| 1. | Tighten the leg cap screws moderately, with the supplied allen key. |
| 2. | Tighten the articulated joints on the tripod head enough to keep the tripod legs open when lifting the tripod off the ground. |
| 3. | Tighten the allen screws of the tripod legs. |

Description

mySecurity is a cloud-based theft protection. A locking mechanism ensures that the instrument is disabled and can no longer be used. A Leica Geosystems service centre will inform local authorities if such an instrument turns up.

mySecurity is activated in myWorld.

Adding/removing instruments to/from mySecurity

1. Go to myWorld@Leica Geosystems (<https://myworld.leica-geosystems.com>).
-  You must add your instruments to **myProducts** first, before the instruments can be added to mySecurity.
2. Select **myTrustedServices/mySecurity**.
Available information for listed instruments:
 - Activation date of the mySecurity service
 - Renewal date of the mySecurity service
 - Stolen status, in case of the instrument has been flagged as stolen
3. Click **Add** to add an instrument to mySecurity. Select the instrument from the selectable list. Click **OK**.
4. Select an instrument. Click **Remove** to delete the instrument from mySecurity.





Activating the theft protection

For an active theft protection, the instrument must be connected to myWorld within a defined time interval.

If the instrument is not connected within the defined interval, then the instrument is blocked and cannot be used. In this case, the instrument must be connected to myWorld again and the theft protection must be reactivated.

1. Click the check box to select an instrument.
2. Click **Details**.
3. For **New mySecurity Renewal**, set the start date of the theft protection. Click **In 3 months**, **In 6 months** or **In 12 months** to define the connection interval.
4. Click **Set**.
5. Download and install the mySecurity Online Update program.
6. The program scans for the instrument connection port automatically. In case automatic scanning fails, click **Scan** for a search of the port. Select the connection settings.
7. Click **Connect**.
After the activation, the end date of the theft protection is displayed in the mySecurity Online Update program and on the instrument.
8. Press **Close**.
9. Click the Refresh button to update the screen information.
10. Check the status, the activation date and the renewal date of the theft protection.

Status information on the instrument

1. Select **Settings** from the **Main Menu**.

2. On the **Tools** page, select **Info**.

3. Go to page 4/4 or **Dates**.
4. **mySec.Renewal Date:**
Displays the date when the instrument must be connected to mySecurity. The date is transferred from myWorld to the instrument.
 Ten days before the **mySec.Renewal Date**, a reminder message is displayed each time the instrument is turned on.
 When the **mySec.Renewal Date** has been exceeded, a message informs about the instrument lock. Go to myWorld to renew the theft protection.

Report stolen instrument

1. Go to myWorld@Leica Geosystems (<https://myworld.leica-geosystems.com>).
2. Select **myTrustedServices/mySecurity**.
3. Click the check box to select an instrument.
4. Click **Details**.
5. In the **General** section, click **Report as Stolen**.
6. A warning comes up to confirm device as stolen. Click **OK**.
7. The **Status** of the instrument changes to **Stolen!**.
A Leica Geosystems service centre informs local authorities if such an instrument turns up.

Locate stolen instrument

If a reported, stolen instrument is registered to myWorld, then the IP address of the computer is logged. The IP address is used to locate the instrument.

In **myWorld/myTrustedServices/mySecurity**, the **Status** of the instrument changes to **Located**.

Clicking **Show Location** shows:

- The date and time when the instrument was located
- The IP address of the computer
- A link to show the location on a map

15 Care and Transport

15.1 Transport

Transport in the field	<p>When transporting the equipment in the field, always make sure that you</p> <ul style="list-style-type: none">• either carry the product in its original container,• or carry the tripod with its legs splayed across your shoulder, keeping the attached product upright.
Transport in a road vehicle	<p>Never carry the product loose in a road vehicle, as it can be affected by shock and vibration. Always carry the product in its container and secure it.</p> <p>For products for which no container is available use the original packaging or its equivalent.</p>
Shipping	<p>When transporting the product by rail, air or sea, always use the complete original Leica Geosystems packaging, container and cardboard box, or its equivalent, to protect against shock and vibration.</p>
Shipping, transport of batteries	<p>When transporting or shipping batteries, the person responsible for the product must ensure that the applicable national and international rules and regulations are observed. Before transportation or shipping, contact your local passenger or freight transport company.</p>
Field adjustment	<p>Exposing the product to high mechanical forces, for example through frequent transport or rough handling, or storing the product for a long time may cause deviations and a decrease in the measurement accuracy. Periodically carry out test measurements and perform the field adjustments indicated in the User Manual before using the product.</p>

15.2 Storage

Product	<p>Respect the temperature limits when storing the equipment, particularly in summer if the equipment is inside a vehicle. Refer to "16 Technical Data" for information about temperature limits.</p>
Li-Ion batteries	<ul style="list-style-type: none">• Refer to "16 Technical Data" for information about storage temperature range.• Remove batteries from the product and the charger before storing.• After storage recharge batteries before using.• Protect batteries from damp and wetness. Wet or damp batteries must be dried before storing or use.• A storage temperature range of 0 °C to +30 °C / +32 °F to +86 °F in a dry environment is recommended to minimize self-discharging of the battery.• At the recommended storage temperature range, batteries containing a 40% to 50% charge can be stored for up to one year. After this storage period the batteries must be recharged.

15.3

Cleaning and Drying

Product and accessories

- Blow dust off lenses and prisms.
 - Never touch the glass with your fingers.
 - Use only a clean, soft, lint-free cloth for cleaning. If necessary, moisten the cloth with water or pure alcohol. Do not use other liquids; these may attack the polymer components.
-

Fogging of prisms

Prisms that are cooler than the ambient temperature tend to fog. It is not enough simply to wipe them. Keep them for some time inside your jacket or in the vehicle to allow them to adjust to the ambient temperature.

Damp products

Dry the product, the transport container, the foam inserts and the accessories at a temperature not greater than 40°C /104°F and clean them. Remove the battery cover and dry the battery compartment. Do not repack until everything is completely dry. Always close the transport container when using in the field.

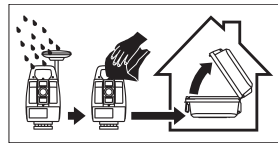

Cables and plugs

Keep plugs clean and dry. Blow away any dirt lodged in the plugs of the connecting cables.

16

Technical Data

16.1

Angle Measurement

Accuracy

Available angular accuracies ["]	Standard deviation Hz, V, ISO17123-3 [mgon]	Display resolution			
		["]	[°]	[mgon]	[mil]
1	0.3	0.1	0.0001	0.1	0.01
2	0.6	0.1	0.0001	0.1	0.01
3	1.0	0.1	0.0001	0.1	0.01
5	1.5	0.1	0.0001	0.1	0.01
7	2	0.1	0.0001	0.1	0.01

Characteristics

Absolute, continuous, diametric. Updates each 0.1 to 0.3 s.

16.2

Distance Measurement with Reflectors

Range

Reflector	Range A		Range B		Range C	
	[m]	[ft]	[m]	[ft]	[m]	[ft]
Standard prism (GPR1)	1800	6000	3000	10000	3500	12000
3 prisms (GPR1)	2300	7500	4500	14700	5400	17700
360° prism (GRZ4, GPZ122)	800	2600	1500	5000	2000	7000
Reflector tape 60 mm x 60 mm						
Prism mode	150	500	250	800	250	800
Non-prism mode, R500	300	1000	500	1600	>500	>1600
Non-prism mode, R1000	600	1950	1000	3300	>1000	>3300
Mini prism (GMP101)	800	2600	1200	4000	2000	7000
360° Mini prism (GRZ101)	450	1500	800	2600	1000	3300
Shortest measuring distance:			1.5m			

Atmospheric conditions

Range	Description
A	Strong haze, visibility 5km; or strong sunlight, severe heat shimmer
B	Light haze, visibility about 20km; or moderate sunlight, slight heat shimmer
C	Overcast, no haze, visibility about 40km; no heat shimmer

Accuracy

Accuracy refers to measurements to standard reflectors.

Distance measuring mode	std. dev. ISO 17123-4, standard prism	std. dev. ISO 17123-4, tape	Measurement time, typical [s]
Precise+	1 mm + 1.5 ppm	3 mm + 2 ppm	2.4
Precise&Fast	2 mm + 1.5 ppm	3 mm + 2 ppm	2.0
Tracking	3 mm + 1.5 ppm	3 mm + 2 ppm	< 0.15
Average	1 mm + 1.5 ppm	1 mm + 1.5 ppm	-

Beam interruptions, severe heat shimmer and moving objects within the beam path can result in deviations of the specified accuracy.

Characteristics

Type	Description
Principle	Phase measurement
Type	Coaxial, visible red laser
Carrier wave	658 nm
Measuring system	System Analyzer Basis 100 MHz - 150 MHz

16.3

Distance Measurement without Reflectors (Non-Prism mode)

Range

Pinpoint R500 (without reflector)

Kodak Gray Card	Range D		Range E		Range F	
	[m]	[ft]	[m]	[ft]	[m]	[ft]
White side 90% reflective	250	820	500	1640	>500	>1640
Grey side 18% reflective	100	330	150	490	>200	>820

Pinpoint R1000 (without reflector)

Kodak Gray Card	Range D		Range E		Range F	
	[m]	[ft]	[m]	[ft]	[m]	[ft]
White side 90% reflective	800	2630	1000	3280	>1000	>3280
Grey side 18% reflective	400	1320	500	1640	>500	>1640
Range of measurement:	1.5 m to 1200 m					
Display unambiguous:	up to 1200 m					

Atmospheric conditions

Range	Description
D	Object in strong sunlight, severe heat shimmer
E	Object in shade, or overcast
F	Underground, night and twilight

Accuracy

Standard measuring	ISO17123-4	Measure time, typical [s]	Measure time, maximum [s]
0m - 500m	2 mm + 2 ppm	3 - 6	15
>500m	4 mm + 2 ppm	3 - 6	15

Beam interruptions, severe heat shimmer and moving objects within the beam path can result in deviations of the specified accuracy.

Tracking measuring*	Standard deviation	Measure time, typical [s]
Tracking	5 mm + 3 ppm	0.25

* Accuracy and measure time depend on atmospheric conditions, target object and observation situation.

Characteristics

Type	Description
Type	Coaxial, visible red laser
Carrier wave	658 nm
Measuring system	System Analyzer Basis 100 MHz - 150 MHz

Laser dot size

Distance [m]	Laser dot size, approximately [mm]
at 30	7 x 10
at 50	8 x 20
at 100	16 x 25

16.4**Distance Measurement Reflector (>4.0km)****Range**

R500, R1000	Range A		Range B		Range C	
	[m]	[ft]	[m]	[ft]	[m]	[ft]
Standard prism (GPR1)	2200	7300	7500	24600	>10000	>33000
Reflector tape 60 mm x 60 mm	600	2000	1000	3300	1300	4200
Range of measurement:	From 1000 m up to 12000 m					
Display unambiguous:	Up to 12 km					

Atmospheric conditions

Range	Description
A	Strong haze, visibility 5km; or strong sunlight, severe heat shimmer
B	Light haze, visibility about 20km; or moderate sunlight, slight heat shimmer
C	Overcast, no haze, visibility about 40km; no heat shimmer

Accuracy

Measurement Mode	ISO17123-4	Measure time, typical [s]	Measure time, maximum [s]
P-Long (>4.0 km)	5 mm + 2 ppm	2.5	12

Beam interruptions, severe heat shimmer and moving objects within the beam path can result in deviations of the specified accuracy.

Characteristics

Type	Description
Principle	Phase measurement
Type	Coaxial, visible red laser
Carrier wave	658nm
Measuring system	System Analyzer Basis 100MHz - 150MHz

16.5

Conformity to National Regulations

16.5.1

TS03

Conformity to national regulations

For products without radio transmitter or receiver:

- FCC Part 15 (applicable in US)



- Hereby, Leica Geosystems AG declares that the product/s is/are in compliance with the essential requirements and other relevant provisions of the applicable European Directives.

The full text of the EU declaration of conformity is available at the following Internet address:
<http://www.leica-geosystems.com/ce>.

16.5.2

TS07

Conformity to national regulations

- FCC Part 15 (applicable in US)
- Hereby, Leica Geosystems AG declares that the radio equipment type TS07 is in compliance with Directive 2014/53/EU and other applicable European Directives.

The full text of the EU declaration of conformity is available at the following Internet address: <http://www.leica-geosystems.com/ce>.



Class 1 equipment according to European Directive 2014/53/EU (RED) can be placed on the market and be put into service without restrictions in any EEA member state.

- The conformity for countries with other national regulations not covered by the FCC part 15 or European Directive 2014/53/EU has to be approved prior to use and operation.
- Japanese Radio Law and Japanese Telecommunications Business Law Compliance.
 - This device is granted pursuant to the Japanese Radio Law (電波法) and the Japanese Telecommunications Business Law (電気通信事業法).
 - This device should not be modified (otherwise the granted designation number will become invalid).

Frequency band

Type	Frequency band [MHz]
TS07, Bluetooth	2402 - 2480
TS07, WLAN	2400 - 2473, channel 1 to 11

Output power

Type	Output power [mW]
Bluetooth	< 10
WLAN (802.11b)	50
WLAN (802.11gn)	32

Antenna

Type	Antenna	Gain [dBi]	Connector
Bluetooth/WLAN	Internal Patch antenna	2 max.	-
GSM/UMTS/LTE	Internal antenna	2 max.	-

16.5.3

Dangerous Goods Regulations

Dangerous Goods Regulations

Many products of Leica Geosystems are powered by Lithium batteries.

Lithium batteries can be dangerous under certain conditions and can pose a safety hazard. In certain conditions, Lithium batteries can overheat and ignite.

☞ When carrying or shipping your Leica product with Lithium batteries onboard a commercial aircraft, you must do so in accordance with the **IATA Dangerous Goods Regulations**.

☞ Leica Geosystems has developed **Guidelines** on "How to carry Leica products" and "How to ship Leica products" with Lithium batteries. Before any transportation of a Leica product, we ask you to consult these guidelines on our web page (<http://www.leica-geosystems.com/dgr>) to ensure that you are in accordance with the IATA Dangerous Goods Regulations and that the Leica products can be transported correctly.

☞ Damaged or defective batteries are prohibited from being carried or transported onboard any aircraft. Therefore, ensure that the condition of any battery is safe for transportation.

16.6

General Technical Data of the Product

Telescope

Type	Value
Magnification	30 x
Free Objective aperture	40 mm
Focusing	1.55 m/5.08 ft to infinity
Field of view	1°30'/1.66 gon. 2.7 m at 100 m

Compensation

Angular accuracy	Setting accuracy		Setting range	
	["]	[mgon]	[°]	[gon]
1	0.5	0.2	±4	0.07
2	0.5	0.2	±4	0.07
3	1	0.3	±4	0.07
5	1.5	0.5	±4	0.07
7	2	0.7	±4	0.07

Level

Type	Value
Circular level sensitivity	6'/2 mm
Electronic level resolution	2"

Control unit

Type	Description
TS03 (Greyscale) and TS07 (Color&Touch):	640 x 480 pixels (VGA), 9 lines, keyboard illumination

Instrument ports

Name	Description
RS232	5 pin LEMO-0 for power, communication, data transfer This port is located on the rotation part of the instrument.
SD card port	SD card port for data transfer
USB host port	USB memory stick port for data transfer
USB device port	Cable connections from USB devices for communication and data transfer
Bluetooth	Bluetooth connections for communication and data transfer
WLAN (TS07)	WLAN connection for Internet access, communication and data transfer
LTE (optional)	Internet access

Pin assignments of the 5 Pin LEMO-0 port



- a Pin 1: Power input
- b Pin 2: not used
- c Pin 3: Single ground
- d Pin 4: RxD
(RS232, receive data, In)
- e Pin 5: TxD
(RS232, transmit data, Out)

Instrument dimensions

TS03

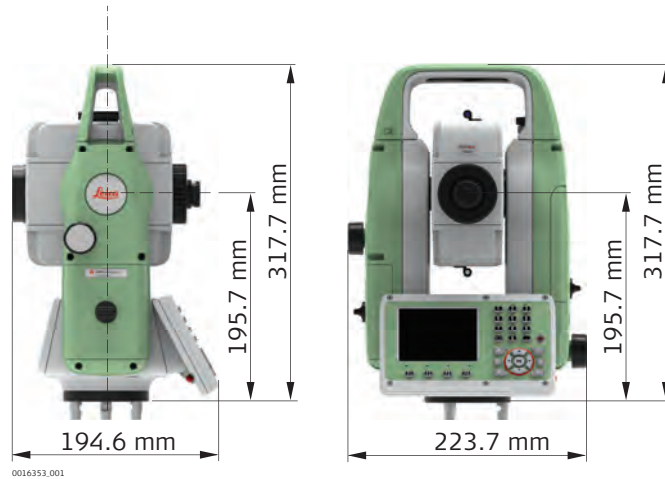

TS07

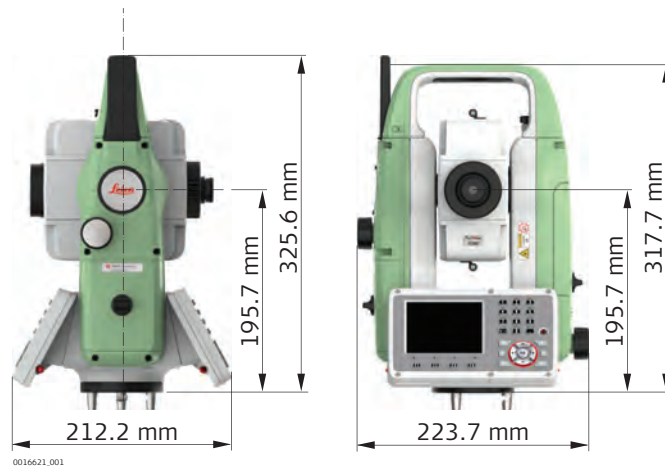

Weight

Type	Value
Instrument	4.3 kg - 4.5 kg (depending on hardware configuration)
Tribrach	760 g
Battery GEB331	110 g
Battery GEB361	340 g

Tilting axis height

Type	Description
Without tribrach	196 mm
With tribrach (GDF111)	240 mm

Recording

Model	Memory Type	Capacity [MB]	Number of measurements
TS03	Internal memory	800	90,000
TS07	Internal memory	800	90,000

Laser plummet

Type	Description
Type	Visible red laser class 2
Location	In standing axis of instrument
Accuracy	Deviation from plumb line 1.5 mm at 1.5 m instrument height
Diameter of laser point	2.5 mm at 1.5 m instrument height

AutoHeight plummet

Type	Description
Type	Visible red laser class 2
Location	In standing axis of instrument
Centering accuracy	Deviation from plumb line: 1.5 mm at 1.5 m instrument height
Diameter of laser point	2.5 mm at 1.5 m instrument height
Height accuracy ^{1,2}	1.0 mm
Measurement range ³	0.7 m to 2.7 m
Measurement time, typically	< 3 s

1 Standard deviation (1 sigma) over measurement range

2 Object in shade, sky overcast, Kodak Grey Card (18% reflective), balanced tribrach foot screws

3 Instrument height from tilting axis

 Avoid dirt on cover glass.

 Avoid line-of-sight obstructions. The full spot needs to be on target.

 For best performance use the new Leica tripods. For older tripods, an upgrade of the screw is recommended.

Power

Type	Description
External supply voltage (via serial interface)	Nominal voltage 13.0 V DC Range 12.0 V - 15.0 V

Internal battery

Type	Battery	Voltage	Capacity	Operating time, typically*
GEB331	Li-Ion	11.1 V	2.8 Ah	≤ 15 h
GEB361	Li-Ion	11.1 V	5.6 Ah	≤ 30 h

* Based on a single measurement every 30 s at 25°C. Operating time may be shorter if battery is not new.

Environmental specifications

Temperature

Type	Operating temperature [°C]	Storage temperature [°C]
All instruments	-20 to +50	-40 to +70
Battery	-20 to +50	-40 to +70
USB memory stick	-40 to +85	-50 to +95

Protection against water, dust and sand

Type	Protection
All instruments	IP66 (IEC 60529)

Humidity

Type	Protection
All instruments	Max 95% non condensing. The effects of condensation are to be effectively counteracted by periodically drying out the instrument.

Arctic model

Operating temperature [°C]	Storage temperature [°C]
-35 to +50	-40 to +70

Electronic Guide Light EGL

Type	Description
Working range	5 m to 150 m (15 ft to 500 ft)
Position accuracy	5 cm at 100 m (1.97" at 330 ft)

Automatic corrections

The following automatic corrections are made:

- Line of sight error
- Tilting axis error
- Earth curvature
- Standing axis tilt
- Vertical index error
- Refraction
- Compensator index error
- Circle eccentricity

16.7

Scale Correction

Use of scale correction

By entering a scale correction, reductions proportional to distance can be taken into account.

- Atmospheric correction.
- Reduction to mean sea level.
- Projection distortion.

Atmospheric correction

The slope distance displayed is correct if the scale correction in ppm, mm/km, which has been entered corresponds to the atmospheric conditions prevailing at the time of the measurement.

The atmospheric correction includes:

- Adjustments for air pressure
- Air temperature

For highest precision distance measurements, the atmospheric correction should be determined with:

- An accuracy of 1ppm
- Air temperature to 1°C
- Air pressure to 3mbar

Atmospheric corrections °C

Atmospheric corrections in ppm with temperature [°C], air pressure [mb] and height [m] at 60% relative humidity.

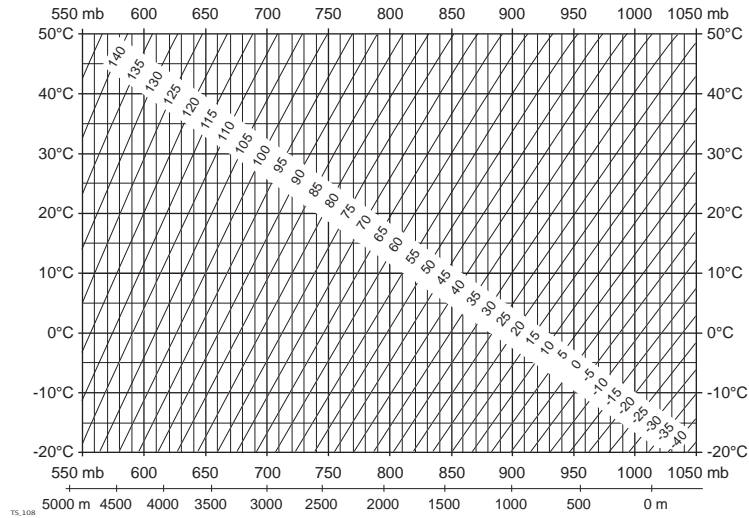

Atmospheric corrections °F

Atmospheric corrections in ppm with temperature [°F], air pressure [inch Hg] and height [ft] at 60% relative humidity.

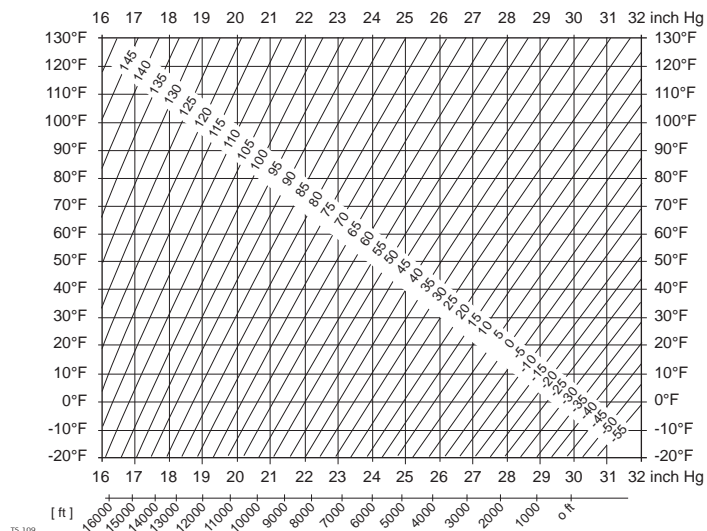

16.8

Reduction Formulas

Reflector types

The reduction formulas are valid for measurements to all reflector types:

- To prisms
- To reflector tape
- Reflectorless measurements

Slope distance - corrections

Available formats depend on the instrument.

Format	Description
<ul style="list-style-type: none"> • Instrument display • DBX • ASCII • GSI 	<ul style="list-style-type: none"> • Corrections for the atmospheric ppm are applied to the slope distances according to the formulas.
<ul style="list-style-type: none"> • XML export 	<ul style="list-style-type: none"> • Output without corrections for the atmospheric ppm • ppm is stored as metadata • Corrections are applied during later input, for example to Leica Infinity

Formulas

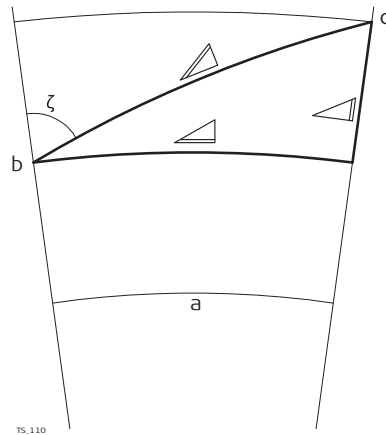

- a Mean Sea Level
- b Instrument
- c Reflector
- ▴ Slope distance
- ▴ Horizontal distance
- ▴ Height difference

The instrument calculates the slope distance, horizontal distance, height difference in accordance with the following formulas:

$$\triangle = D_0 \cdot (1 + \text{ppm} \cdot 10^{-6}) + AC$$

002425_002

- ▴ Displayed slope distance [m]
- D_0 Uncorrected distance [m]
- ppm Atmospheric scale correction [mm/km]
- AC Additive constant of the reflector [m]

$$\sphericalangle = Y - A \cdot X \cdot Y$$

TS, 112

$$\sphericalangle = X + B \cdot Y^2$$

TS, 113

\sphericalangle	Horizontal distance [m]
\sphericalangle	Height difference [m]
Y	$\sphericalangle \cdot \sin\zeta $
X	$\sphericalangle \cdot \cos\zeta$
ζ	Vertical circle reading
A	$(1 - k / 2) / R = 1.47 \cdot 10^{-7} \text{ [m}^{-1}\text{]}$
B	$(1 - k) / (2 \cdot R) = 6.83 \cdot 10^{-8} \text{ [m}^{-1}\text{]}$
k	0.13 (mean refraction coefficient)
R	$6.378 \cdot 10^6 \text{ m}$ (radius of the earth)

Earth curvature (1/R) and mean refraction coefficient (k) are automatically taken into account when calculating the horizontal distance and height difference. The calculated horizontal distance relates to the station height and not to the reflector height.

Software Licence Agreement

This product contains software that is preinstalled on the product, or that is supplied to you on a data carrier medium, or that can be downloaded by you online according to prior authorisation from Leica Geosystems. Such software is protected by copyright and other laws and its use is defined and regulated by the Leica Geosystems Software Licence Agreement, which covers aspects such as, but not limited to, Scope of the Licence, Warranty, Intellectual Property Rights, Limitation of Liability, Exclusion of other Assurances, Governing Law and Place of Jurisdiction. Please make sure, that at any time you fully comply with the terms and conditions of the Leica Geosystems Software Licence Agreement.

Such agreement is provided together with all products and can also be referred to and downloaded at the Leica Geosystems home page at <http://leica-geosystems.com/about-us/compliance-standards/legal-documents> or collected from your Leica Geosystems distributor.

You must not install or use the software unless you have read and accepted the terms and conditions of the Leica Geosystems Software Licence Agreement. Installation or use of the software or any part thereof, is deemed to be an acceptance of all the terms and conditions of such Licence Agreement. If you do not agree to all or some of the terms of such Licence Agreement, you must not download, install or use the software and you must return the unused software together with its accompanying documentation and the purchase receipt to the distributor from whom you purchased the product within ten (10) days of purchase to obtain a full refund of the purchase price.



Depending on local firmware versions the menu items may differ.

Menu tree

- |-- Setup
- |-- Survey
- |-- Setout
- |-- Apps
 - | |-- Stn.Setup
 - | |-- Survey
 - | |-- Setout
 - | |-- Tie Dist.
 - | |-- COGO
 - | |-- Area&Vol.
 - | |-- Remote Ht
 - | |-- Traverse
 - | |-- Ref.Line
 - | |-- Ref.Arc
 - | |-- Ref.Plane
 - | |-- Road 2D
 - | |-- Road 3D
 - | |-- Tunnel
- |-- Settings
 - | |-- Work
 - | |-- Regional
 - | |-- Data
 - | |-- Screen...
 - | |-- EDM
 - | |-- Interface
 - | |-- Internet
 - | |-- FTP
 - | |-- Adjust
 - | |-- Startup
 - | |-- Info
 - | |-- Licence
 - | |-- PIN
 - | |-- Load FW
- |-- New Job
- |-- Manage
 - | |-- Job
 - | |-- Fixpoints
 - | |-- Meas.Data
 - | |-- Data Transfer
 - | |-- Del.Data
 - | |-- USB-stick
 - | |-- SD card
 - | |-- Int. Memory
 - | |-- Codes
 - | |-- Formats
 - | |-- ScrShots

Appendix B

Directory Structure

Description

On the USB memory stick, files are stored in certain directories. The following diagram is the default directory structure.

Directory structure

-- APPLICATION DATA	• Alignment files (*.db)
-- CODES	• Codelists (*.cls)
-- DB	
-- JOB FOLDER	• Databases (*.db)
-- IMAGES	• Image files (*.bmp), stored in a subfolder per job.
-- DOWNLOAD	
-- FORMATS	• Format files (*.fmt)
-- GPS	
-- IMAGES	
-- JOBS	• GSI, DXF, ASCII and LandXML files (*.*)
	• Logfiles created from apps
-- LICENSE	• Licence file (*.key)
-- SYSTEM	• Log files (ErrorLog_*.txt and Loader-Log_*.txt)
	• ThreadId.txt
	• Firmware files (FlexField.fw and Flex-Field_EDM.fw)
	• Configuration files (*.cfg)
-- SYSLANG	• Language files (xx_Lang-xx.ui)

849684-1.0.0en

Original text (849684-1.0.0en)

Published in Switzerland

© 2018 Leica Geosystems AG, Heerbrugg, Switzerland

Leica Geosystems AG

Heinrich-Wild-Strasse
CH-9435 Heerbrugg
Switzerland
Phone +41 71 727 31 31

www.leica-geosystems.com



- when it has to be **right**

Leica
Geosystems