

Leica DSX



User Manual
Version 1.1
English

- when it has to be **right**

Leica
Geosystems

Introduction

Purchase

Congratulations on the purchase of the Leica DSX.



This manual contains important safety directions as well as instructions for setting up the product and operating it. Refer to "1 Safety Directions" for further information.

Read carefully through the User Manual before you switch on the product.

Product identification

The model and serial number of your product are indicated on the type plate. Always refer to this information when you need to contact your agency or Leica Geosystems authorised service centre.

Trademarks

- Windows is a registered trademark of Microsoft Corporation in the United States and other countries
- Google is a registered trademark of Google Inc.



All other trademarks are the property of their respective owners.

Validity of this manual

This manual applies to the DSX utility detection system.

Differences between the versions are marked and described.

Available documentation

Name	Description/Format		
DSX User Manual	To operate the system to a basic level all instructions required, are included in the User Manual. Provides an overview of the system together with technical data and safety directions.	-	✓
DSX Quick Guide	Short introduction for setting up the DSX.	✓	✓

Refer to the following resources for all DSX documentation/software:

- the Leica USB stick
- <https://myworld.leica-geosystems.com>

Leica Geosystems address book

On the last page of this manual, you can find the address of Leica Geosystems headquarters. For a list of regional contacts, please visit http://leica-geosystems.com/contact-us/sales_support.



myWorld@Leica Geosystems (<https://myworld.leica-geosystems.com>) offers a wide range of services, information and training material.

With direct access to myWorld, you are able to access all relevant services whenever it is convenient for you.

Service	Description
myProducts	Add all products that you and your company own and explore your world of Leica Geosystems: View detailed information on your products and update your products with the latest software and keep up-to-date with the latest documentation.
myService	View the current service status and full service history of your products in Leica Geosystems service centres. Access detailed information on the services performed and download your latest calibration certificates and service reports.
mySupport	Create new support requests for your products that will be answered by your local Leica Geosystems Support Team. View the complete history of your support requests and view detailed information on each request in case you want to refer to previous support requests.
myTraining	Enhance your product knowledge with Leica Geosystems Campus - Information, Knowledge, Training. Study the latest online training material on your products and register for seminars or courses in your country.
myTrustedServices	Add your subscriptions and manage users for Leica Geosystems Trusted Services, the secure software services, that assist you to optimise your workflow and increase your efficiency.

Table of Contents

1	Safety Directions	5
1.1	General	5
1.2	Definition of Use	6
1.3	Limits of Use	6
1.4	Responsibilities	6
1.5	Hazards of Use	7
1.6	Electromagnetic Compatibility (EMC)	11
1.7	FCC Statement, Applicable in U.S.	13
1.8	Requirements of RSS-220 for Ground Antennas (EN/FR), Applicable in Canada	15
2	Description of the System	16
2.1	General	16
2.2	System Components	16
2.3	Delivery Contents	16
2.4	DSX Components	17
2.5	Accessories	18
2.6	General Battery Handling	18
2.7	Requirements for Using a GNSS Antenna with the DSX	19
3	Setup	20
3.1	Unfolding and Adjusting the Handle	20
3.2	Attaching and Connecting the Laptop or Tablet	20
3.3	Inserting the Battery	21
3.4	Mounting the Pole Support (Surveyor Kit Only)	22
3.5	Switching the DSX ON/OFF	22
3.6	Calibrating the Encoders	23
4	DXplore Software	24
4.1	Software Installation	24
4.2	Home Screen	24
4.3	Data Acquisition	27
4.4	Data Processing	30
5	Planning a Survey	34
6	Procedures for Working with the DSX	35
6.1	Preparing an Acquisition	35
6.2	Mapping Utilities without Using a GNSS Antenna	35
6.3	Mapping Utilities Using a GNSS Antenna	40
7	Care and Transport	52
7.1	Transport	52
7.2	Storage	52
7.3	Cleaning and Drying	52
8	Technical Data	54
8.1	General	54
8.2	Conformity to European Regulations	55
9	Software Licence Agreement	56

1 Safety Directions

1.1 General

Description

The following directions enable the person responsible for the product, and the person who actually uses the equipment, to anticipate and avoid operational hazards.

The person responsible for the product must ensure that all users understand these directions and adhere to them.

About warning messages





Warning messages are an essential part of the safety concept of the instrument. They appear wherever hazards or hazardous situations can occur.

Warning messages...

- make the user alert about direct and indirect hazards concerning the use of the product.
- contain general rules of behaviour.

For the users' safety, all safety instructions and safety messages shall be strictly observed and followed! Therefore, the manual must always be available to all persons performing any tasks described here.

DANGER, WARNING, CAUTION and **NOTICE** are standardised signal words for identifying levels of hazards and risks related to personal injury and property damage. For your safety, it is important to read and fully understand the following table with the different signal words and their definitions! Supplementary safety information symbols may be placed within a warning message as well as supplementary text.

Type	Description
 DANGER	Indicates an imminently hazardous situation which, if not avoided, will result in death or serious injury.
 WARNING	Indicates a potentially hazardous situation or an unintended use which, if not avoided, could result in death or serious injury.
 CAUTION	Indicates a potentially hazardous situation or an unintended use which, if not avoided, may result in minor or moderate injury.
NOTICE	Indicates a potentially hazardous situation or an unintended use which, if not avoided, may result in appreciable material, financial and environmental damage.
	Important paragraphs which must be adhered to in practice as they enable the product to be used in a technically correct and efficient manner.

1.2

Definition of Use

Intended use

- Data communication with external appliances
- Carrying out measurement tasks using various GNSS measuring techniques
- Validating user-input utilities based on the processed data
- Detecting and mapping underground utilities - metallic and non-metallic
- Generating project documentation and 3D map of underground utilities

Reasonably foreseeable misuse

- Use of the product without instruction.
- Use outside of the intended use and limits.
- Disabling safety systems.
- Removal of hazard notices.
- Opening the product using tools, for example screwdriver, unless this is permitted for certain functions.
- Modification or conversion of the product.
- Use after misappropriation.
- Use of products with recognisable damage or defects.
- Use with accessories from other manufacturers without the prior explicit approval of Leica Geosystems.
- Inadequate safeguards at the working site.

1.3

Limits of Use

Environment

Suitable for use in an atmosphere appropriate for permanent human habitation: not suitable for use in aggressive or explosive environments.

WARNING

Working in hazardous areas, or close to electrical installations or similar situations

Life Risk.

Precautions:

- ▶ Local safety authorities and safety experts must be contacted by the person responsible for the product before working in such conditions.



The following advice is only valid for battery charger, power adapter and car adapter.

Environment

Suitable for use in dry environments only and not under adverse conditions.



1.4

Responsibilities

Manufacturer of the product

Leica Geosystems AG, CH-9435 Heerbrugg, hereinafter referred to as Leica Geosystems, is responsible for supplying the product, including the User Manual and original accessories, in a safe condition.

Person responsible for the product

The person responsible for the product has the following duties:

- To understand the safety instructions on the product and the instructions in the User Manual.
- To ensure that it is used in accordance with the instructions.
- To be familiar with local regulations relating to safety and accident prevention.
- To inform Leica Geosystems immediately if the product and the application becomes unsafe.
- To ensure that the national laws, regulations and conditions for the operation of the product are respected.

1.5

Exposure to Radio Frequency (RF) Signals

Hazards of Use

The product is normally operated at least 1 m away from the user. At a distance of at least 1 m or greater, the typical power density level is below $1 \mu\text{W}/\text{cm}^2$ ($0.01 \text{ W}/\text{m}^2$). This value is far below the level specified by the current regulations.



When operated in the normal manner of intended use, this product does not pose health or safety risks regarding radio frequency signals.



To ensure that the radio modem is not operated without the permission of the local authorities on frequencies and/or output power levels other than those specifically reserved and intended for use without a specific permit, the internal and external radio modems have been designed to operate on frequency ranges and output power ranges. The exact use of the frequency ranges differs from one region and/or country to another.

DANGER

Risk of electrocution

Because of the risk of electrocution, it is dangerous to use poles, levelling staffs and extensions in the vicinity of electrical installations such as power cables or electrical railways.

Precautions:

- ▶ Keep at a safe distance from electrical installations. If it is essential to work in this environment, first contact the safety authorities responsible for the electrical installations and follow their instructions.



WARNING

Lightning strike

If the product is used with accessories, for example masts, staffs, poles, you may increase the risk of being struck by lightning.

Precautions:

- ▶ Do not use the product in a thunderstorm.

WARNING

Folding the handle

Risk of crushing hands and fingers.



Precautions:

- ▶ Keep hands and fingers clear from crossing parts when folding handle to avoid crushing.

WARNING

Inadequate securing of the working site

This can lead to dangerous situations, for example in traffic, on building sites and at industrial installations.

Precautions:

- ▶ Always ensure that the working site is adequately secured.
- ▶ Adhere to the regulations governing safety, accident prevention and road traffic.

WARNING

Distraction/loss of attention

During dynamic applications, for example stakeout procedures, there is a danger of accidents occurring if the user does not pay attention to the environmental conditions around, for example obstacles, excavations or traffic.

Precautions:

- ▶ The person responsible for the product must make all users fully aware of the existing dangers.

WARNING

Unauthorised opening of the product

Either of the following actions may cause you to receive an electric shock:

- Touching live components
- Using the product after incorrect attempts were made to carry out repairs

Precautions:

- ▶ Do not open the product!
- ▶ Only Leica Geosystems authorised service centres are entitled to repair these products.

For the AC/DC power supply and the battery charger:

WARNING

Electric shock due to use under wet and severe conditions

If unit becomes wet it may cause you to receive an electric shock.

Precautions:

- ▶ If the product becomes humid, it must not be used!
- ▶ Use the product only in dry environments, for example in buildings or vehicles.



- ▶ Protect the product against humidity.

For the AC/DC power supply and the battery charger:

WARNING

Unauthorised opening of the product

Either of the following actions may cause you to receive an electric shock:

- Touching live components
- Using the product after incorrect attempts were made to carry out repairs.

Precautions:

- ▶ Do not open the product!
- ▶ Only Leica Geosystems authorised service centres are entitled to repair these products.

WARNING

Inappropriate mechanical influences to batteries

During the transport, shipping or disposal of batteries it is possible for inappropriate mechanical influences to constitute a fire hazard.

Precautions:

- ▶ Before shipping the product or disposing it, discharge the batteries by the product until they are flat.
- ▶ When transporting or shipping batteries, the person in charge of the product must ensure that the applicable national and international rules and regulations are observed.
- ▶ Before transportation or shipping, contact your local passenger or freight transport company.

WARNING

Exposure of batteries to high mechanical stress, high ambient temperatures or immersion into fluids

This can cause leakage, fire or explosion of the batteries.

Precautions:

- ▶ Protect the batteries from mechanical influences and high ambient temperatures. Do not drop or immerse batteries into fluids.

⚠️ WARNING

Short circuit of battery terminals

If battery terminals are short circuited e.g. by coming in contact with jewellery, keys, metallised paper or other metals, the battery can overheat and cause injury or fire, for example by storing or transporting in pockets.

Precautions:

- ▶ Make sure that the battery terminals do not come into contact with metallic objects.

⚠️ WARNING

Short circuit of battery

Risk of fire, electric shock and damage.

Precautions:

- ▶ Do not open the battery housing.
- ▶ Keep away any metallic or wet objects from the battery connectors.

⚠️ WARNING

Battery may get hot after prolonged use.

Risk of burning injuries.

Precautions:

- ▶ Avoid touching the hot battery.
- ▶ Allow the battery to cool down before removing it.

⚠️ WARNING

Improper disposal

If the product is improperly disposed of, the following can happen:

- If polymer parts are burnt, poisonous gases are produced which may impair health.
- If batteries are damaged or are heated strongly, they can explode and cause poisoning, burning, corrosion or environmental contamination.
- By disposing of the product irresponsibly you may enable unauthorised persons to use it in contravention of the regulations, exposing themselves and third parties to the risk of severe injury and rendering the environment liable to contamination.

Precautions:

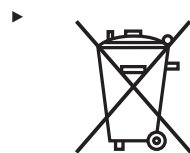

The product must not be disposed with household waste. Dispose of the product appropriately in accordance with the national regulations in force in your country. Always prevent access to the product by unauthorised personnel.

Product-specific treatment and waste management information can be received from your Leica Geosystems distributor.

WARNING

Improperly repaired equipment

Risk of injuries to users and equipment destruction due to lack of repair knowledge.

Precautions:

- ▶ Only authorised Leica Geosystems Service Centres are entitled to repair these products.

CAUTION

Not properly secured accessories

If the accessories used with the product are not properly secured and the product is subjected to mechanical shock, for example blows or falling, the product may be damaged or people can sustain injury.

Precautions:

- ▶ When setting up the product, make sure that the accessories are correctly adapted, fitted, secured, and locked in position.
- ▶ Avoid subjecting the product to mechanical stress.

CAUTION

Before any cleaning procedure, ensure that the instrument is switched off and the battery has been removed.

CAUTION

Unused connectors must be protected using the attached dust cap.

NOTICE

Dropping, misusing, modifying, storing the product for long periods or transporting the product

Watch out for erroneous measurement results.

Precautions:

- ▶ Periodically carry out test measurements and perform the field adjustments indicated in the User Manual, particularly after the product has been subjected to abnormal use as well as before and after important measurements.

1.6

Electromagnetic Compatibility (EMC)

Description

The term Electromagnetic Compatibility is taken to mean the capability of the product to function smoothly in an environment where electromagnetic radiation and electrostatic discharges are present, and without causing electromagnetic disturbances to other equipment.

 **WARNING**

Electromagnetic radiation

Electromagnetic radiation can cause disturbances in other equipment.

Precautions:

- ▶ Although the product meets the strict regulations and standards which are in force in this respect, Leica Geosystems cannot completely exclude the possibility that other equipment may be disturbed.

 **WARNING**

Use of product with radio or digital cellular phone devices

Electromagnetic fields can cause disturbances in other equipment, in installations, in medical devices, for example pacemakers or hearing aids and in aircrafts. Electromagnetic fields can also affect humans and animals.

Precautions:

- ▶ Although the product meets the strict regulations and standards which are in force in this respect, Leica Geosystems cannot completely exclude the possibility that other equipment can be disturbed or that humans or animals can be affected.
- ▶ Do not operate the product with radio or digital cellular phone devices in the vicinity of filling stations or chemical installations, or in other areas where an explosion hazard exists.
- ▶ Do not operate the product with radio or digital cellular phone devices near to medical equipment.
- ▶ Do not operate the product with radio or digital cellular phone devices in aircrafts.
- ▶ Do not operate the product with radio or digital cellular phone devices for long periods with the product immediately next to your body.

 **CAUTION**

Use of the product with accessories from other manufacturers. For example field computers, personal computers or other electronic equipment, non-standard cables or external batteries

This may cause disturbances in other equipment.

Precautions:

- ▶ Use only the equipment and accessories recommended by Leica Geosystems.
- ▶ When combined with the product, they meet the strict requirements stipulated by the guidelines and standards.
- ▶ When using computers, two-way radios or other electronic equipment, pay attention to the information about electromagnetic compatibility provided by the manufacturer.

CAUTION

Intense electromagnetic radiation. For example, near radio transmitters, transponders, two-way radios or diesel generators

Although the product meets the strict regulations and standards which are in force in this respect, Leica Geosystems cannot completely exclude the possibility that function of the product may be disturbed in such an electromagnetic environment.

Precautions:

- ▶ Check the plausibility of results obtained under these conditions.

CAUTION

Electromagnetic radiation due to improper connection of cables

If the product is operated with connecting cables attached at only one of their two ends, for example external supply cables, interface cables, the permitted level of electromagnetic radiation may be exceeded and the correct functioning of other products may be impaired.

Precautions:

- ▶ While the product is in use, connecting cables, for example product to external battery, product to computer, must be connected at both ends.

1.7

FCC Statement, Applicable in U.S.



The greyed paragraph below is only applicable for products without radio.

FCC ID: RFD-CTDSX

This device complies with part 15 of the FCC Rules.

Operation is subject to the following conditions:

- This device may not cause harmful interference.
- This device must accept any interference received, including interference that may cause undesired operation.

CAUTION

Changes or modifications

Changes or modifications to this unit not expressly approved by the party responsible for compliance could void the user's authority to operate the equipment.

- ▶ Do not change or modify this unit without approval by the party responsible for compliance!

Operation of this device is restricted to law enforcement, fire and rescue officials, scientific research institutes, commercial mining companies, and construction companies. Operation by any other party is a violation of 47 U.S.C. § 301 and could subject the operator to serious legal penalties.

Coordination Requirements:

(a) UWB imaging systems require coordination through the FCC before the equipment may be used. The operator shall comply with any constraints on equipment usage resulting from this coordination.

(b) The users of UWB imaging devices shall supply detailed operational areas to the FCC Office of Engineering and Technology who shall coordinate this

information with the Federal Government through the National Telecommunications and Information Administration. The information provided by the UWB operator shall include the name, address and other pertinent contact information of the user, the desired geographical area of operation, and the FCC ID number and other nomenclature of the UWB device. This material shall be submitted to the following address:

Frequency Coordination Branch., OET
Federal Communications Commission
445 12th Street, SW
Washington, D.C. 20554
ATTN: UWB Coordination

(c) The manufacturers, or their authorized sales agents, must inform purchasers and users of their systems of the requirement to undertake detailed coordination of operational areas with the FCC prior to the equipment being operated.

(d) Users of authorized, coordinated UWB systems may transfer them to other qualified users and to different locations upon coordination of change of ownership or location to the FCC and coordination with existing authorized operations.

(e) The NTIA/FCC coordination report shall include any needed constraints that apply to day-to-day operations. Such constraints could specify prohibited areas of operations or areas located near authorized radio stations for which additional coordination is required before operation of the UWB equipment. If additional local coordination is required, a local coordination contact will be provided.

(f) The coordination of routine UWB operations shall not take longer than 15 business days from the receipt of the coordination request by NTIA. Special temporary operations may be handled with an expedited turn-around time when circumstances warrant. The operation of UWB systems in emergency situations involving the safety of life or property may occur without coordination provided a notification procedure, similar to that contained in CFR47 Section 2.405(a)-(e), is followed by the UWB equipment user.

 **CAUTION**

Changes or modifications not expressly approved by Leica Geosystems for compliance could void the user's authority to operate the equipment.

Labelling DSX

The model and serial number of DSX are indicated on the model plate which can be found in the battery compartment.



1.8

Requirements of RSS-220 for Ground Antennas (EN/FR), Applicable in Canada

IMPORTANT NOTE FOR THE CANADIAN CUSTOMERS

Canada Compliance Statement

IC Certification Number: **3177A-CTDSX**

This device complies with the requirements of IC Standard RSS-220.

This Ground Penetrating Radar Device shall be operated only when in contact with or within 1 m of the ground.

This Ground Penetrating Radar Device shall be operated only by law enforcement agencies, scientific research institutes, commercial mining companies, construction companies, and emergency rescue or firefighting organizations.

NOTE IMPORTANTE POUR LES UTILISATEURS CANADIENS

Canada Compliance Statement

Numéro de certification : **3177A-CTDSX**

Cet appareil est conforme aux exigences de la norme RSS IC-220.

Cet équipement géoradar doit être utilisé que lorsqu'il est en contact ou à moins de 1 mètre du sol.

Cet équipement géoradar doit être utilisé que par des organismes d'application de la loi, des instituts de recherche scientifique, des sociétés minières commerciales, des entreprises de construction et de secours d'urgence ou les organisations de lutte contre les incendies.

CANADIAN REPRESENTATIVE

Company Name : Leica Geosystems Ltd

CN Number : 3177B

Contact Name : Sudha Sachdeva

City : SCARBOROUGH, Ontario M1W3S2

Telephone No : +1 416 497 2463

Email : sudha.sachdeva@leicaus.com

2 Description of the System

2.1 General

Area of application The DSX utility detection system is designed to detect and locate both metallic and non-metallic underground utilities. It provides georeferenced utility maps in survey-grade accuracy when a supported positioning system is used.

2.2 System Components

DSX System The DSX system consists of the following components:



- a DSX utility detection radar
- b Tablet with DXplore software
- c GNSS antenna (optional)

2.3 Delivery Contents



The delivered components depend on the package ordered.

DSX system

The DSX system includes the following components:

- DSX utility detection radar
- CMS1000 controller mount system
- AB1000 accessory bag
- GEB242 battery
- GKL312 charger
- GEV192-9 AC/DC adaptor
- GAS1000 grid assistance square
- USB card with User Manual
- Hex keys



Configurable and region-based components such as CT1000 tablet, DXplore software, CA35 power cable, PS1000 pole support and CCPs are included in product packages.

2.4

DSX Components

DSX

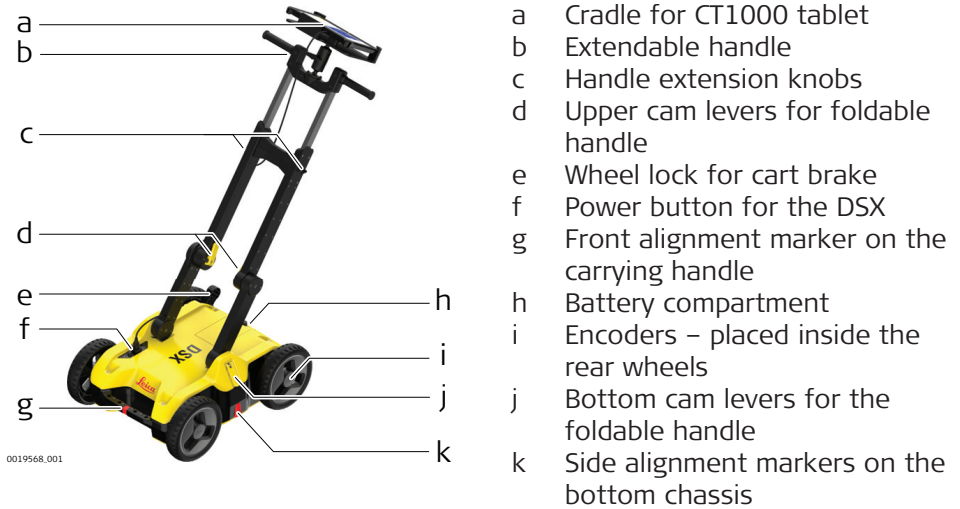

Description of the main components

Component	Description
Single-frequency antenna	The 600 MHz antenna detects underground utilities up to a depth of 2 m, depending on the soil conditions.
Control unit	The DSX communicates with the positioning systems, the tablet and the encoders to ensure the entire system is working together correctly.
Encoders	The encoders are used for measuring the distance travelled from the starting point of a scan. The measured distance is constantly transferred to the DSX. The encoders are positioned inside the rear wheels of the DSX to ensure correct measurements even in rough terrain.
Handle	The handle of the DSX can be adjusted both in height and inclination. The recommended inclination is indicated with markers on the handle. For easy transport of the DSX, the handle can be folded up. The LAN cable for connecting to the tablet is by the right handle
Wheels	DSX is using solid rubber tires which do not require pumping.
Support tablet	The support is designed to hold a Getac CT1000 tablet. The inclination of the support can be adjusted to the optimal viewing angle.
Pole support (surveyor kit only)	The pole support includes two clamps and two brackets. Both clamps will be attached to the pole and the brackets mounted to the handle and housing.

2.5

Accessories

Components inside the AB1000 accessory bag

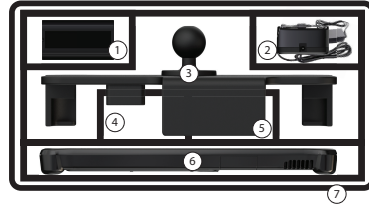

- 1 DSX battery
- 2 Charger and plug adapter
- 3 Cradle
- 4 CT1000 charger
- 5 Pole support
- 6 CT1000 tablet
- 7 Accessory bag (symbolised)

Components outside the accessories bag

GAS1000 grid assistance square is used for setting up grid for accurate data acquisition.

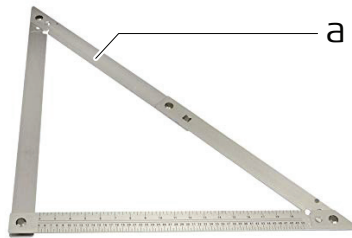

0019635_001

a GAS1000 grid assistance square

2.6

General Battery Handling



Charging

The permissible temperature range for charging is between 0 °C to +40 °C / +32 °F to +104 °F. For optimal charging, we recommend charging the batteries at a low ambient temperature of +10 °C to +20 °C / +50 °F to +68 °F if possible.

Operation/Discharging

- The batteries can be operated from -20 °C to +50 °C / -4 °F to +122 °F.
- Low operating temperatures reduce the capacity that can be drawn; high operating temperatures reduce the service life of the battery.

Storage

- Remove batteries from the product and the charger before storing.
- After storage recharge batteries before using.
- Protect batteries from damp and wetness. Wet or damp batteries must be dried before storing or use.
- The batteries can be stored from -20 °C to +50 °C / -4 °F to +122 °F.

Charging the battery



The DSX battery is removable from the battery compartment and is chargeable.



You cannot turn on the DSX while the battery compartment is empty.

1. Place the battery in the charger and use the appropriate plug head before charging.



0019588_001

-
2. *While charging, the LED of the battery charger lights up orange.
When the battery is nearly charged, the LED turns yellow.
When the battery is fully charged, the LED turns green.*
-

2.7

Requirements for Using a GNSS Antenna with the DSX

Requirements

The DSX can be used with a GNSS antenna to position the radar-scanning data in an absolute coordinates system and to receive real-time positional corrections while the DSX cart is moving and collecting data.

The antenna should fulfill the following requirements:

- Multi-frequency (L1 + L2 + L5)
- Positioning update greater than 5 Hz
- Bluetooth
- RTK (Real-Time Kinematic) reference station functionality
- RTK network
- Unlimited RTK range
- DGPS/RTCM



Refer to the equipment list for compatible models.

For the best result achieved, we recommend using a GS18 T antenna with tilt compensation.

3

Setup

Procedure for setting up the DSX

The setup procedure of the DSX consists of the following steps:

- Unfolding and adjusting the handle (refer to "3.1 Unfolding and Adjusting the Handle")
- Inserting the battery (refer to "3.3 Inserting the Battery")
- Attaching and connecting the CT1000 tablet (refer to "3.2 Attaching and Connecting the Laptop or Tablet")
- Mounting the pole support (optional; refer to "3.4 Mounting the Pole Support (Surveyor Kit Only)")
- Calibrating the encoders (refer to "3.6 Calibrating the Encoders")

3.1

Unfolding and Adjusting the Handle

Unfold and adjust the handle

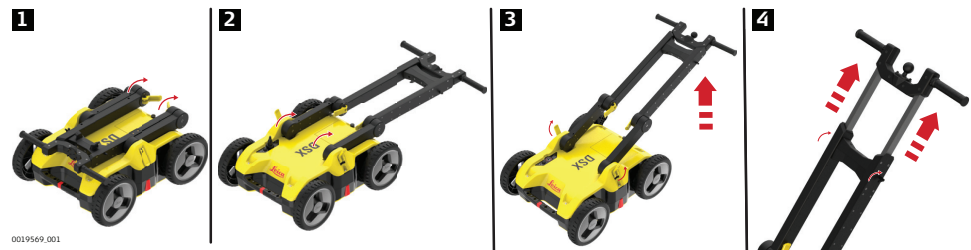

1. Release inner cam levers and unfold upper handle legs .
2. Lock inner cam levers until the visual markers are aligned.
3. Release outer cam levers and raise entire handle assembly until the visual markers are aligned.
4. Loosen the knobs to extend the upper handles, and then tighten them.

3.2

Attaching and Connecting the Laptop or Tablet

Attach and connect the tablet

 The support is designed to hold a CT1000 tablet.



 The support includes the tablet cradle to hold the tablet, two RAM balls (one attached to the cart handles and the other to the cradle). Also it includes a double socket arm which holds together the RAM balls.



0019587_001

1. Mount the two RAM balls to attach the tablet to the handle:
 - One to the handle top
 - The other to the tablet cradle
2. Use the double socket arm to hold the two RAM balls: Adjust the tablet cradle until optimal inclination and then tighten the screw on the double socket arm.

3. Plug in the DSX LAN cable to the tablet.



0019637_001

3.3

Inserting the Battery

Insert the battery

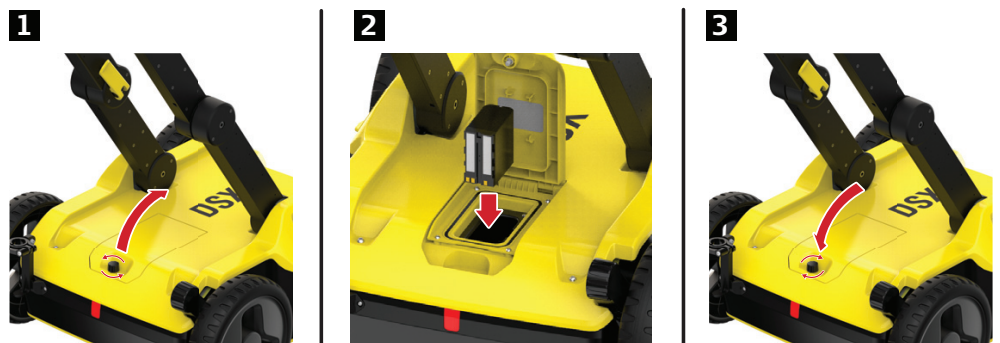

0019570_002

1. To open the battery compartment, loosen the screw on the battery compartment.

2. Insert the battery facing downwards. The rough surface of the battery points towards the up-down direction.
3. Close the battery compartment and tighten the screw.

3.4

Mounting the Pole Support (Surveyor Kit Only)

Step-by-step



1. Mount the two brackets:
 - One to the left handle
 - The other to the upper chassis
2. Attach the two clamps to the pole.
3. Make sure the clamps align, so they can both fit into the brackets. Tighten the screws of the clamps, so they are stable on the pole.
4. Place the lower clamp in the housing bracket, and then fit the upper clamp in the handle bracket.
5. Tighten the screw of the handle bracket.

3.5

Switching the DSX ON/OFF

Switch the DSX device ON/OFF



1. Press the ON/OFF key on the DSX.

3.6

Calibrating the Encoders

Calibration procedure



Calibration of the wheel encoder when using the DSX for the first time is mandatory.

We recommend, to calibrate the wheel encoders at least once on each scan site. In particular when ground conditions change - for example, from asphalt to grass.

1. Measure out a distance of exact 10 m. The defined distance is used as a reference for the calibration procedure.
-



Ensure that the tablet is connected to the DSX.

2. Turn on the DSX. Turn on the tablet and start the DXplore software.
 3. Start the calibration procedure with the DXplore software. Refer to "Wheel encoder calibration".
 4. Move the DSX along the defined distance.
 5. Complete the calibration procedure with the DXplore software and check the calibration result. If necessary, repeat the calibration.
-



After the prominent part on the outer wheel is worn out, it is required to perform an encoder calibration. Lift one wheel during the calibration procedure for a separate encoder calibration. Then repeat the procedure with the other wheel. Compare the results with the defined distance to ensure that both encoders work properly.

4 DXplore Software

4.1 Software Installation

Requirements for installing the DXplore software

When purchasing a DSX package that includes a CT1000 tablet, the **DXplore** software is already installed on the tablet.

DXplore software can be downloaded from myWorld.



Before running the software make sure to activate software license key (entitlement ID) in CLM program. DXplore will not run without a valid software license key.

4.2 Home Screen

Home screen

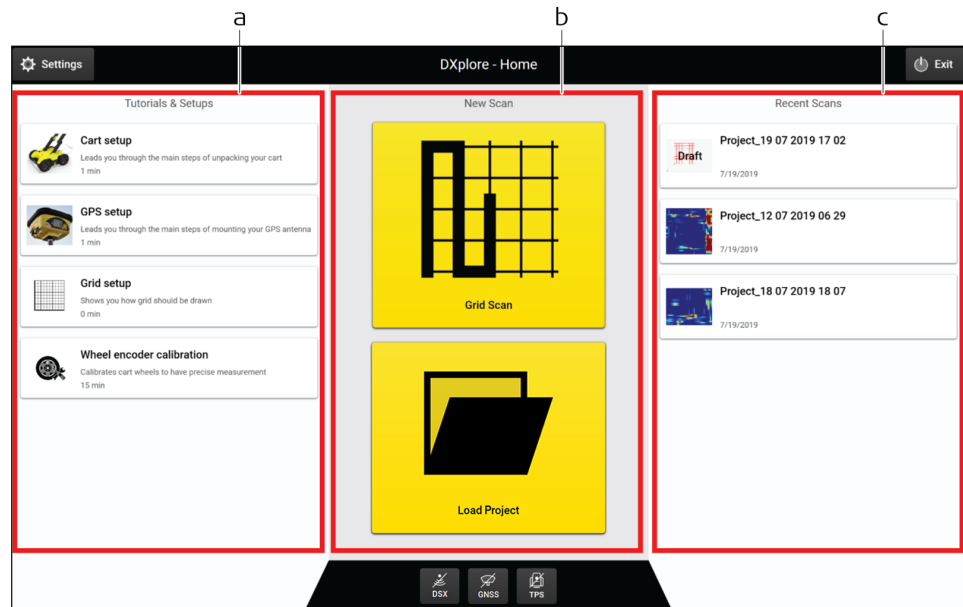





- a Left column
- b Centre column
- c Right column

Columns

Left Column

Setup tutorials include animations to instruct the user:

- Cart setup
 - Release inner cam levers
 - Unfold upper handle legs until the visual markers are aligned
 - Lock inner cam levers
 - Release outer cam levers
 - Raise entire handle assembly until the visual markers are aligned
 - (optional) Loosen the knobs and extend the upper handles, then tighten them
 - Mounted the cradles and attach the tablet
 - Connect the LAN cable to the tablet
 - Turn on the DSX radar
- GNSS setup
 - Mount the bottom bracket to the top chassis
 - Mount the upper bracket to the handle
 - Make sure the visual markers on the handles are all aligned
 - Check the direction of the upper clamp and put it through the pole
 - Put on the bottom clamp
 - Attach the bottom clamp to the bracket and then the upper one
 - Tighten the screw
- Grid marking
 - Extend the folding square until the hard stop
 - Place the folding square at the corner of your survey area and draw a right angle
 - Mark every 50 centimeters until the full grid is marked on the surface
- Wheel encoder calibration
 - Measure a 10-meter linear distance precisely
 - Tap start  and push your DSX radar cart until reaching the exact 10-meter end
 - Make sure the red markers on the side are aligned with the end point, then tap 
 - Distance is processed
 - Tap again the  and pull the DSX radar cart until reaching the original starting point
 - Tap  and check the calibration errors

Centre Column

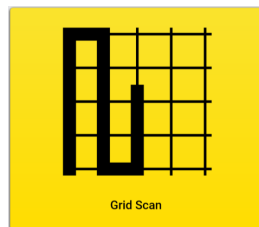

Grid Scan button:

Tap to perform a scanning task using the DSX. This button leads to the main workflow wizard until a tomography is generated.

Utilities can be exported in DXF format. Tomography in PNG, JPG, TIFF, BMP and GIF formats. Report is exported in PDF format.

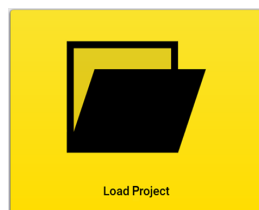

Load Project button:

Tap to open an existing project or draft that were previously processed or set up..

Right Column

In the right column view/open recent scanned projects or drafts (with all project settings saved but not yet scanned).

- Recent projects:
Tapping on those most recent scanned projects opens the processed screen by default (tomography view).
- Recent drafts:
By default the acquisition screen opens when tapping on the drafts. Start data acquisition based on the settings saved in the drafts.

Top buttons

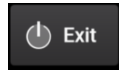

Tap to close DXplore

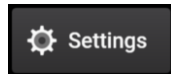

Tap to open the Settings menu

Settings menu

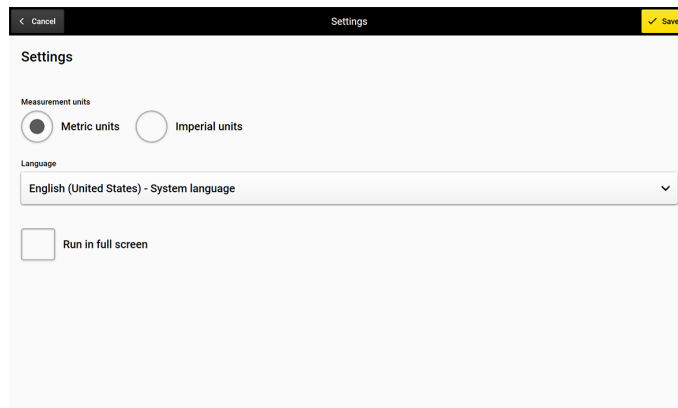

- **Measurements units:** Choose the local unit – imperial units for the US and metric units for the rest of the world.
- **Language:** Choose the required language from the drop-down list.
- **Run in full screen:** Enables you to maximise the DXplore screen when reopen DXplore next time.

Bottom buttons



Button DSX inactive



Button DSX active

Button DSX indicates the connection status to the DSX utility detection system. In active mode, the button should be green. Make sure, the button stays green throughout the entire data acquisition.



Once the DSX detection system is turned on and the CT1000 tablet gets connected to the LAN cable, this button should turn to active mode.



Button GNSS inactive

Tap on the button GNSS to set up the GNSS antenna. Currently GS18 T and GG04 plus are supported.

- Refer to "Connect the GS18 T antenna" to set up the GS18 T antenna.
- Refer to "Connect the GG04 plus antenna" to set up the GG04 plus antenna.



The GNSS antenna connection can only be done at the home screen, not during acquisition.



Button GNSS active

GNSS button indicates the connection status to the GNSS antenna.

- Make sure that the button stays green throughout the entire acquisition once a GNSS antenna is used.



Button TPS inactive

TPS is not supported yet.

4.3

Data Acquisition

Go to Acquisition

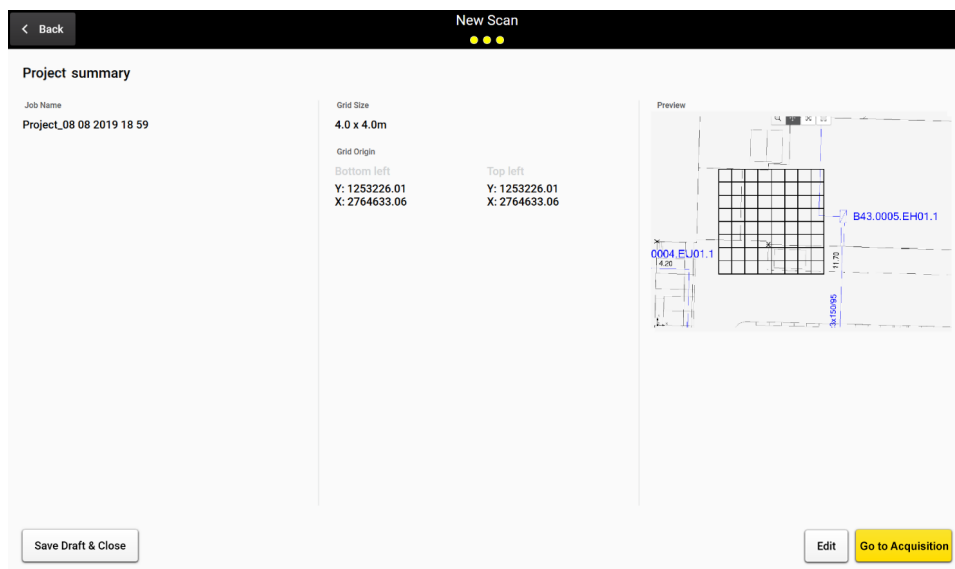

From the project summary, tap **Go to Acquisition** to get to the acquisition screen. Refer to "6 Procedures for Working with the DSX" for details.

There are two ways to get to the project summary:

- Open a draft:
Open a draft by selecting from the right column of Home screen or searching from drive with **Load Project** button. Tap **Go to Acquisition** at the bottom right.
- Set up a project from scratch:
Tap the **Grid Scan** button in the center column of Home screen --> go through project setup wizard until the project summary screen. Tap **Go to Acquisition** at the bottom right.

Acquisition screen

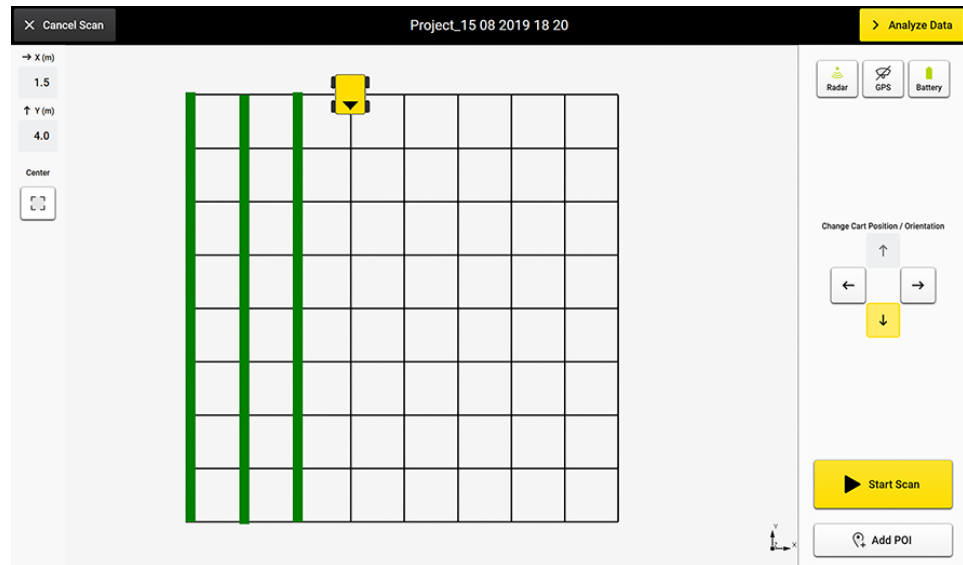

Description of the menu

→ X (m) These values indicate the cart position in the grid.

3.00

↑ Y (m)

3.10



Zoom to and center on grid.



Show/hide the layers and grid lines.



Indicates the connection status to the DSX utility detection system. This icon should be green throughout the entire acquisition. Refer to "Button DSX active" for details.



Indicates the connection status to the GNSS antenna. Refer to "Button GNSS active" for details. If a GNSS antenna is used, it should be green and not crossed-out throughout the entire acquisition.



Note, in the acquisition screen, the button only indicates the status of GNSS connection. To set up the GNSS antenna, go to the Home screen for the wizard and open the project/draft to continue the scan.



To be supported in the upcoming versions.



Indicates the battery level of the DSX utility detection system. Fully charge the battery before going out for a scan to avoid action termination due to insufficient DSX battery.



Use the arrow buttons to move the cart position and change the orientation before a scan line starts.

Acquisition

While the DSX cart is moving, the orientation or position cannot be changed. The remaining distance of the scan line is displayed.

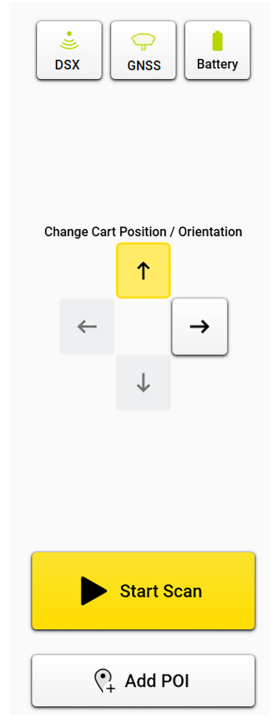

Once the cart goes beyond the end point of the scan line, the remaining distance becomes a warning.



If exceeding a certain distance and if the **Stop Scan** button is not tapped, the software forces a stop to avoid distance calculation errors.



Tap **Start Scan** button before starting a new line.



Tap **Stop Scan** once the line is completed.



Allows adding points of interest of the area while still on site. Following options are available in the current POI list:

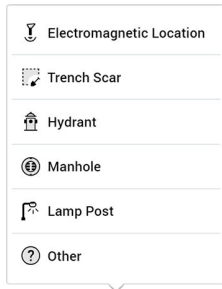

- **Electromagnetic Location** is used to mark the positions where the cable locator detects signals.
- **Trench Scar** is used to mark where the road surface has been opened and covered. This option gives ideas where utilities may be buried.
- **Hydrant** is used for giving additional information on water pipes.
- **Manhole** is used for giving additional information on water, sewer or drainage.
- **Lamp Post** is a great indication of power cables.
- **Other**: Add POIs which do not belong to the listed types.



Once the data acquisition is completed, tap **Analyse Data** to process the scan data. The result is displayed and by default in animation in the next screen.

4.4

Data Processing

Data processing screen

Tap the button **Analyse Data** on the top right of the acquisition screen to open the processing/tomography screen. This button is greyed out when data acquisition has not been completed. It turns yellow once the acquisition is completed.

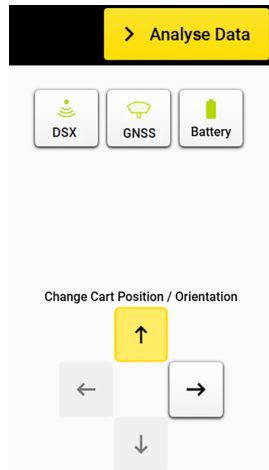

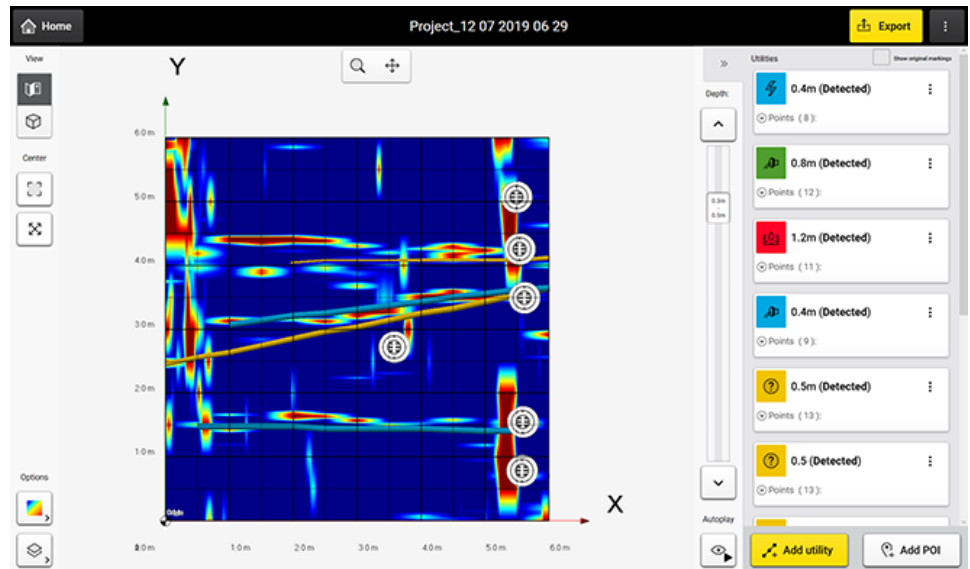

Description of the menu



Expand or collapse the right panel.

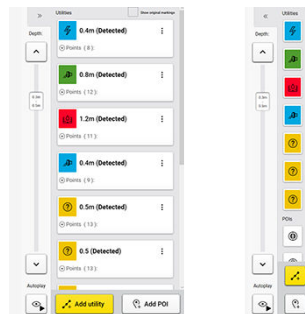

Tap to return to the **Home** screen



2D and 3D view button.

- 2D view is the top view from above and sees the entire area in a flat view.
- 3D view allows rotation to view utilities in various depths.



Zoom to and centre on grid.



Full extent to fit all added layers and the grid in the viewer.



Toggle this button for displaying the tomography in different colour schemes. This function helps identifying utilities in the tomography view.



Show/hide the layers and grid lines.



Change the depths.



It is important to review the tomography of all depth slices to find utilities in the correct depth.



Tap button to pause an automatic animation to go through all depth slices and start marking utilities.



Tap button to add the points of interest if they were not added during the acquisition. Following options are available in the current POI list:

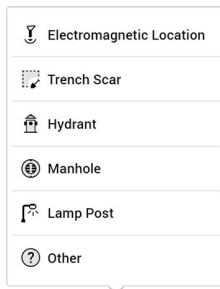

- **Electromagnetic Location** is used to mark the positions where the cable locator detects signals.
- **Trench Scar** is used to mark where the road surface has been opened and covered. This option gives ideas where utilities may be buried.
- **Hydrant** is used for giving additional information on water pipes.
- **Manhole** is used for giving additional information on water, sewer or drainage.
- **Lamp Post** is a great indication of power cables.
- **Other:** Add own POIs which do not belong to the listed types.



Tap **Add Utility** and start marking the utilities shown in each slice of the tomography view using either the pen or your finger.



Export to save your project results:

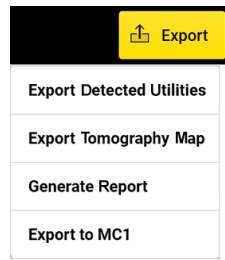

- **Export Detected Utilities:** In DXF format. Specify the export coordinate system.
- **Export Tomography Map:** In image formats. PNG, JPG, TIFF, and so on.
- **Generate Report:** Generates a survey report.
- **Export to MC1:** Generates the detected utilities and scan area in DXF format, under the MC1-compatible directory structure. This file allows using the DXplore output directly on the excavator, controlled by MC1 software by USB syncing.
- **Back to Acquisition:** Allows the operator to go back to the acquisition screen and rescan a few lines when a problem in tomography is spotted.

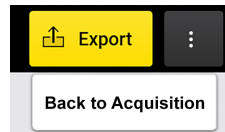

Jobsite Investigation

To carry out a survey with the DSX in the most efficient way, gather all available information before each project:

- Make yourself familiar with the jobsite features.
- Obtain technical maps, recommended in DXF format, about existing utilities on the jobsite.
- Supplement the acquired scan data by opening manholes on-site.



Be cautious when performing site investigation and make sure to adhere to local laws for safety.

Jobsite Features

The basic requirement for carrying out a survey is understanding the features of the jobsite. When gathering information about the jobsite, keep in mind the objectives of the survey. Consider the following points when preparing the survey:

- Do you need any specific permissions to carry out the survey on the jobsite, for example, access permission to pedestrian zones or permission to interrupt the traffic flow?
 - Are there any difficulties in accessing the jobsite? (Available space, any architectural features forming an obstacle, etc.).
 - Is the jobsite in an area with a high level of urban traffic, such as streets, squares or pavements? Are there parked cars that could be in the way during the survey?
-

Technical Maps of existing utilities

Technical maps of existing utilities are normally created by public utility companies. Such maps give a schematic overview about the type and position of utilities that are constructed and managed by the public utility companies. Even if these maps are generic, they can give a first impression of the existing utilities and provide additional information during the data acquisition and interpretation phase.



To obtain technical maps of the jobsite, contact the cartographic or planning office of the different utility companies. Clearly specify the streets and areas of interest. Request the maps early enough in advance to the survey, to ensure that the maps are available for the data acquisition phase.

The following list contains the most important types of utilities that need to be considered:

- Street lights
 - Low, medium and high-voltage electricity cables
 - Telephone cables
 - Gas pipes
 - Water supply pipes
 - Sewage pipes
-

Opening manholes

Once the data acquisition is complete, the opening of manholes on site can provide you with further information regarding depth, diameter and direction of the utility. This information serves as reference data during the interpretation phase.

6

Procedures for Working with the DSX

6.1

Preparing an Acquisition

Step-by-step

☞ Before departing to the jobsite, ensure that the CT1000 tablet and the DSX battery are fully charged. It is recommended to always have a second fully charge DSX battery with you as a replacement.

1. At the jobsite, set up the DSX and mount the accessories, if available. Refer to "3 Setup".

2. Pick a rectangular survey area.

☞ Each lateral has a length between 4 m/12 ft and 11 m/33 ft and is a multiple of 0.5 m/18 in. Use the grid assistance square, measuring tapes, chanks or spray to mark the survey area on the ground surface. Make sure that the corners are perpendicular and every 0.5 m/18 in on each side are clearly marked.



3. Calibrate the wheel encoders on the jobsite before proceed to scan.

☞ Measure and mark precisely a 10-meter distance. Open DXplore and tap on **Wheel Encoder Calibration** in the setup tutorial session in Home screen. Follow the wizard to complete the calibration.

4. Depending on the purpose of the survey and the available accessories, carry out one of the procedures described in the following paragraphs:

- Refer to "Mapping Utilities without Using a GNSS Antenna"
- Refer to "Mapping Utilities Using a GNSS Antenna"

6.2

Mapping Utilities without Using a GNSS Antenna

Step-by-step

Performing a scan project

This step-by-step procedure describes how to perform a scan from scratch. This chapter gives information on how to:

- Set up a project, new scan
- Perform scanning
- Check and follow-up of scans
- Export the project output

Set up a project, new scan

1. Open DXplore software.

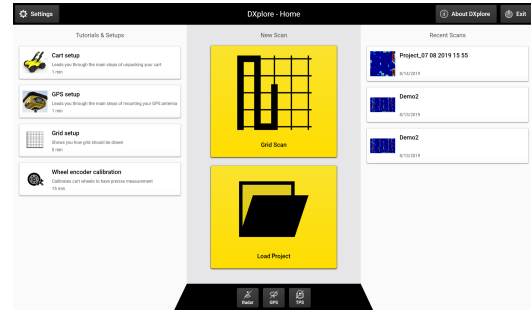

2. Start a scan.

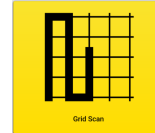

3. Enter project information.

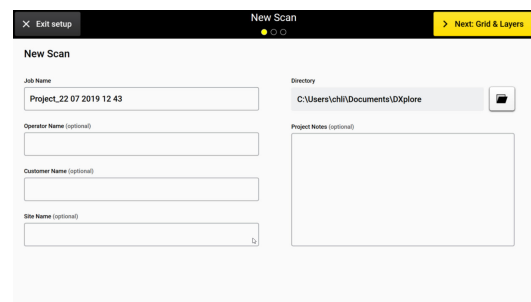

4. Define scan size and approximate location.

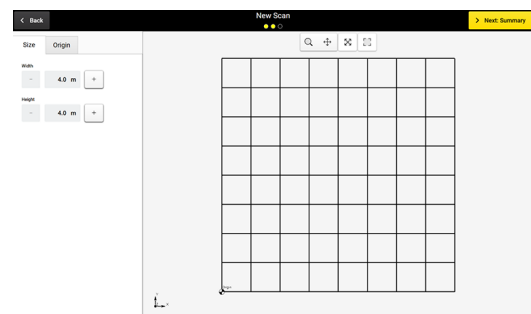

-  The grid location and orientation can only be approximated by selecting 2 points on Google Maps.

5. Tap **Search on Maps**.



6. Double-tap two points:
 - The first one to define the origin (bottom-left corner) or the scan grid.
 - The second one for the orientation.

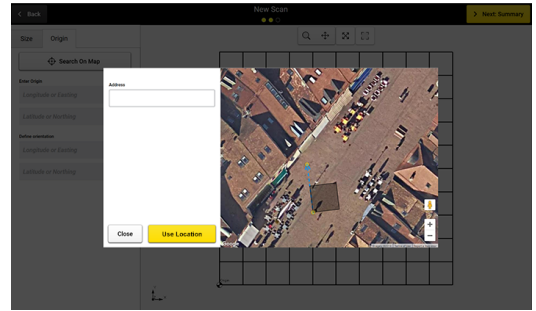

7. Tap **Use Location** to bring the location and Google Maps layer to the viewer.

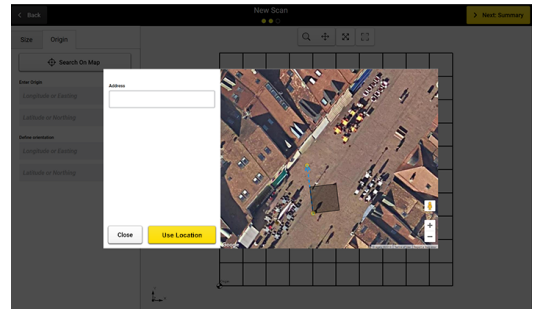

Grid origin and orientation is displayed. Zoom and pan in the viewer until reaching a preferred visualisation, then tap **Next: Summary**.

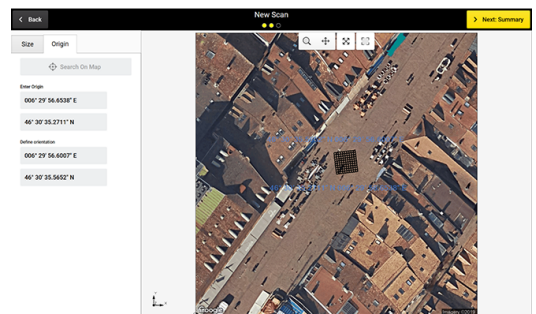

8. Confirm the information of the project summary. Save and close the draft for further scan or proceed to scanning.

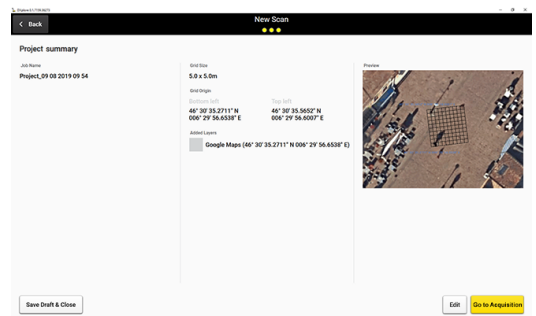

9. Make sure to have the grid physically marked on the ground surface. Refer to the setup tutorial in Home screen.

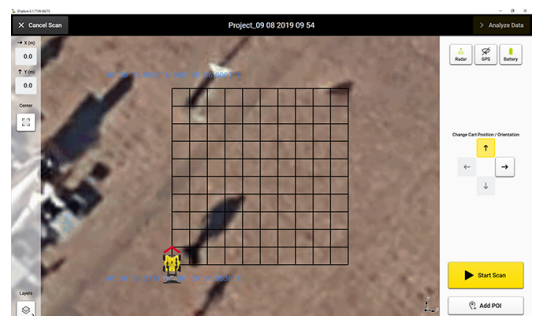

- Do a site check. Use **Add POI** to add conspicuous points of interest on site.

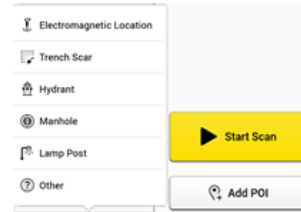

Perform scanning

- Adjust the cart position and direction using the arrows to coincide the conditions on site.

- Place the cart centre precisely on top of the starting point.

 Use the four red markers in the front, back and sides of the cart.

- Tap **Start Scan** and start pushing the cart forward.



- Precisely on top of the end point of the line tap **Stop Scan** to stop the cart.



- Once the full scan is ended, tap **Analyse Data**.



Check and follow-up of scans

 After tapping **Analyse Data** the tomography is generated. The animation is on by default.

- Tap pause button to start marking utilities.



 It is mandatory to check on each slice to find utilities in that depth range.

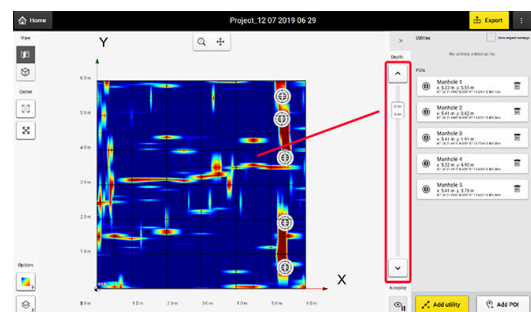

2. Tap **Add utility** and start marking the utility using your finger.



3. Mark utilities. The software starts the verification process.

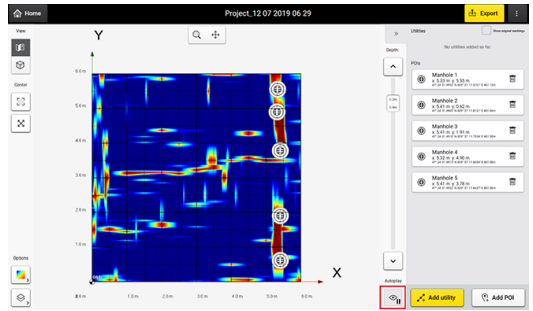

DXplore then verifies it.

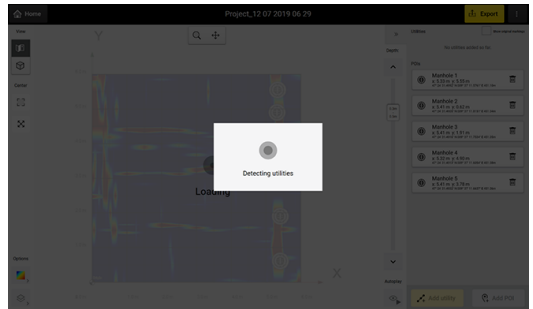

4. Utility found. If available, make sure to enter the information correctly.

Depth is estimated by the program.

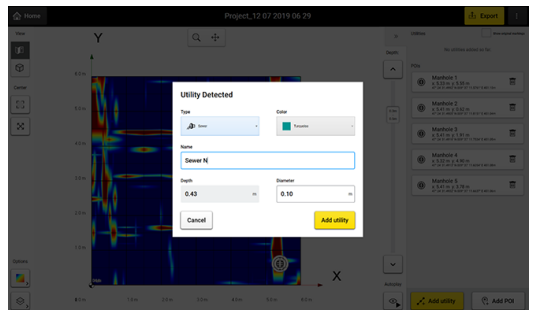

5. If the utility is not found, there is still the option to keep it as an anomaly.

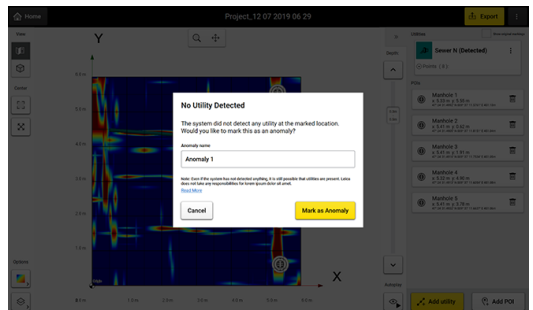

6. View your utilities in 3D.

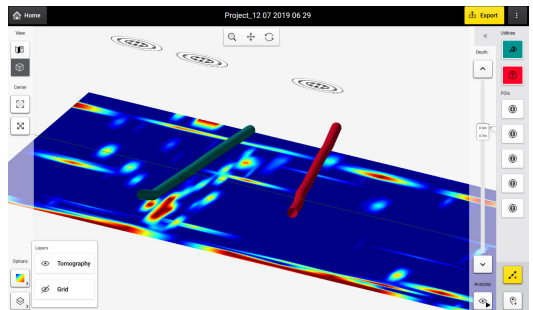

- ☞ Once all utilities are marked, continue with the export.

Export the project output

1. Make sure all utilities and POIs are marked.
2. Tap on **Export** to export the project output.



- ☞
1. Utility lines and POIs in DXF format. Output in selected Cartesian coordinate system.
 2. Current tomography in image formats.
 3. PDF report.
 4. Export to MC1: Generates the detected utilities and scan area in dxf format, under the MC1-compatible folder structure. This allows using the DXplore out-put directly on the excavator controlled by MC1 software by USB syncing.

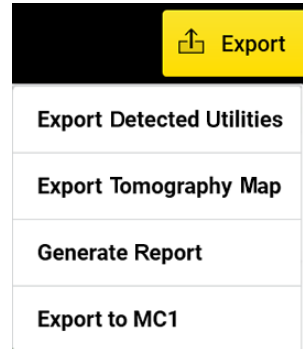

6.3

Mapping Utilities Using a GNSS Antenna

Step-by-step

Performing a scan project

This step-by-step procedure describes how to perform a scan from scratch. This chapter gives information on how to:

- Set up a project, new scan
- Connect to GNSS antennas
- Perform scanning
- Check and follow-up of scans
- Export the project output

Set up a project, new scan

1. Open DXplore software

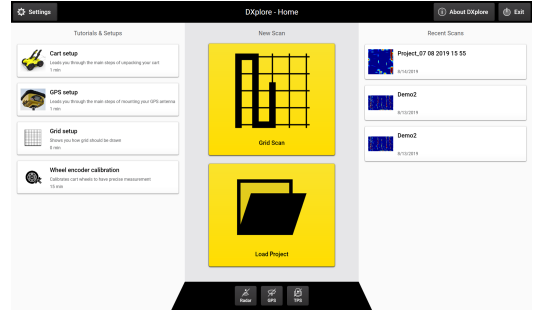

2. Connect to GNSS antenna.

Refer to "Connect the GS18 T antenna" for the GS18 T antenna.
Refer to "Connect the GG04 plus antenna" for the GG04 plus antenna.

3. Start a scan.

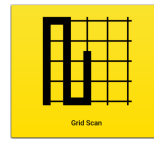

4. Enter project information.

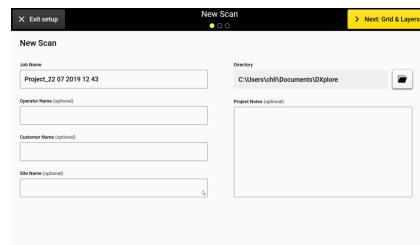

5. Define scan size, location and to import history layers as reference if any.

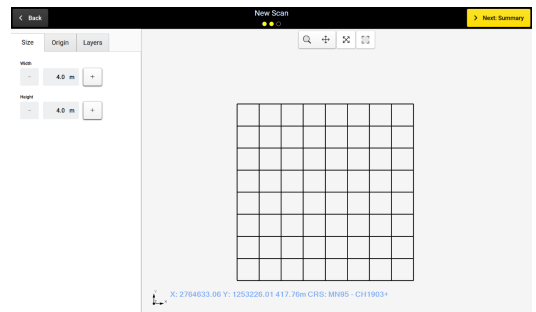

6.  On-site, DXplore is automatically streaming the antenna positions.

Point the antenna pole tip to the grid corner and tap the **Lock** button.



This position is the bottom left corner.

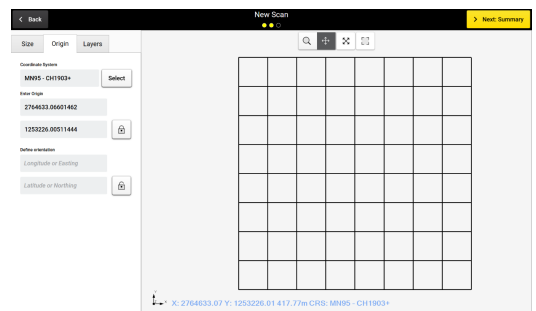

7. Go to the top left corner of the grid and tap the **Lock** button again.



Now the location and orientation are precisely defined.

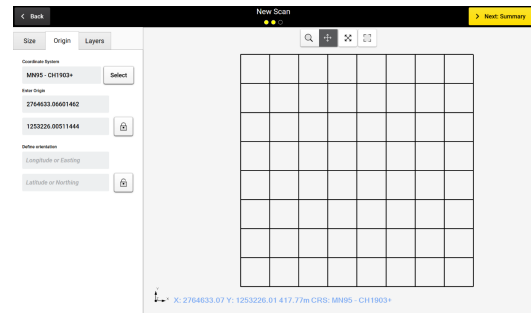

In the **Layers** Tab, either use Google Maps as the rough background or import an existing utility map in DXF format.

8. It is mandatory to specify the coordinate system of the DXF layer to position the utility map correctly. The project coordinate system (so is your grid corner coordinates) changes to the same coordinate system.

9. Zoom and pan in the viewer until reaching a preferred visualisation, then tap **Next: Summary**.

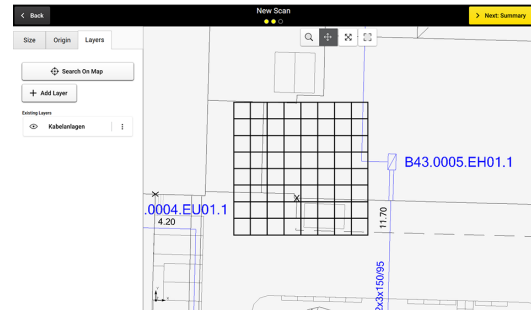

10. Confirm the information of the project summary.

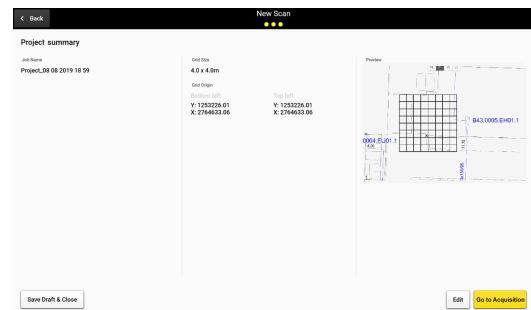

Scan

1. Make sure to have the grid physically marked on the ground surface. Refer to setup tutorial.
DSX works using grid principle relaying on scanning the ground in both parallel lines at 50 cm/18 in intervals in transversal and longitudinal directions.
Minimum supported grid size is 4 × 4 m/12 × 12 ft.
Maximum supported grid size is 11 × 11 m/33 × 33 ft.
Grids can be square or rectangular. Use measuring tapes and the grid assistance square (in DSX accessory bag) to accurately mark the grid on the ground surface.

2. Do a site check.
Tap **Add POI** to add conspicuous points of interest on site.

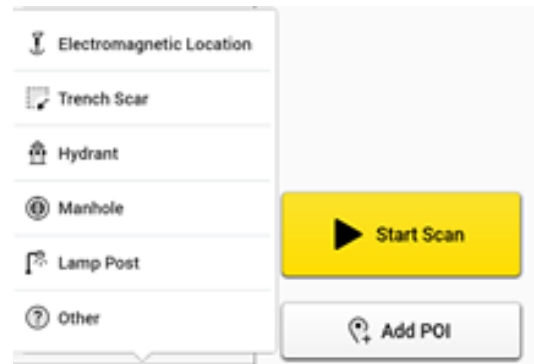

3. Adjust the cart position and direction using the arrows to coincide with the conditions on site.

4. Place the cart centre precisely on top of the starting point.

 Use the four red markers in the front, back and sides of the cart.

5. Tap **Start Scan** and start pushing the cart forward.



6. Precisely on top of the end point of the line tap **Stop Scan** to stop the cart.



7. Once the full scan is ended, tap **Analyse Data**.



Check and follow-up of scans

➔ After tapping **Analyse Data** the tomography is generated. The animation is on by default.

1. Tap the Pause button to start marking utilities.



2. Mark utilities. The software starts the verification process.

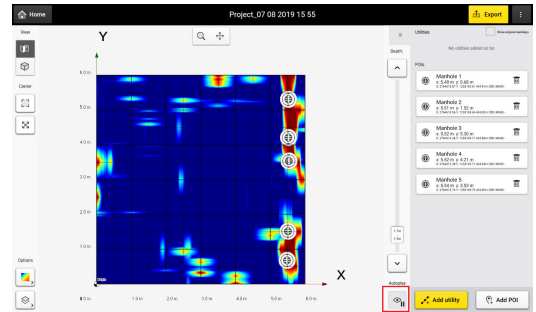

➔ It is mandatory to check on each slice to find utilities in that depth range.

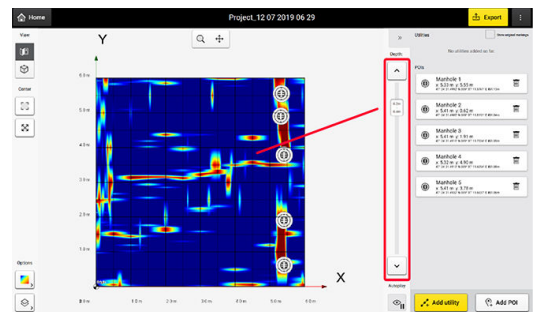

3. Tap **Add utility** and start marking the utility using your finger.



➔ DXplore then verifies it.

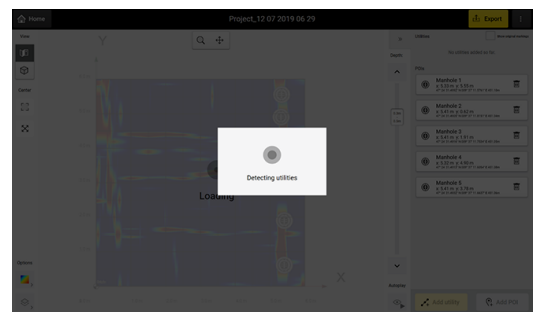

4. Utility detected. If available, make sure to enter the information correctly.

➔ The software estimates the depth.

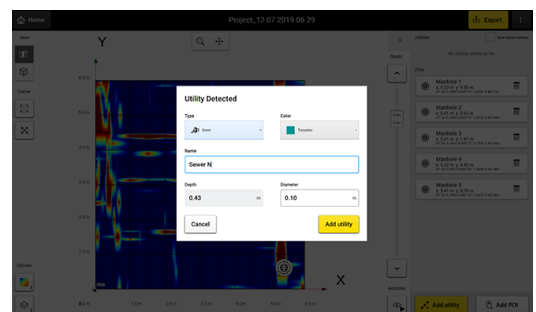

- If the utility is not found, there is still the option to keep it as an anomaly.

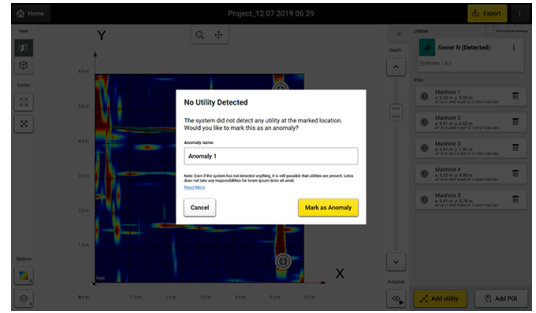

- View your utilities in 3D.

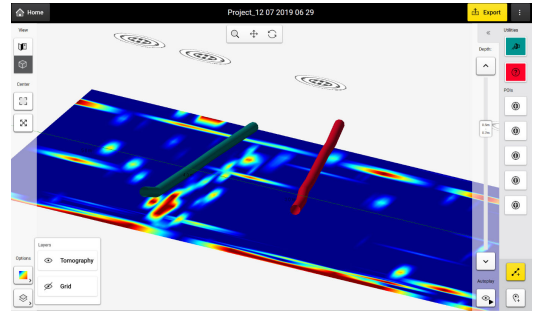

- ☞ Once all utilities are marked, continue with the export of the project output.

Export the project output

- Make sure all utilities are marked
- Tap on **Export** to export the project output



- ☞
- Utility lines and POIs in DXF format. Output in grid-based coordinate system.
 - Current tomography in image formats.
 - PDF report.
 - Export to MC1: Generates the detected utilities and scan area in DXF format, under the MC1-compatible directory structure. This option allows using the DXplore output directly on the excavator controlled by MC1 software.

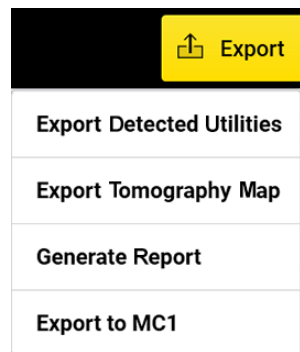

Connect the GS18 T antenna

Steps for connecting the GS18 T antenna in DXplore: (Full-integration)

1. Turn on GS18 T antenna.

2. Find the GS18 T antenna from Bluetooth device list on the tablet screen.

3. Connect to the GS18 T antenna. The password is '0000'.

4. Open DXplore.

5. Tap on the **GNSS** icon in the bottom bar of the Home screen.



 The DXplore GNSS connection window may show an empty list.

6. Tap **Detect** to get the paired antenna to the list.

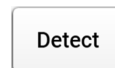

7. Enter the correct pole height.
 -  Do not consider the bottom shift from the pole tip above ground.

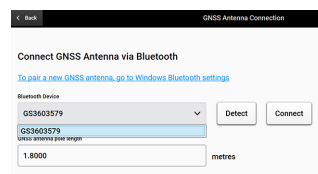

8. Tap **Connect** once the GS18 T antenna was found.



 Now the connection to the GS18 T antenna is established. Do not skip antenna configuration (uncheck) if the Real-Time Kinematic (RTK) configuration has not been set up yet.

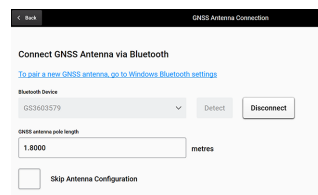

9. Enter the PIN/PUK/APN of the cellular SIM card in the next screen.

 Check if the connection is successful.

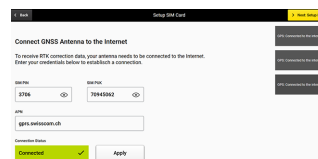

10. Enter the RTK service provider information as requested.

 Here we use SmartNet: Once the user credentials are entered, **Refresh** the RTK Network Mount Point list. Choose "iMAX-RTCM3" if available.

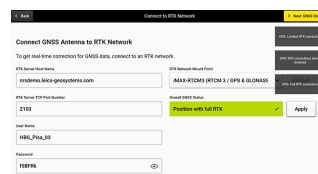
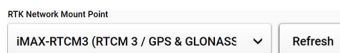

Steps for connecting the GS18 T antenna in DXplore:

Skip configuration option if RTK configuration is already done with Captivate

1. Turn on GS18 T antenna.

2. Find the GS18 T antenna from Bluetooth device list on the tablet screen.
3. Connect to the GS18 T antenna. The password is '0000'.
4. Open DXplore.
5. Tap on the **GNSS** icon in the bottom bar of the Home screen.



 The DXplore GNSS connection window may show an empty list.

6. Tap **Detect** to get the paired antenna to the list.

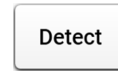

7. Remember to enter the pole height correct.

 Do not consider the bottom shift from the pole tip above ground.

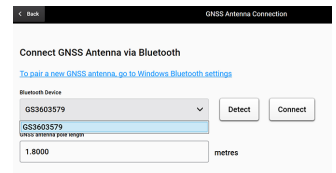

8. Tap **Connect** once the GS18 T antenna was found.



 Now the connection to the GS18 T antenna is established. Skip antenna configuration (check). DXplore reads the configuration from the GS18 T antenna.

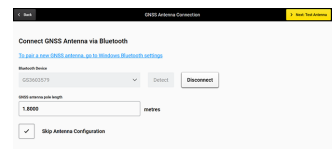

 Configuration of the GS18 T antenna is completed. The real-time position and accuracy is shown in 3D.

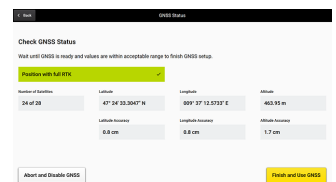

9. Tap **Use GNSS** once satisfied with the accuracy.

 If the accuracy is not high enough, tap **Disable GNSS**.



 The Home screen appears with the GNSS icon in green.

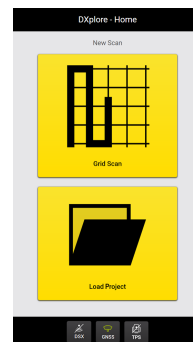

Connect the GG04 plus antenna

Steps for connecting the GG04 plus antenna in DXplore: (through Leica Zeno Connect)

1. Pair and connect to GG04 plus in Windows. Password is '0000'.

2. Open the Leica Zeno Connect application.



3. Set up the Real-Time Kinematic (RTK) corrections in Leica Zeno Connect.
 - Profiles

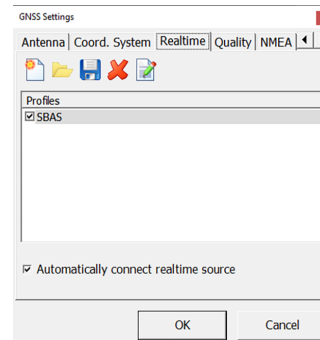

- Profile Name
- Description

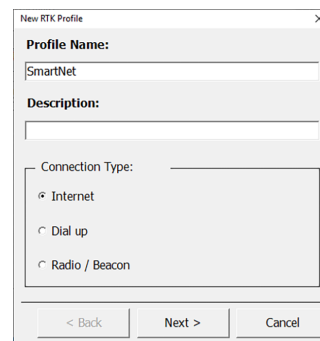

- Internet connection configuration

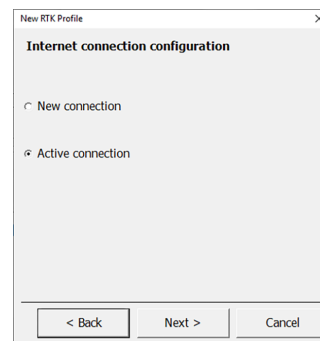

- Enter details for new server

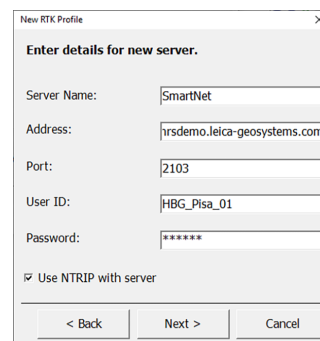

- A mountpoint is required. What would you like to do?

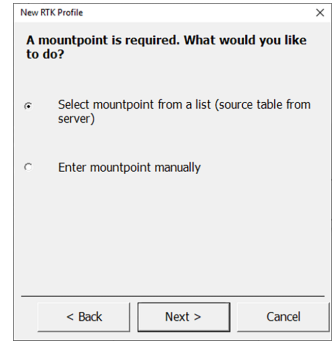

- Select a mountpoint

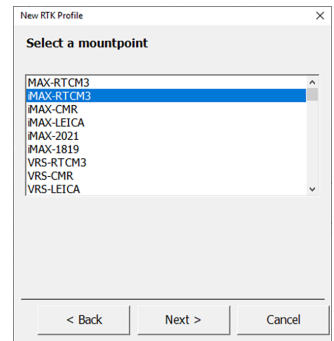

- RTK Correction Details

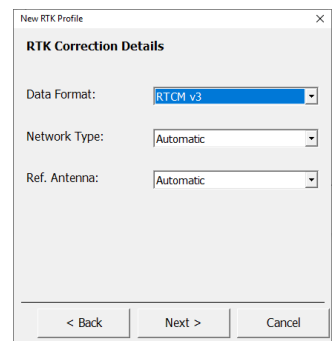

4.  Once all **Connection Status** are checked, the window automatically closes.

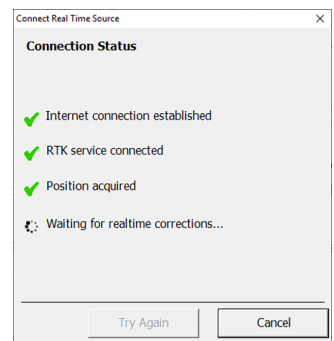

-  The positioning status of the GG04 plus antenna is shown in Leica Zeno Connect.

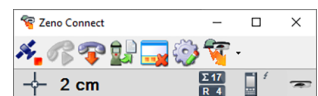

☞ If you are using the same profile, there is no need to go through the settings.

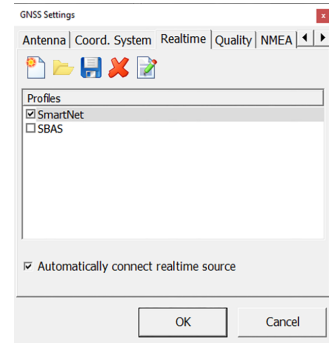

5. Tap on the connection button on the left side of the menu.



6. Other settings are not necessary in Leica Zeno Connect. DXplore gets only the corrected coordinates in WGS84 lat/Ing.

Settings in DXplore

1. Open DXplore.
2. Tap on the **GNSS** icon in the bottom bar of the Home screen.



☞ The GG04 plus antenna should be shown in the DXplore GNSS connection window.

3. Tap **Connect**.



4. Enter the correct pole height.
☞ Do not consider the bottom shift from the pole tip above ground.

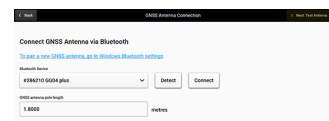

☞ Now the connection to the GG04 plus antenna is established. The real-time position and accuracy is shown.

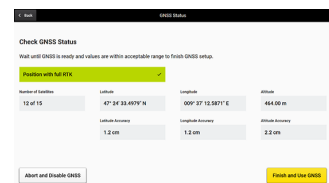

5. Tap **Use GNSS** once satisfied with the accuracy.



☞ If the accuracy is not high enough, tap **Disable GNSS**.



6. The Home screen appears with the GNSS icon in green.

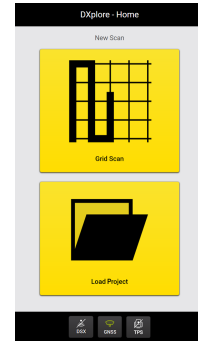

7 Care and Transport

7.1 Transport

Shipping

When transporting the product by rail, air or sea, always use the complete original Leica Geosystems packaging, container and cardboard box, or its equivalent, to protect against shock and vibration.

Shipping, transport of batteries

When transporting or shipping batteries, the person responsible for the product must ensure that the applicable national and international rules and regulations are observed. Before transportation or shipping, contact your local passenger or freight transport company.

7.2 Storage

Product

Respect the temperature limits when storing the equipment, particularly in summer if the equipment is inside a vehicle. Refer to "8 Technical Data" for information about temperature limits.

Li-Ion battery

- Refer to " Battery for control unit" for information about storage temperature range.
 - Remove batteries from the product and the charger before storing.
 - After storage recharge batteries before using.
 - Protect batteries from damp and wetness. Wet or damp batteries must be dried before storing or use.
 - A storage temperature range of 0 °C to +30 °C/+32 °F to +86 °F in a dry environment is recommended to minimise self-discharging of the battery.
 - At the recommended storage temperature range, batteries containing a 40% to 50% charge can be stored for up to one year. After this storage period the batteries must be recharged.
-

7.3 Cleaning and Drying

WARNING

Risk of electric shock during cleaning and drying

If the product is turned on during cleaning or drying you may receive an electric shock.

Precautions:

- ▶ • Ensure that all cables are disconnected, including the power supply cable.
 - Before cleaning the product, turn off the product and all other devices connected to the product.
 - Ensure that the product is dry before reconnecting cables and turning on the product.
-

Product and Accessories

- Use only a clean, soft, lint-free cloth for cleaning. If necessary, moisten the cloth with water or soapy water. Do not use other liquids; these may attack the product surface.
-

Cables and plugs

Keep plugs clean and dry. Blow away any dirt lodged in the plugs of the connecting cables.

Connectors with dust caps

Wet connectors must be dry before attaching the dust cap.

8 Technical Data

8.1 General

Dimensions

DSX

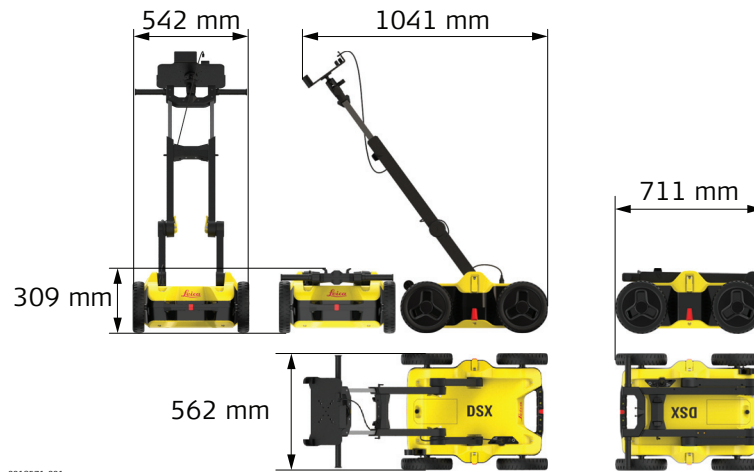

Weight

DSX – without battery and tablet	23 kg
----------------------------------	-------

Control unit

Power Consumption	13.3 W
Power Supply	12 V DC, 12 Ah SLAB (Sealed Lead Acid Battery)

Battery for control unit

Type	Rechargeable SLAB (Sealed Lead Acid Battery)
Voltage	12 V
Capacity	12 Ah

Single-frequency antenna

Antenna Footprint	40 cm × 50 cm
Number of Hardware Channels	1
Antenna Central Frequency	600 MHz
Antenna Orientation	Broadside antenna array in the direction which is perpendicular to the DSX moving direction
Sampling Frequency	400 kHz

Battery for DSX

Type	Li-Ion
Voltage	14.8 V
Capacity	GEB242 5.8 Ah
Typical operating time:	Measuring time - 8 h

Data Acquisition

Acquisition Speed	Normal walking speed, up to 7 km/h
-------------------	------------------------------------

Scan Rate per Channel – for 512 Samples per Scan	381 scans per second
Scan Interval	42 scans per metre
Positioning	<ul style="list-style-type: none"> • Two integrated encoders on the rear wheels • GNSS antenna or Total Positioning System (TPS – surveyor kit only)

Environmental specifications

Temperature

Operating temperature [°C]	Storage temperature [°C]
–10 to +40	–40 to +70
GEB242: –10 to +55	–40 to +70

Protection against water, dust and sand

Protection
IP65 (IEC 60529)

Humidity

Protection
Max 95% non-condensing The effects of condensation are to be effectively counteracted by periodically drying out the instrument.

8.2

Conformity to European Regulations

Conformity to European regulations

The equipment conforms to the following requirements set by EC regulations, including subsequent modifications, and to the legislation set by the member states that implement these regulations:

2014/53/EU Radio Directive

Warning: this equipment is destined for use in industrial environments (Class A apparatus). In residential, commercial and light industry environments, this apparatus may generate radio interference: in this case, the user may be required to operate while taking appropriate countermeasures.

The apparatus is sensitive to the presence of external electromagnetic fields, which may reduce its performance.

Receiver test according to EN 302 066 v. 2.1.0

The unit has been tested according to the provision of the EN 302 066 v. 2.1.0. Specifically, for the receiver test (that tests the influence of an interferer signal to the device), the following performance criterion has been used (see ETSI TS 103 361 v.1.1.1) .

Performance criterion: The difference D between the R_x signal noise (increased by an interferer) and the maximum input signal for the R_x in the linear region of operation.

Level of performance: $D_{\min} > 30$ dB

Software Licence Agreement

This product contains software that is preinstalled on the product, or that is supplied to you on a data carrier medium, or that can be downloaded by you online according to prior authorisation from Leica Geosystems. Such software is protected by copyright and other laws and its use is defined and regulated by the Leica Geosystems Software Licence Agreement, which covers aspects such as, but not limited to, Scope of the Licence, Warranty, Intellectual Property Rights, Limitation of Liability, Exclusion of other Assurances, Governing Law and Place of Jurisdiction. Please make sure, that at any time you fully comply with the terms and conditions of the Leica Geosystems Software Licence Agreement.

Such agreement is provided together with all products and can also be referred to and downloaded at the Leica Geosystems home page at <http://leica-geosystems.com/about-us/compliance-standards/legal-documents> or collected from your Leica Geosystems distributor.

You must not install or use the software unless you have read and accepted the terms and conditions of the Leica Geosystems Software Licence Agreement. Installation or use of the software or any part thereof, is deemed to be an acceptance of all the terms and conditions of such Licence Agreement. If you do not agree to all or some of the terms of such Licence Agreement, you must not download, install or use the software and you must return the unused software together with its accompanying documentation and the purchase receipt to the distributor from whom you purchased the product within ten (10) days of purchase to obtain a full refund of the purchase price.

900644-1.1.0en

Original text (900644en-1.1.0)

Published in Switzerland

© 2019 Leica Geosystems AG, Heerbrugg, Switzerland

Leica Geosystems AG

Heinrich-Wild-Strasse
CH-9435 Heerbrugg
Switzerland
Phone +41 71 727 31 31

www.leica-geosystems.com



- when it has to be **right**

Leica
Geosystems