

**Leica NA720/724/
728/730/730 plus
User Manual**

**Version 2.0
English**

- when it has to be **right**

Leica
Geosystems

Introduction

Purchase

Congratulations on the purchase of a Leica NA720/724/728/730/730 plus.



This manual contains important safety directions as well as instructions for setting up the product and operating it. Refer to "1 Safety Directions" for further information.

Read carefully through the User Manual before you switch on the product.

Product identification





The type and serial number of your product are indicated on the type plate. Enter the type and serial number in your manual and always refer to this information when you need to contact your agency or Leica Geosystems authorised service workshop.

Type: _____

Serial No.: _____

Symbols



The symbols used in this manual have the following meanings:

Type	Description
 DANGER	Indicates an imminently hazardous situation which, if not avoided, will result in death or serious injury.
 WARNING	Indicates a potentially hazardous situation or an unintended use which, if not avoided, could result in death or serious injury.
 CAUTION	Indicates a potentially hazardous situation or an unintended use which, if not avoided, may result in minor or moderate injury.
NOTICE	Indicates a potentially hazardous situation or an unintended use which, if not avoided, may result in appreciable material, financial and environmental damage.
	Important paragraphs which must be adhered to in practice as they enable the product to be used in a technically correct and efficient manner.

Validity of this manual

This manual applies to the NA720/724/728/730/730 plus instruments. Differences between the various models are marked and described.

Available documentation

Name	Description/Format		
NA720/724/ 728/730/730 plus User Manual	All instructions required in order to operate the product to a basic level are contained in the User Manual. Provides an overview of the product together with technical data and safety directions.		✓

Refer to the following resources for all NA720/724/728/730/730 plus documentation:

- <https://myworld.leica-geosystems.com>
-

Table of Contents

In this manual	Chapter	Page
	1 Safety Directions	7
	1.1 General Introduction	7
	1.2 Definition of Use	8
	1.3 Limits of Use	9
	1.4 Responsibilities	10
	1.5 Hazards of Use	11
	2 Description of the System	15
	2.1 Container Contents	16
	2.2 Instrument Components	17
	2.3 Understanding Terms and Expressions	18
	3 Operation	20
	3.1 Preparation	20
	3.2 Measurement	27
	3.3 Check & Adjust	37

NA720/724/728/730/730 plus, Table of Contents	6
<hr/>	
4 Care and Transport	42
4.1 Transport	42
4.2 Storage	43
4.3 Cleaning and Drying	44
5 Technical Data	45
<hr/>	
6 Accessories	48
<hr/>	

1

Safety Directions

1.1

General Introduction

Description

The following directions enable the person responsible for the product, and the person who actually uses the equipment, to anticipate and avoid operational hazards.

The person responsible for the product must ensure that all users understand these directions and adhere to them.

1.2

Definition of Use

Intended Use

- Optical height readings.
 - Optical distance measuring with stadia readings.
-

Reasonably foreseeable misuse

- Use of the product without instruction.
 - Use outside of the intended use and limits.
 - Disabling safety systems.
 - Removal of hazard notices.
 - Opening the product using tools, for example screwdriver, unless this is permitted for certain functions.
 - Modification or conversion of the product.
 - Use after misappropriation.
 - Use of products with recognisable damages or defects.
 - Use with accessories from other manufacturers without the prior explicit approval of Leica Geosystems.
 - Aiming directly into the sun.
 - Inadequate safeguards at the working site.
-

1.3

Limits of Use

Environment

Suitable for use in an atmosphere appropriate for permanent human habitation: not suitable for use in aggressive or explosive environments.



DANGER

Local safety authorities and safety experts must be contacted before working in hazardous areas, or close to electrical installations or similar situations by the person in charge of the product.

1.4

Responsibilities

Manufacturer of the product

Leica Geosystems AG, CH-9435 Heerbrugg, hereinafter referred to as Leica Geosystems, is responsible for supplying the product, including the user manual and original accessories, in a safe condition.

Person responsible for the product

The person responsible for the product has the following duties:

- To understand the safety instructions on the product and the instructions in the user manual.
 - To ensure that it is used in accordance with the instructions.
 - To be familiar with local regulations relating to safety and accident prevention.
 - To inform Leica Geosystems immediately if the product and the application becomes unsafe.
 - To ensure that the national laws, regulations and conditions for the operation of e.g. radio transmitters or lasers are respected.
-

1.5

Hazards of Use



CAUTION

Watch out for erroneous measurement results if the product has been dropped or has been misused, modified, stored for long periods or transported.

Precautions:

Periodically carry out test measurements and perform the field adjustments indicated in the user manual, particularly after the product has been subjected to abnormal use and before and after important measurements.



DANGER

Because of the risk of electrocution, it is dangerous to use poles and extensions in the vicinity of electrical installations such as power cables or electrical railways.

Precautions:

Keep at a safe distance from electrical installations. If it is essential to work in this environment, first contact the safety authorities responsible for the electrical installations and follow their instructions.



NOTICE

Strong magnetic fields in the immediate vicinity (e.g. transformers, melting furnaces...) may influence the compensator and lead to measuring errors.

Precautions:

When working near strong magnetic fields, check results for plausibility.

**CAUTION**

Be careful when pointing the product towards the sun, because the telescope functions as a magnifying glass and can injure your eyes and/or cause damage inside the product.

Precautions:

Do not point the product directly at the sun.

**WARNING**

During dynamic applications, for example stakeout procedures there is a danger of accidents occurring if the user does not pay attention to the environmental conditions around, for example obstacles, excavations or traffic.

Precautions:

The person responsible for the product must make all users fully aware of the existing dangers.

**WARNING**

Inadequate securing of the working site can lead to dangerous situations, for example in traffic, on building sites, and at industrial installations.

Precautions:

Always ensure that the working site is adequately secured. Adhere to the regulations governing safety and accident prevention and road traffic.

**CAUTION**

If the accessories used with the product are not properly secured and the product is subjected to mechanical shock, for example blows or falling, the product may be damaged or people can sustain injury.

Precautions:

When setting-up the product, make sure that the accessories are correctly adapted, fitted, secured, and locked in position.

Avoid subjecting the product to mechanical stress.

**WARNING**

If the product is used with accessories, for example masts, staffs, poles, you may increase the risk of being struck by lightning.

Precautions:

Do not use the product in a thunderstorm.

**WARNING**

If the product is improperly disposed of, the following can happen:

- If polymer parts are burnt, poisonous gases are produced which may impair health.
- If batteries are damaged or are heated strongly, they can explode and cause poisoning, burning, corrosion or environmental contamination.
- By disposing of the product irresponsibly you may enable unauthorised persons to use it in contravention of the regulations, exposing themselves and third parties to the risk of severe injury and rendering the environment liable to contamination.

Precautions:



The product must not be disposed with household waste.
Dispose of the product appropriately in accordance with the national regulations in force in your country.
Always prevent access to the product by unauthorised personnel.

Product-specific treatment and waste management information can be downloaded from the Leica Geosystems home page at <http://www.leica-geosystems.com/treatment> or received from your Leica Geosystems dealer.



WARNING

Only Leica Geosystems authorised service workshops are entitled to repair these products.

2

Description of the System

General description

The NA720/724/728/730/730 plus is a member of a new generation of construction levels.

Its innovative technology makes the daily surveying jobs easier.

The instrument is ideally suited for all applications of a reliable and robust construction level.

The easy operation of the instrument functions can be quickly learned even by inexperienced surveyors.

- Easy operation; quickly to learn!
 - Attractive design; low weight.
 - Endless drive.
 - Robust and reliable.
 - Enables angle measurements with horizontal circle (choice of ° or gon).
 - Resistant to water and dirt (IP57).
 - Adaptable to all types of tripods with 5/8" central fixing screw.
 - Nitrogen filled telescope to prevent fogging the lens.
 - 3 years without additional costs with Leica Protect.
 - Produced (in accordance to ISO 9001 and ISO 14001) and proofed with ISO 17123-2
 - Swiss technology
-

2.1 Container Contents

Container contents

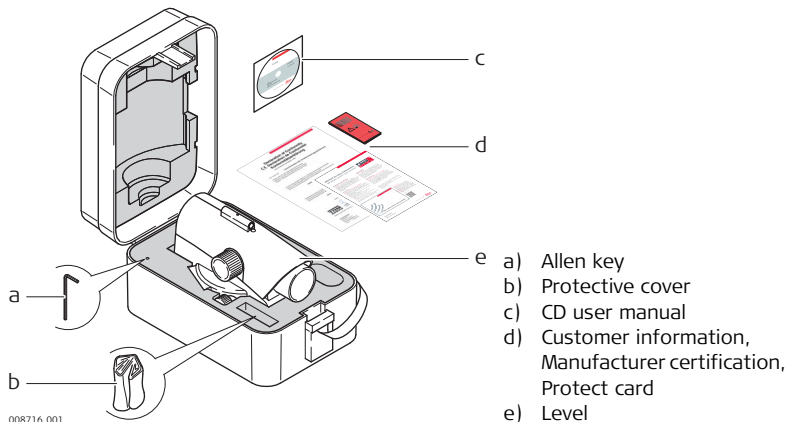

2.2

Instrument Components

Instrument components

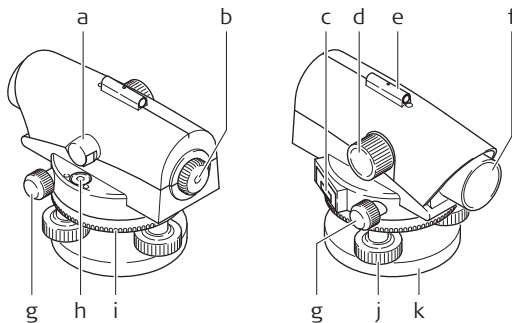

008715.001

- | | |
|--|---|
| a) Level mirror for NA720/NA724; Level prism for NA728/NA730/NA730 plus | f) Objective |
| b) Eyepiece | g) Endless drive (both sides) |
| c) Cover glass for angle reading ($^{\circ}$ or gon) | h) Circular level |
| d) Focusing knob | i) Knurled ring of adjustable horizontal circle |
| e) Coarse aiming device (back/fore-sight for NA720/NA724; optical sight with point marking for NA728/NA730/NA730 plus) | j) Footscrew |
| | k) Base plate |

2.3

Understanding Terms and Expressions

Plumb line

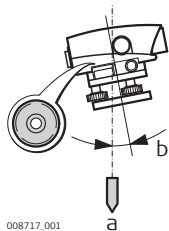

008717_001

- a) Plumb line
- b) Vertical axis tilt

By centring the circular level the instrument is nearly levelled up. A small instrument tilt remains (the vertical axis tilt).

Compensator

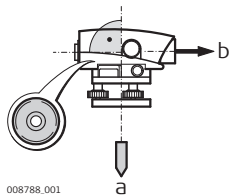

008788.001

- a) Plumb line
- b) Line of sight

The compensator in the instrument is responsible for compensating the vertical axis tilt enabling an exactly horizontal aiming.

Backsight/Fore-sight/Intermediate sight

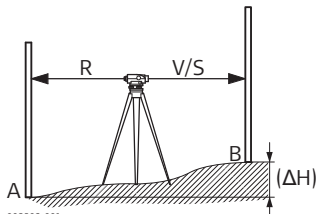

008809.001

For determining the height difference (ΔH) between the ground points A and B the back sight (R) is measured first followed by the forward sight (V). Additional points relating to A are measured as intermediate sight (S).

3 Operation

3.1 Preparation

Tripod

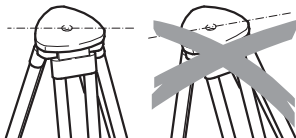

When setting up the tripod pay attention to ensuring a horizontal position of the tripod plate. Slight corrections of inclination can be made with the foot screws of the tribrach. Larger corrections must be done with the tripod legs.

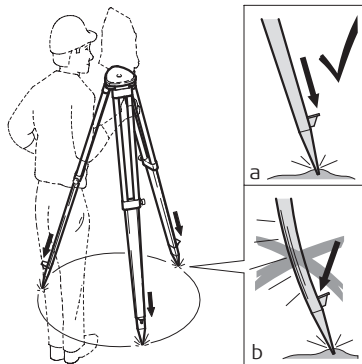

Loosen the clamping screws on the tripod legs, pull out to the required length and tighten the clamps.

- a) In order to guarantee a firm foothold sufficiently press the tripod legs into the ground.
- b) When pressing the legs into the ground note that the force must be applied along the legs.

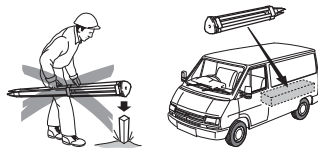

Careful handling of tripod.

- Check all screws and bolts for correct fit.
- During transport always use the cover supplied.
- Use the tripod only for surveying tasks.

**Levelling up,
step-by-step**

1. Place level onto tripod head. Tighten central fixing screw of tripod.
2. Turn footscrews of tribrach into its centre position.
3. Centre circular level by turning the foot-screws.

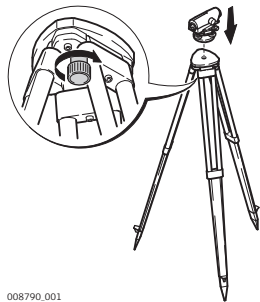

008790_001

Centring the circular level

1. Turn footscrews A and B simultaneously in opposite directions until bubble is in the centre (on the imaginary "T").

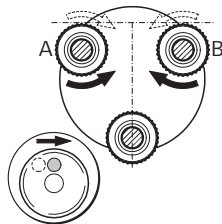

008791 001

2. Turn footscrew C until bubble is centred.

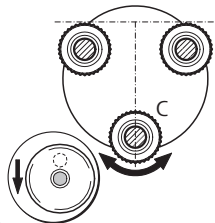

008792 001

Selection of angle reading

Changing between ° and gon:

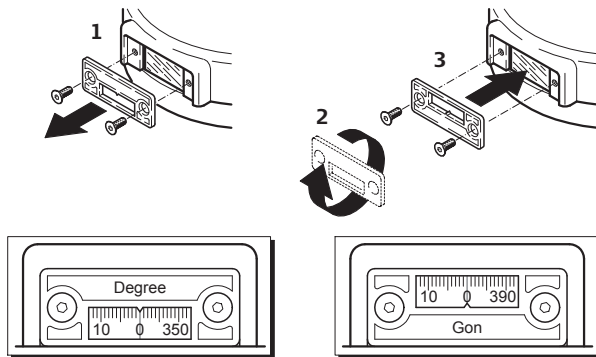

008803.001

Step	Description
1.	Loosen screws with Allen key and remove cover glass.
2.	Turn cover glass.
3.	Insert cover glass and tighten screws again.

Focusing telescope

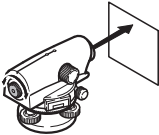
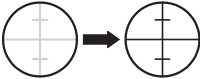
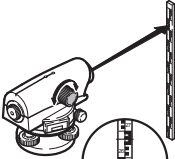
Step	Description	
1.	Aim telescope against a bright background (e.g. white paper).	  008816_001
2.	Turn eyepiece until reticle is sharp-focused and deep black. Now the eyepiece is adapted to your eye.	
3.	Aim telescope on staff using the coarse aiming device.	 008817_001
4.	Turn focusing knob until image of staff is sharply focused. If the eye is moved up and down behind the eyepiece the image of the staff and the reticle may not be displaced against each other.	

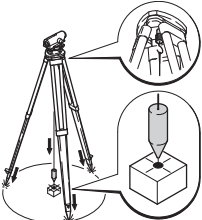

Centring

Step	Description	
For possible centring over a ground point:		
1.	Attach plumb bob.	 <p data-bbox="1103 530 1176 542">008818.001</p>
2.	Loosen central fixing screw slightly and shift instrument parallel on tripod until the plummet is exactly over the point.	
3.	Tighten central fixing screw.	

3.2

Measurement

Height reading

-  Before starting field work or after longer periods of storage/transport of your equipment check the field adjustment parameters specified in this User Manual.
-  Reduce possible vibrations by holding the tripod legs.
-  If the optical parts of your instrument are dirty or fogged, your measurements can be affected. Keep clean all optical parts of your instrument and follow the cleaning instructions specified in the User Manual.

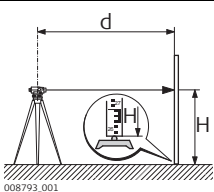
Step	Description	
1.	Setup instrument, level and sharp-focus the reticule.	
2.	Setup level staff vertically (refer also to Instruction Manual of staff).	
3.	Roughly aim on staff using the coarse aiming device.	
4.	Sharp-focus using the focusing knob.	

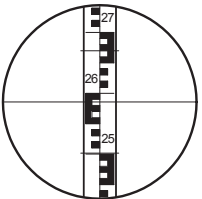
Step	Description	
5.	Fine-aim on staff using the endless drives.	 <p>008795_001</p>
6.	Check if circular level is centred (view level prism/level mirror).	
7.	Read off height H at the centre hair of the reticle. Example above: H = 2.585 m	

Distance measuring

Carry out steps 1 to 6 according to height reading.

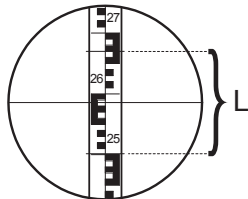

Reading:

Upper distance line: 2.670 m
Lower distance line: 2.502 m
Difference L: 0.168 m
Distance d: 16.8 m
Result: **Distance d = 100 x L**

Angle measuring

The NA720/724/728/730/730 plus is equipped with a horizontal circle. The graduation is 1° or 1 gon.

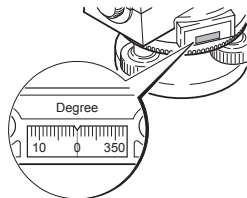

008796_001

Wanted:

Angle between point A and point B.

Carry out steps 1 to 6 according to height measuring. By doing so, align the vertical hair of the reticle to the centre of the staff.

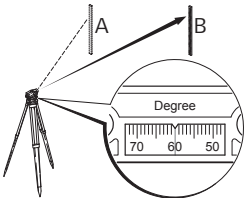
Step	Description	
1.	Turn Hz-circle to "0".	
2.	Align instrument to point B and aim on the centre of the staff.	
3.	Read off Hz-angle from Hz-circle: Example above: Hz = 60°.	

Line levelling

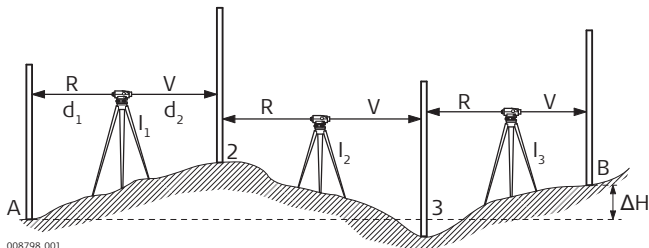

Wanted:

Height difference (ΔH) between point A and B.



Select instrument station and staff location by pacing off so, that approximately the same target distances result ($d_1 \approx d_2$; approx. 40 to 50m).

Procedure:

Step	Description
1.	Setup instrument at I_1 .
2.	Setup level staff vertically at point A.
3.	Aim on staff and read off and take down height (backsight R).
4.	Setup level at the changepoint 2, aim on staff and read off and take down height (foresight V).
5.	Setup level at I_2 , aim on staff at the changepoint 2 and read backsight and take down.
6.	Carry out a foresight at changepoint 3.
7.	Continue in the same way until height at point B is measured.

Result:

$\Delta H = \text{sum backsight} - \text{sum foresight}$

Example of the booking:

Point No.	Backsight R	Foresight V	Height
A	+2.502		650.100
2	+0.911	-1.803	
3	+3.103	-1.930	
B		-0.981	651.902
Sum	+6.516	-4.714	$\Delta H = +1.802$

Area levelling

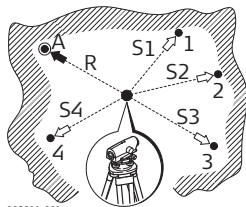

008811.001

Wanted:

Height difference of several reference points.



The required accuracy is usually not very high with such measurements. Nevertheless, from time to time read the staff on a stable intermediate point (reading must remain the same).

Procedure:

Step	Description
1.	Set up instrument centrally between the desired points. The instrument telescope may not be below the highest measured intermediate point.
2.	Set up staff vertically at reference point A.
3.	Aim on staff and read and take down height (=backsight to known point).
4.	Set up staff vertically at point 1.
5.	Aim on staff and read and take down height (=measuring intermediate point, intermediate sight)
6.	Repeat steps 4 and 5 for additional intermediate points.
7.	The height of individual points are: Height = Height of station point + backsight (A) - intermediate sight

Example of the booking:

Point No.		Interm. sight	Height
A	592.00		
R1	+2.20		
⊗	594.20		
S1		-1.80	592.40
S2		-1.90	592.30
S3		-2.50	591.70
S4		-2.30	591.90

⊗ = Instrument horizon

Levelling total station measuring

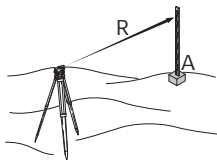

008802.001

Backsight to known point

Wanted:

Position of several ground points.



The levelling total station measuring is normally carried out during area levelling.

Procedure:

Step	Description
1.	Sequence of measurements is the same as with area levelling. However, beside the height read also the staff section L (see chapter "Distance measuring") and the Hz-angle.
2.	Transfer measured value into the map - points are determined by position and height.

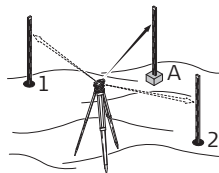
Levelled stakeout**Measuring ground points**

The stakeout is the counterpart to the levelling total station measuring - map points are set out in the field.

Procedure:

Step	Description
1.	Set up instrument at a known point, centre and level up.
2.	Focus instrument and aim on known orientation point.
3.	Orient horizontal circle (Hz-direction).
4.	Move staff to stakeout point on the basis of known values (distance and Hz-angle, height) and stakeout point.

3.3

Check & Adjust

Service the tripod step-by-step

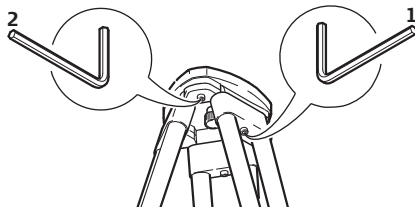



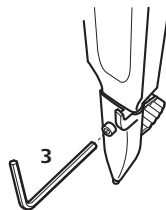

TSOK_122



The connections between metal and timber components must always be firm and tight.

- 1) Tighten the leg cap screws moderately with the allen key supplied.
- 2) Tighten the articulated joints on the tripod head just enough to keep the tripod legs open when lifting the tripod off the ground.
- 3) Tighten the screws of the tripod legs.

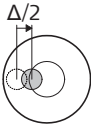
Circular Level

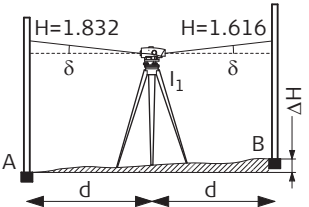

Step	Description	
1.	Level up instrument.	
2.	Turn instrument by 180°.	
3.	If bubble of level is outside the circle then it should be adjusted (see point 4.).	 <p data-bbox="1084 429 1157 440">008799_001</p>
4.	Correct the half error using an Allen key and repeat steps 2 and 3 until the bubble of level is in the centre in any telescope direction.	  <p data-bbox="1084 626 1157 637">008800_001</p>

Checking the line of sight of sight

Step	Description	
	With the circular bubble centred and adjusted, the line of sight should be horizontal.	
1.	Choose a distance of appr. 30 m within a gentle terrain.	
2.	Set up a staff at both final points (A, B).	
3.	Set up the instrument at point I_1 (halfway between A and B, just pass it down) and centre the bubble.	
4.	Read both staffs. Reading on A = 1.832 m Reading on B = 1.616 m $\Delta H = A - B = 0.216$ m	

Step	Description	
5.	Set up the level about 1 m from staff A.	<p>actual = 1.604</p> <p>nominal = 1.388</p> <p>δ</p> <p>ΔH</p> <p>A</p> <p>B</p> <p>l_2</p> <p>008980_001_en</p>
6.	Read staff A (eg.: 1.604 m).	
7.	Find nominal reading B; eg.: Reading A - $\Delta H = 1.604 \text{ m} - 0.216 \text{ m} = 1.388 \text{ m}$.	
8.	Read staff B, compare nominal- /actual- reading.	

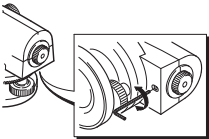
Adjusting the line of sight

Step	Description	
	When the difference nominal-/actual- reading is more than 3 mm the line of sight must be adjusted.	 008815_001
1.	Turn the allen key until the middle hair gives the required reading (eg. 1.388 m).	
2.	Check line of sight again.	
	Before starting field work or after long periods of storage/ transport of your equipment check the field adjustment parameters specified in this User Manual.	

4 Care and Transport

4.1 Transport

Transport in the field

When transporting the equipment in the field, always make sure that you

- either carry the product in its original transport container,
 - or carry the tripod with its legs splayed across your shoulder, keeping the attached product upright.
-

Transport in a road vehicle

Never carry the product loose in a road vehicle, as it can be affected by shock and vibration. Always carry the product in its transport container, original packaging or equivalent and secure it.

Shipping

When transporting the product by rail, air or sea, always use the complete original Leica Geosystems packaging, transport container and cardboard box, or its equivalent, to protect against shock and vibration.

Field adjustment

Periodically carry out test measurements and perform the field adjustments indicated in the User Manual, particularly after the product has been dropped, stored for long periods or transported.

4.2

Storage

Product

Respect the temperature limits when storing the equipment, particularly in summer if the equipment is inside a vehicle. Refer to "5 Technical Data" for information about temperature limits.

Field adjustment

After long periods of storage inspect the field adjustment parameters given in this user manual before using the product.

4.3 Cleaning and Drying

Product and accessories

- Blow dust off lenses.
- Never touch the glass with your fingers.
- Use only a clean, soft, lint-free cloth for cleaning. If necessary, moisten the cloth with water or pure alcohol. Do not use other liquids; these can attack the polymer components.

Damp products

Dry the product, the transport container, the foam inserts and the accessories at a temperature not greater than +40°C/+104°F and clean them. Do not repack until everything is dry. Always close the transport container when using in the field.

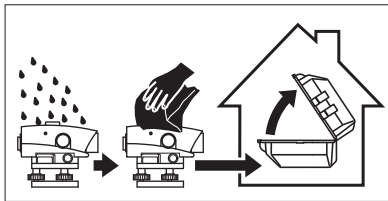

5

Technical Data

Accuracy

Standard deviation for 1 km double levelling ISO17123-2:

NA720:	2.5 mm
NA724:	2.0 mm
NA728:	1.5 mm
NA730:	1.2 mm
NA730 plus:	0.7 mm

Height accuracy for a single measurement at 30 m:

NA720:	1.5 mm
NA724:	1.2 mm
NA728:	1 mm
NA730:	0.8 mm
NA730 plus:	0.4 mm

Telescope

Erect image

Magnification

NA720:	20 x
NA724:	24 x
NA728:	28 x
NA730/NA730 plus:	30 x

	Field of view (at 100 m):	> 4 m (NA720) > 3.5 m (NA724) > 3 m (NA728/NA730/NA730 plus)
	Shortest target distance:	< 0.5 m (NA720/NA724) < 0.7 m (NA728/NA730/NA730 plus)
Distance measurement	Multiplication factor:	100 (all instruments)
	Additive constant:	0 (all instruments)
	Resolution (higher than)	4" (NA720) 3.5" (NA724) 3" (NA728/NA730/NA730 plus)
Compensator	Working range:	$\pm 15'$
	Setting accuracy (standard deviation):	0.5"
Circular level	Sensitivity:	10'/2 mm
Circle	Graduation:	360°/400gon
	Graduation interval:	1°/1gon

Adaption

To normal or ball head tripod
Central fixing screw: 5/8"

Environmental specifications**Temperature**

Operating temperature	Storage temperature
-20°C to +50°C (-4°F to +122°F)	-40°C to +70°C (-40°F to +158°F)

6 Accessories

Purchasable Accessory

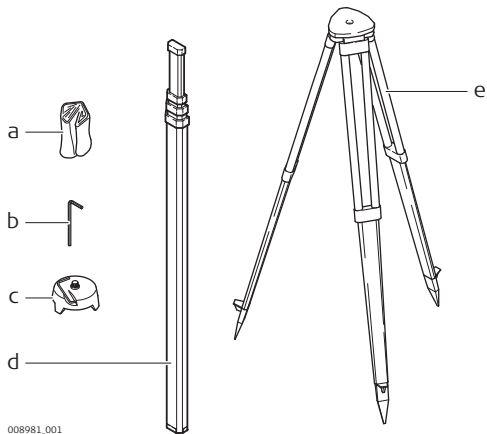

008981_001

Leica Geosystems AG

Heinrich-Wild-Strasse
CH-9435 Heerbrugg
Switzerland

Phone +41 71 727 31 31

www.leica-geosystems.com

- when it has to be **right**

Leica
Geosystems

712355-2.0.0en

Original text
Printed in Switzerland
© 2015 Leica Geosystems AG, Heerbrugg, Switzerland