

Leica GS14/GS16

User Manual



Version 4.0.1
English

- when it has to be **right**

Leica
Geosystems

Introduction

Purchase

Congratulations on the purchase of a Leica GS14/GS16 GNSS instrument.



This manual contains important safety directions as well as instructions for setting up the product and operating it. Refer to "1 Safety Directions" for further information. Read carefully through the User Manual before you switch on the product.

Product Identification

The model and serial number of your product are indicated on the type plate. Always refer to this information when you need to contact your agency or Leica Geosystems authorised service workshop.

Trademarks

- Windows is a registered trademark of Microsoft Corporation in the United States and other countries
 - *Bluetooth*[®] is a registered trademark of Bluetooth SIG, Inc.
 - microSD Logo is a trademark of SD-3C, LLC.
- All other trademarks are the property of their respective owners.

Validity of this manual

This manual applies to all models of the GS14/GS16 GNSS instrument. Where there are differences between the various instruments they are clearly described.

Available documentation

Name	Description/Format		
GS14/GS16 Quick Guide	Provides an overview of the product together with technical data and safety directions. Intended as a quick reference guide.	✓	✓
GS14/GS16 User Manual	All instructions required in order to operate the product to a basic level are contained in the User Manual. Provides an overview of the product together with technical data and safety directions.	-	✓

Name	Description/Format		
Viva Series Technical Reference Manual and Captivate Technical Reference Manual	Overall comprehensive guide to the product and application functions. Included are detailed descriptions of special software/hardware settings and software/hardware functions intended for technical specialists.	-	✓

Refer to the following resources for all GS14/GS16 documentation/software:

- the Leica USB documentation card
- <https://myworld.leica-geosystems.com>

myWorld@Leica Geosystems (<https://myworld.leica-geosystems.com>) offers a wide range of services, information and training material.

With direct access to myWorld, you are able to access all relevant services whenever it is convenient for you, 24 hours a day, 7 days per week. This increases your efficiency and keeps you and your equipment instantly updated with the latest information from Leica Geosystems.

Service	Description
myProducts	Add all products that you and your company own and explore your world of Leica Geosystems: View detailed information on your products and update your products with the latest software and keep up-to-date with the latest documentation.
myService	View the current service status and full service history of your products in Leica Geosystems service centres. Access detailed information on the services performed and download your latest calibration certificates and service reports.
mySupport	View the current service status and full service history of your products in Leica Geosystems service centres. Access detailed information on the services performed and download your latest calibration certificates and service reports.
myTraining	Enhance your product knowledge with Leica Geosystems Campus - Information, Knowledge, Training. Study the latest online training material on your products and register for seminars or courses in your country.
myTrusted Services	Add your subscriptions and manage users for Leica Geosystems Trusted Services, the secure software services, that assist you to optimise your workflow and increase your efficiency.

Table of Contents

In this manual	Chapter	Page
1	Safety Directions	6
1.1	General Introduction	6
1.2	Definition of Use	7
1.3	Limits of Use	7
1.4	Responsibilities	8
1.5	Hazards of Use	9
1.6	Electromagnetic Compatibility EMC	13
1.7	FCC Statement, Applicable in U.S.	14
1.8	ICES-003 Statement, Applicable in Canada	15
2	Description of the System	16
2.1	System Components	16
2.2	System Concept	17
2.2.1	Software Concept	17
2.2.2	Power Concept	17
2.2.3	Data Storage Concept	18
2.3	Container Contents	19
2.4	Instrument Components	21
3	User Interface	22
3.1	Keyboard	22
3.2	Operating Principles	24
4	Operation	25
4.1	Equipment Setup	25
4.1.1	Setting up as a Post-Processing Base	25
4.1.2	Setting up as a Real-Time Base	28
4.1.3	Setting up as a Real-Time Rover	32
4.1.4	Fixing the Field Controller to a Holder and Pole	35
4.1.5	Connecting to a Personal Computer	37
4.1.6	Connecting to the Web Server	40
4.2	Batteries	42
4.2.1	Operating Principles	42
4.2.2	Battery for GS14/GS16	42
4.3	Working with the Memory Device	43
4.4	Working with the RTK Device	44
4.5	LED Indicators on GS14/GS16	45
4.6	Guidelines for Correct Results with GNSS Surveys	46
5	Care and Transport	47
5.1	Transport	47
5.2	Storage	47
5.3	Cleaning and Drying	48

6	Technical Data	49
6.1	GS14/GS16 Technical Data	49
6.1.1	Tracking Characteristics GS14	49
6.1.2	Tracking Characteristics GS16	49
6.1.3	Accuracy	50
6.1.4	Technical Data	50
6.2	Conformity to National Regulations	53
6.2.1	GS14/GS16	53
6.2.2	Dangerous Goods Regulations	54
7	Software Licence Agreement	55
Appendix A	Pin Assignments and Sockets	56

1 Safety Directions

1.1 General Introduction

Description

The following directions enable the person responsible for the product, and the person who actually uses the equipment, to anticipate and avoid operational hazards.

The person responsible for the product must ensure that all users understand these directions and adhere to them.

About Warning Messages





Warning messages are an essential part of the safety concept of the instrument. They appear wherever hazards or hazardous situations can occur.

Warning messages...

- make the user alert about direct and indirect hazards concerning the use of the product.
- contain general rules of behaviour.

For the users' safety, all safety instructions and safety messages shall be strictly observed and followed! Therefore, the manual must always be available to all persons performing any tasks described here.

DANGER, WARNING, CAUTION and **NOTICE** are standardised signal words for identifying levels of hazards and risks related to personal injury and property damage. For your safety, it is important to read and fully understand the following table with the different signal words and their definitions! Supplementary safety information symbols may be placed within a warning message as well as supplementary text.

Type	Description
 DANGER	Indicates an imminently hazardous situation which, if not avoided, will result in death or serious injury.
 WARNING	Indicates a potentially hazardous situation or an unintended use which, if not avoided, could result in death or serious injury.
 CAUTION	Indicates a potentially hazardous situation or an unintended use which, if not avoided, may result in minor or moderate injury.
NOTICE	Indicates a potentially hazardous situation or an unintended use which, if not avoided, may result in appreciable material, financial and environmental damage.
	Important paragraphs which must be adhered to in practice as they enable the product to be used in a technically correct and efficient manner.

1.2

Definition of Use

Intended use

- Computing with software.
 - Recording measurements.
 - Carrying out measurement tasks using various GNSS measuring techniques.
 - Recording GNSS and point related data.
 - Remote control of product.
 - Data communication with external appliances.
 - Measuring raw data and computing coordinates using carrier phase and code signal from GNSS satellites.
-

Reasonably foreseeable misuse

- Use of the product without instruction.
 - Use outside of the intended use and limits.
 - Disabling safety systems.
 - Removal of hazard notices.
 - Opening the product using tools, for example screwdriver, unless this is permitted for certain functions.
 - Modification or conversion of the product.
 - Use after misappropriation.
 - Use of products with obvious damages or defects.
 - Use with accessories from other manufacturers without the prior explicit approval of Leica Geosystems.
 - Inadequate safeguards at the working site.
 - Controlling of machines, moving objects or similar monitoring application without additional control and safety installations.
-

1.3

Limits of Use

Environment

Suitable for use in an atmosphere appropriate for permanent human habitation: not suitable for use in aggressive or explosive environments.



DANGER

Local safety authorities and safety experts must be contacted before working in hazardous areas, or close to electrical installations or similar situations by the person in charge of the product.

Manufacturer of the product

Leica Geosystems AG, CH-9435 Heerbrugg, hereinafter referred to as Leica Geosystems, is responsible for supplying the product, including the user manual and original accessories, in a safe condition.

Person responsible for the product

The person responsible for the product has the following duties:

- To understand the safety instructions on the product and the instructions in the user manual.
 - To ensure that it is used in accordance with the instructions.
 - To be familiar with local regulations relating to safety and accident prevention.
 - To inform Leica Geosystems immediately if the product and the application becomes unsafe.
 - To ensure that the national laws, regulations and conditions for the operation of e.g. radio transmitters or lasers are respected.
 - To ensure that the radio modem is not operated without the permission of the local authorities on frequencies and/or output power levels other than those specifically reserved and intended for use without a specific permit.
The internal and external radio modems have been designed to operate on frequency ranges and output power ranges, the exact use of which differs from one region and/or country to another.
-

1.5

Hazards of Use



DANGER

Because of the risk of electrocution, it is dangerous to use poles, levelling staffs and extensions in the vicinity of electrical installations such as power cables or electrical railways.

Precautions:

Keep at a safe distance from electrical installations. If it is essential to work in this environment, first contact the safety authorities responsible for the electrical installations and follow their instructions.



WARNING

During dynamic applications, for example stakeout procedures there is a danger of accidents occurring if the user does not pay attention to the environmental conditions around, for example obstacles, excavations or traffic.

Precautions:

The person responsible for the product must make all users fully aware of the existing dangers.



WARNING

Inadequate securing of the working site can lead to dangerous situations, for example in traffic, on building sites and at industrial installations.

Precautions:

Always ensure that the working site is adequately secured. Adhere to the regulations governing safety, accident prevention and road traffic.



CAUTION

If the accessories used with the product are not properly secured and the product is subjected to mechanical shock, for example blows or falling, the product may be damaged or people can sustain injury.

Precautions:

When setting-up the product, make sure that the accessories are correctly adapted, fitted, secured, and locked in position.

Avoid subjecting the product to mechanical stress.



WARNING

If the product is used with accessories, for example masts, staffs, poles, you may increase the risk of being struck by lightning.

Precautions:

Do not use the product in a thunderstorm.

⚠ DANGER

If the product is used with accessories, for example on masts, staffs, poles, you may increase the risk of being struck by lightning. Danger from high voltages also exists near power lines. Lightning, voltage peaks, or the touching of power lines can cause damage, injury and death.

Precautions:

- Do not use the product in a thunderstorm as you can increase the risk of being struck by lightning.
- Be sure to remain at a safe distance from electrical installations. Do not use the product directly under or close to power lines. If it is essential to work in such an environment contact the safety authorities responsible for electrical installations and follow their instructions.
- If the product has to be permanently mounted in an exposed location, it is advisable to provide a lightning conductor system. A suggestion on how to design a lightning conductor for the product is given below. Always follow the regulations in force in your country regarding grounding antennas and masts. These installations must be carried out by an authorised specialist.
- To prevent damages due to indirect lightning strikes (voltage spikes) cables, for example for antenna, power source or modem should be protected with appropriate protection elements, like a lightning arrester. These installations must be carried out by an authorised specialist.
- If there is a risk of a thunderstorm, or if the equipment is to remain unused and unattended for a long period, protect your product additionally by unplugging all systems components and disconnecting all connecting cables and supply cables, for example, instrument - antenna.

Lightning conductors

Suggestion for design of a lightning conductor for a GNSS system:

1) On non-metallic structures

Protection by air terminals is recommended. An air terminal is a pointed solid or tubular rod of conducting material with proper mounting and connection to a conductor. The position of four air terminals can be uniformly distributed around the antenna at a distance equal to the height of the air terminal.

The air terminal diameter should be 12 mm for copper or 15 mm for aluminium. The height of the air terminals should be 25 cm to 50 cm. All air terminals should be connected to the down conductors. The diameter of the air terminal should be kept to a minimum to reduce GNSS signal shading.

2) On metallic structures

Protection is as described for non-metallic structures, but the air terminals can be connected directly to the conducting structure without the need for down conductors.

Air terminal arrangement, plan view

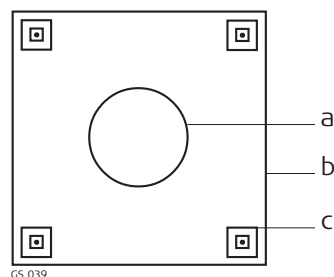

- a) Antenna
- b) Support structure
- c) Air terminal

Grounding the instrument/antenna

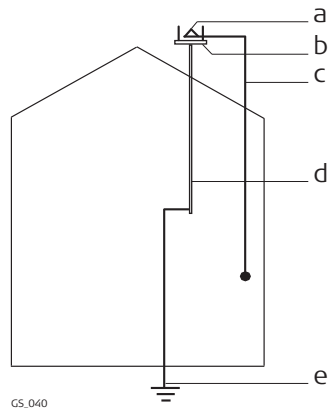

- a) Antenna
- b) Lightning conductor array
- c) Antenna/instrument connection
- d) Metallic mast
- e) Connection to earth



CAUTION

During the transport, shipping or disposal of batteries it is possible for inappropriate mechanical influences to constitute a fire hazard.

Precautions:

Before shipping the product or disposing of it, discharge the batteries by running the product until they are flat.

When transporting or shipping batteries, the person in charge of the product must ensure that the applicable national and international rules and regulations are observed. Before transportation or shipping contact your local passenger or freight transport company.



WARNING

High mechanical stress, high ambient temperatures or immersion into fluids can cause leakage, fire or explosions of the batteries.

Precautions:

Protect the batteries from mechanical influences and high ambient temperatures. Do not drop or immerse batteries into fluids.



WARNING

If battery terminals are short circuited e.g. by coming in contact with jewellery, keys, metalized paper or other metals, the battery can overheat and cause injury or fire, for example by storing or transporting in pockets.

Precautions:

Make sure that the battery terminals do not come into contact with metallic objects.



WARNING

Incorrect fastening of the external antenna to vehicles or transporters poses the risk of the equipment being broken by mechanical influence, vibration or airstream. This may result in accident and physical injury.

Precautions:

Attach the external antenna professionally. The external antenna must be secured additionally, for example by use of a safety cord. Ensure that the mounting device is correctly mounted and able to carry the weight of the external antenna (>1 kg) safely.



WARNING

If the product is improperly disposed of, the following can happen:

- If polymer parts are burnt, poisonous gases are produced which may impair health.
- If batteries are damaged or are heated strongly, they can explode and cause poisoning, burning, corrosion or environmental contamination.
- By disposing of the product irresponsibly you may enable unauthorised persons to use it in contravention of the regulations, exposing themselves and third parties to the risk of severe injury and rendering the environment liable to contamination.

Precautions:

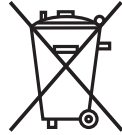

The product must not be disposed with household waste.

Dispose of the product appropriately in accordance with the national regulations in force in your country.

Always prevent access to the product by unauthorised personnel.

Product-specific treatment and waste management information can be downloaded from the Leica Geosystems home page at <http://www.leica-geosystems.com/treatment> or received from your Leica Geosystems distributor.



WARNING

Only Leica Geosystems authorised service workshops are entitled to repair these products.

Description

The term Electromagnetic Compatibility is taken to mean the capability of the product to function smoothly in an environment where electromagnetic radiation and electrostatic discharges are present, and without causing electromagnetic disturbances to other equipment.

**WARNING**

Electromagnetic radiation can cause disturbances in other equipment. Although the product meets the strict regulations and standards which are in force in this respect, Leica Geosystems cannot completely exclude the possibility that other equipment may be disturbed.

**CAUTION**

There is a risk that disturbances may be caused in other equipment if the product is used with accessories from other manufacturers, for example field computers, personal computers or other electronic equipment, non-standard cables or external batteries.

Precautions:

Use only the equipment and accessories recommended by Leica Geosystems. When combined with the product, they meet the strict requirements stipulated by the guidelines and standards. When using computers or other electronic equipment, pay attention to the information about electromagnetic compatibility provided by the manufacturer.

**CAUTION**

Disturbances caused by electromagnetic radiation can result in erroneous measurements.

Although the product meets the strict regulations and standards which are in force in this respect, Leica Geosystems cannot completely exclude the possibility that the product may be disturbed by intense electromagnetic radiation, for example, near radio transmitters, two-way radios or diesel generators.

Precautions:

Check the plausibility of results obtained under these conditions.

**CAUTION**

If the product is operated with connecting cables attached at only one of their two ends, for example external supply cables, interface cables, the permitted level of electromagnetic radiation may be exceeded and the correct functioning of other products may be impaired.

Precautions:

While the product is in use, connecting cables, for example product to external battery, product to computer, must be connected at both ends.

Radios or Digital Cellular Phones**WARNING**

Use of product with radio or digital cellular phone devices:

Electromagnetic fields can cause disturbances in other equipment, in installations, in medical devices, for example pacemakers or hearing aids and in aircraft. It can also affect humans and animals.

Precautions:

Although the product meets the strict regulations and standards which are in force in this respect, Leica Geosystems cannot completely exclude the possibility that other equipment can be disturbed or that humans or animals can be affected.

- Do not operate the product with radio or digital cellular phone devices in the vicinity of filling stations or chemical installations, or in other areas where an explosion hazard exists.
- Do not operate the product with radio or digital cellular phone devices near to medical equipment.
- Do not operate the product with radio or digital cellular phone devices in aircraft.

1.7

FCC Statement, Applicable in U.S.



The greyed paragraph below is only applicable for products without radio.



WARNING

This equipment has been tested and found to comply with the limits for a Class B digital device, pursuant to part 15 of the FCC rules. These limits are designed to provide reasonable protection against harmful interference in a residential installation. This equipment generates, uses and can radiate radio frequency energy and, if not installed and used in accordance with the instructions, may cause harmful interference to radio communications. However, there is no guarantee that interference will not occur in a particular installation. If this equipment does cause harmful interference to radio or television reception, which can be determined by turning the equipment off and on, the user is encouraged to try to correct the interference by one or more of the following measures:

- Reorient or relocate the receiving antenna.
- Increase the separation between the equipment and the receiver.
- Connect the equipment into an outlet on a circuit different from that to which the receiver is connected.
- Consult the dealer or an experienced radio/TV technician for help.



WARNING

Changes or modifications not expressly approved by Leica Geosystems for compliance could void the user's authority to operate the equipment.

Labelling GS14

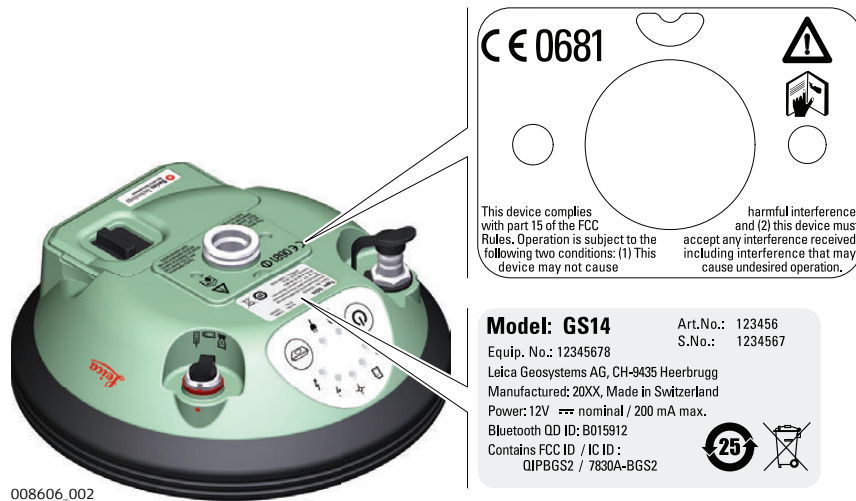

Labelling GS16



Labelling internal battery GEB212

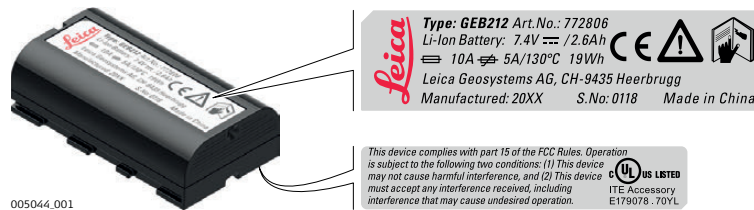

1.8

ICES-003 Statement, Applicable in Canada



WARNING

This Class (B) digital apparatus complies with Canadian ICES-003.
 Cet appareil numérique de la classe (B) est conforme à la norme NMB-003 du Canada.

2 Description of the System

2.1 System Components

Main components

Component	Description
Instrument	To calculate a position from the computed ranges to all visible GNSS (Global Navigation Satellite System) satellites.
Web server	Web-based tool to preprogram the GNSS instrument.
Antenna	To receive the satellite signals from the GNSS satellites.
Leica Geo Office, Leica Infinity	The office software including a series of help programs which support working with Leica instruments.

Instrument

Instrument	Description
GS14	GPS, GLONASS, BeiDou and Galileo GNSS receiver, dual frequency, SBAS (EGNOS, WAAS, MSAS, GAGAN), code and phase, real-time capable
GS16	GPS, GLONASS, BeiDou and Galileo GNSS receiver, multi-frequency, SBAS (EGNOS, WAAS, MSAS, GAGAN), code and phase, real-time capable

2.2

System Concept

2.2.1

Software Concept

Description

All instruments use the same software concept.

Software for all GS GNSS instruments

Software type	Description
GS firmware (GS_xx.fw)	This important software covers all functions of the instrument. The Web server application is integrated into the firmware and cannot be deleted. The English language is integrated into the firmware and cannot be deleted.
Language software (WEB_LANG.sxx)	Numerous languages are available for the Web server application. The English language is the default language. One language is chosen as the active language.

Software upload



Uploading GS firmware can take some time. Ensure that the battery is at least 75% full before beginning the upload, and do not remove the battery during the upload process.

Software for	Description
All GS models	The software can be uploaded using the Leica Web server application or myWorld@Leica Geosystems.  Ensure that a Leica microSD card is inserted into the GS instrument before starting the upload. Refer to "4.3 Working with the Memory Device".

2.2.2

Power Concept

General

Use the batteries, chargers and accessories recommended by Leica Geosystems to ensure the correct functionality of the instrument.

Power options

Power for the instrument can be supplied either internally or externally. Up to two external power supplies can be connected.

Internal power supply:

One battery (GEB212) fits into the instrument.

External power supply:

GEB371 battery connected via a cable.

OR

Car battery connected via a converter cable supplied by Leica Geosystems.

OR



10.5 V-28 V DC power supply via a converter cable supplied by Leica Geosystems.

OR

110 V/240 V AC to 12 V DC power supply unit, supplied by Leica Geosystems.



For permanent operations use **Uninterruptible Power Supply** units as a back-up in a main power failure.

Description	Data (Leica GNSS raw data and RINEX data) can be recorded on the microSD card.
Memory device	<p>microSD card: The GS14/GS16 GNSS instrument has a microSD card slot fitted as standard. A microSD card can be inserted and removed. Available capacity: 1 GB</p> <p> While other microSD cards can be used, Leica Geosystems recommends to only use Leica microSD cards and is not responsible for data loss or any other error that can occur while using a non-Leica card.</p>
	<p>Unplugging connecting cables, removing the data storage device or interrupting the power supply during the measurement can cause loss of data. Only remove the data storage device, unplug connecting cables or interrupt the power supply when the GS GNSS instrument is switched off.</p>
	<p>microSD cards can, with the supplied adaptor, also be used in an OMNI drive as supplied by Leica Geosystems. Other PC card drives can require an adaptor.</p>

2.3

Container Contents

Container for GS instrument and accessories 1/2

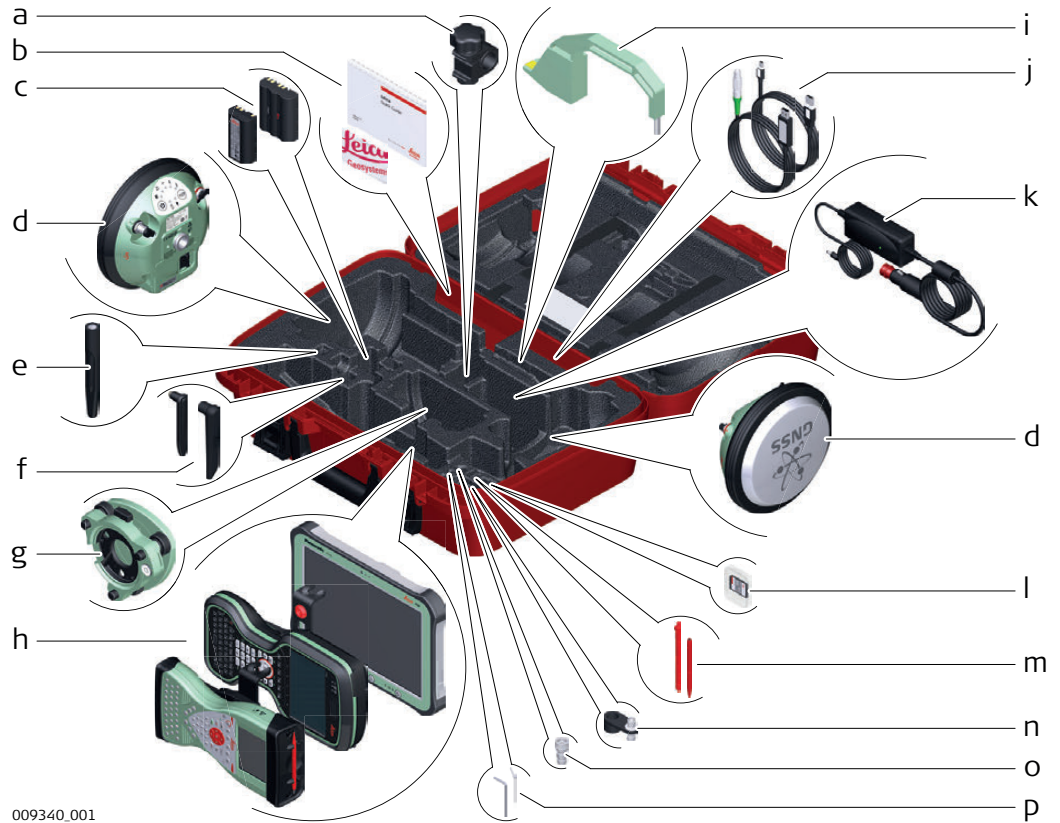

- a) GHT63 clamp
- b) Manuals and USB documentation card
- c) GEB212 or GEB311 batteries
- d) Antenna
- e) GAT18 mobile antenna
- f) GAT21, GAT25 or GAT26 radio antenna
- g) Tribach
- h) CS15 field controller with GHT62_only holder or CS20 field controller with GHT66 holder or CS35 tablet
- i) Height hook
- j) Cables
- k) GDC221 car adapter
- l) SD cards
- m) Stylus
- n) GAD34 arm 3 cm
- o) TNC QN-adapter
- p) Allen key and adjustment tool

Container for GS instrument and accessories 2/2

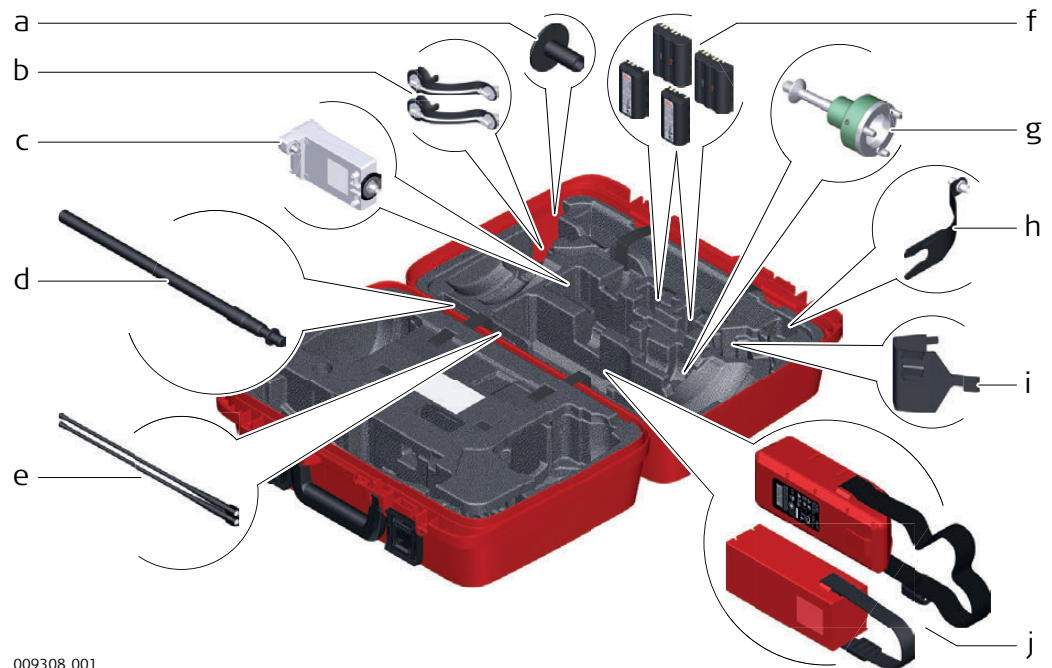

009308_001

- a) GHT36 base for telescopic rod
- b) GAD108 arm
- c) GFU RTK modem
- d) GAD32 telescopic rod
- e) GAT1 or GAT2 radio antennas
- f) GEB212 or GEB311 batteries
- g) GRT146 carrier
- h) GAD33 arm
- i) GHT58 tripod bracket for GFU
- j) External battery

2.4

Instrument Components



The instrument can be preprogrammed using the Web server application running from the instrument on a web browser of a Windows device. Connect the instrument to a computer using a cable. Turn on the instrument by holding down the Power key for 2 s. A green blinking light at both power LEDs indicates that the instrument powers up.

GS14/GS16 components

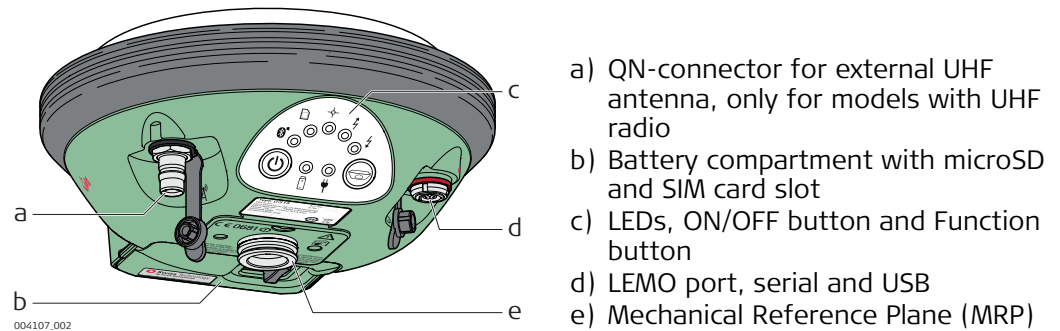

A Bluetooth port is included inside all GS GNSS instruments to enable connectivity to the field controller.

3 User Interface

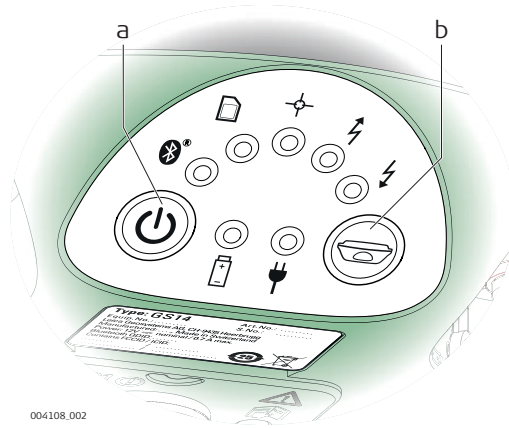

3.1 Keyboard

Keyboard GS14/GS16





a) ON/OFF button
b) Function button

ON/OFF button

Button	Function
ON/OFF 	<p>If GS14/GS16 already off: Turns on GS14/GS16 when held for 2 s.  While the GS14/GS16 is booting the two Power LEDs are lighted. Once the GS14/GS16 has started, the normal LED behaviour starts.</p> <p>If GS14/GS16 already on: Turns off GS14/GS16 when held for 2 s.  The Storage, Position, RTK Base and RTK Rover LEDs shine red, both Power and the Bluetooth LEDs shine yellow and then are turned off.</p>



Function button

 All functions following described assume the GS14/GS16 is already on.

Button	Function
Function 	<p>Press and hold button for < 1 s.</p> <p>If the GS14/GS16 is in:</p> <ul style="list-style-type: none"> base mode: The GS14/GS16 switches to be in rover mode. rover mode and in static mode: The GS14/GS16 switches to be in base mode. rover mode and in kinematic mode: The GS14/GS16 switches to be in base mode. <p>Press and hold button for 3 s.</p> <p>If the GS14/GS16 is in:</p> <ul style="list-style-type: none"> base mode and a position is available: The RTK base LED flashes green for 2 s. The GS14/GS16 takes the next available position and updates the coordinates of the currently stored RTK base position. base mode and no position is available: The RTK base LED flashes yellow for 2 s. rover mode: No action.

Button	Function
	<p>Press and hold button for 5 s.</p> <p>If the GS14/GS16 is in:</p> <ul style="list-style-type: none"> • base mode: No action. • rover mode and configured for a dial-up or Ntrip connection: The RTK rover LED flashes green for 2 s. The GS14/GS16 will connect to the RTK base station or the Ntrip server configured.
	<ul style="list-style-type: none"> • rover mode and not configured for a dial-up or Ntrip connection: No action.

Button combinations

Button	Function
ON/OFF 	Press and hold buttons for 1 s.
Function 	<p>The current almanacs stored on the GNSS instrument are deleted and new almanacs are downloaded. The Position LED flashes red quickly three times.</p>
	<p>Press and hold buttons for 5 s.</p> <p>The Memory LED flashes red quickly three times. The microSD card of the GNSS instrument is formatted. The Memory LED continues to flash red as the SD card is formatted.</p>
	<p>Press and hold buttons for 10 s.</p> <p>The System RAM on the GNSS instrument is formatted. Settings of all installed software will be deleted. The Storage, RTK Base and RTK Rover LEDs flash red. The Position LED flashes yellow quickly three times. After the formatting the System RAM, the GNSS instrument is turned off.</p>
	<p>Press and hold buttons for 15 s.</p> <p>The registry of the GNSS instrument is deleted. Windows CE and communication settings will be reset to factory defaults. The Storage, RTK Base and RTK Rover LEDs flash red. The Position LED flashes yellow quickly three times. After deleting the registry, the GNSS instrument is turned off.</p>

Operating the instrument

The GS14/GS16 GNSS instrument is operated either by the pressing its buttons (ON/OFF button, function button) or by the field controller.

Operation by buttons

The GS14/GS16 GNSS instrument is operated by pressing its buttons. Refer to "3.1 Keyboard" for a detailed description of the buttons and their function.

Operation by field controller

The GS14/GS16 GNSS instrument is operated by the field controller using the Leica SmartWorx Viva/Leica Captivate software. Refer to the User Manual of the field controller for a detailed description of the keys and their function.

Turn on GS14/GS16

To turn on the instrument press and hold the Power button for 2 s.

Turn off GS14/GS16

To turn off the instrument:

- press and hold the ON/OFF button for 2 s
 - confirm to power down the instrument when exiting the software on the field controller
-

4

Operation

4.1

Equipment Setup

4.1.1

Setting up as a Post-Processing Base

Use

The equipment setup described is used for static operations over markers.

Description

The instrument can be programmed with the field controller before use which can then be omitted from the setup.



- The antenna is mounted directly using screw fitting. If using stub and adapter, procedures can vary slightly.
 - When using the adapter and carrier, ensure that the antenna and the adapter assembly slide down the full length of the carrier stub. An incorrectly mounted antenna will have a direct effect on the results.
-



If the instrument is left in the container during use in high temperatures, the lid should be left open. Refer to the User Manual for operating and storage temperatures.



Use an external battery such as GEB371 to ensure operation for a full day.

Equipment setup

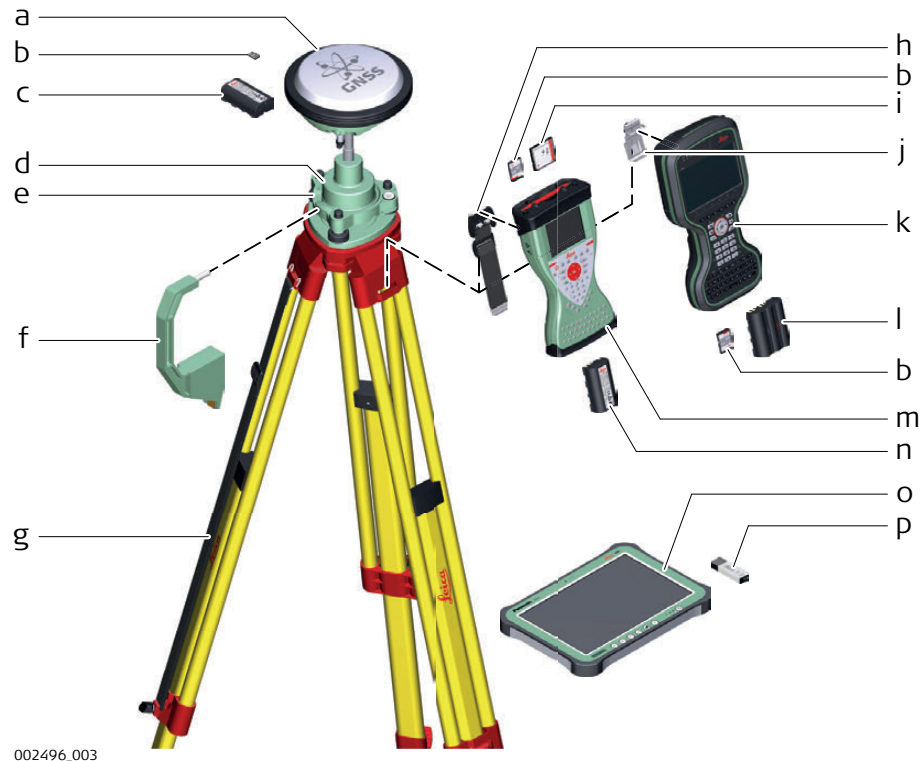

002496_003

- a) GS instrument
- b) (micro)SD card
- c) GEB212 battery
- d) GRT146 carrier
- e) Tribrach
- f) Height hook
- g) Tripod
- h) GHT61 hand strap
- i) CompactFlash card
- j) Utility hook
- k) CS20 field controller
- l) GEB331 battery
- m) CS15 field controller
- n) GEB212 battery
- o) CS35 tablet
- p) USB stick

Equipment setup step-by-step

Step	Description
1.	Set up the tripod.
2.	Mount and level the tribrach on the tripod.
3.	Ensure that the tribrach is over the marker.
4.	Place and lock the carrier in the tribrach.
5.	Insert the data storage device and the batteries into the GS.
6.	Screw the GS onto the carrier.
7.	Check that the tribrach is still level.
8.	Insert the data storage device and the battery into the field controller.
9.	Switch on the field controller and connect it to the instrument if necessary.
10.	To hang the field controller on the tripod leg, use the hook on the hand strap or use the utility hook. Refer to the User Manual of the field controller.
11.	Insert the height hook into the carrier.
12.	Measure the antenna height using the height hook.
13.	Press the ON/OFF button on the instrument for at least 2 s to switch on the instrument.

Use

The equipment setup described is used for real-time base stations with the need of optimal radio coverage. Raw observation data can also be collected for post-processing.

Description

The GS14/GS16 instrument can be programmed with the field controller before use which can then be omitted from the setup. The connection between GS14/GS16 and the field controller is made via Bluetooth. The radio antenna is mounted on the antenna arm which clips to the GNSS antenna.



- The antenna is mounted directly using screw fitting. If using stub and adapter, procedures can vary slightly.
 - When using the adapter and carrier, ensure that the antenna and the adapter assembly slide down the full length of the carrier stub. An incorrectly mounted antenna will have a direct effect on the results.
 - Standard radio is used throughout the instructions. Digital cellular phones can also be used but the setup can differ slightly.
-



If the instrument is left in the container during use in high temperatures, the lid should be left open. Refer to the User Manual for operating and storage temperatures.



Use an external battery such as GEB371 to ensure operation for a full day.

Equipment setup

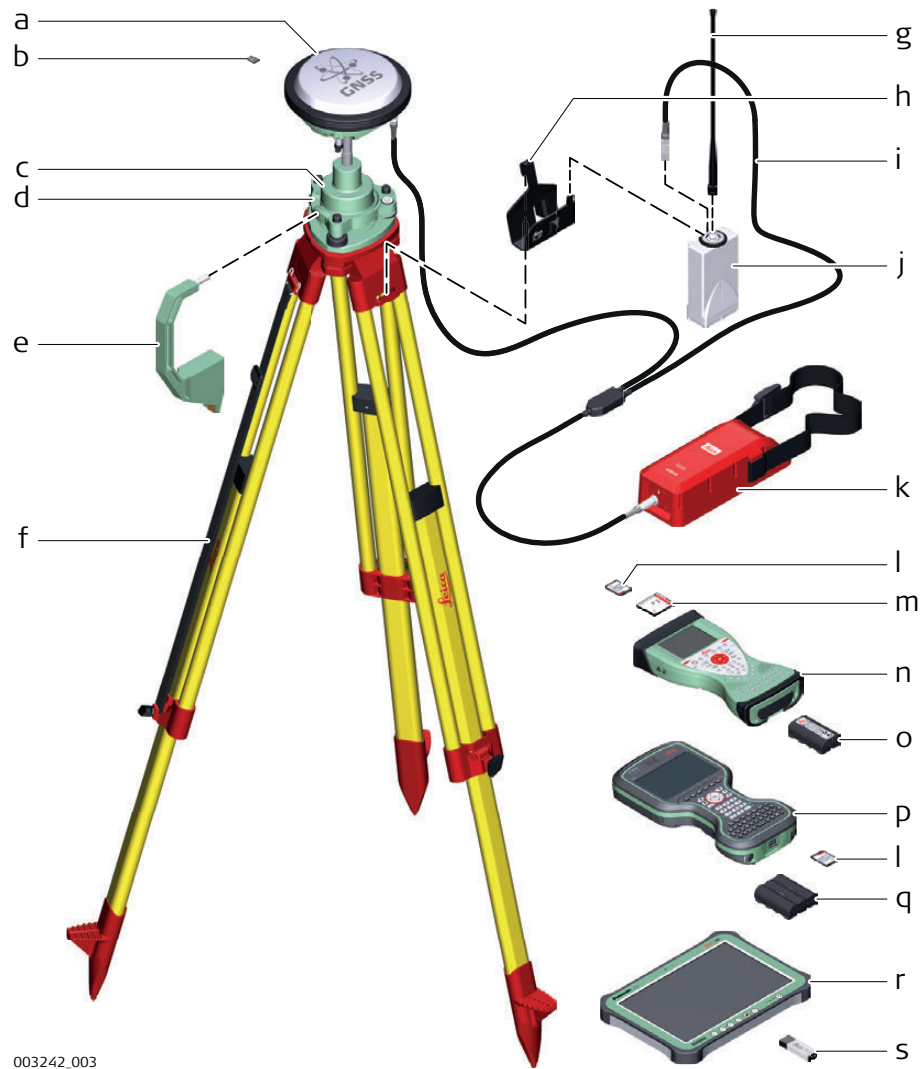

003242_003

- a) GS instrument
- b) microSD card
- c) GRT146 carrier
- d) Tribrach
- e) Height hook
- f) Tripod
- g) GAT1/GAT2 radio antenna
- h) GHT58 tripod bracket
- i) GEV264 Y-cable
- j) GFU radio modem
- k) GEB371 external battery
- l) SD card
- m) CompactFlash card
- n) CS15 field controller
- o) GEB212 battery
- p) CS20 field controller
- q) GEB331 battery
- r) CS35 field controller
- s) USB stick

**Equipment setup -
GS14/GS16
GSM/UMTS or
GS14/GS16 UHF**

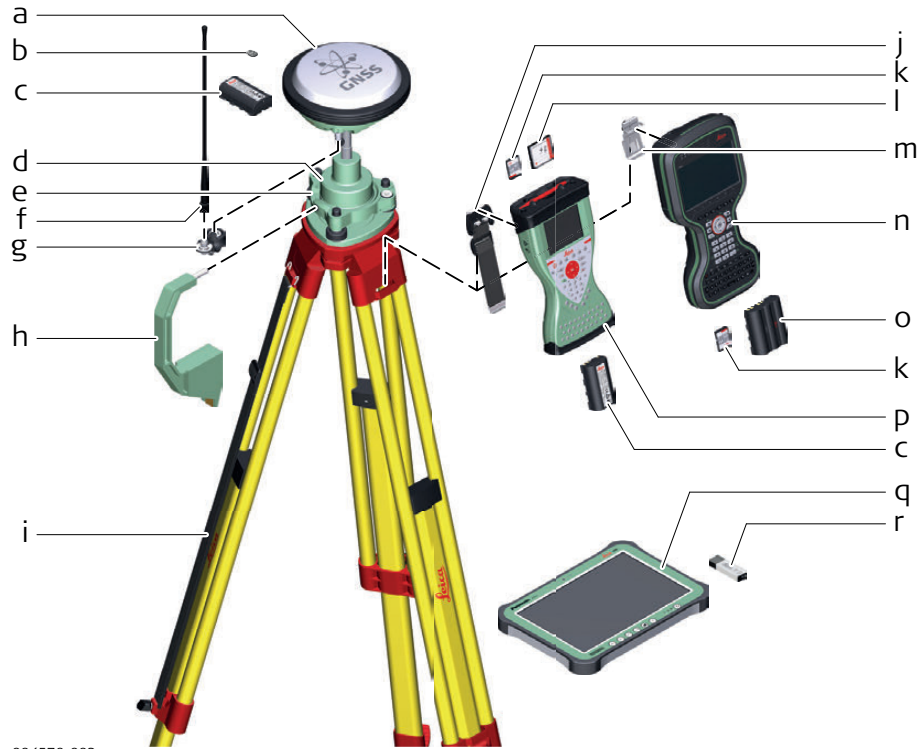

004570_003

- a) GS14/GS16 instrument with integrated GSM/UMTS modem or UHF (transmit) modem
- b) microSD card
- c) GEB212 battery
- d) GRT146 carrier
- e) Tribrach
- f) GAT1/GAT2 radio antenna
- g) GAD108 arm, for UHF use only
- h) Height hook
- i) Tripod
- j) GHT61 hand strap
- k) SD card
- l) CompactFlash card
- m) Utility hook
- n) CS20 field controller
- o) GEB331 battery
- p) CS15 field controller
- q) CS35 tablet
- r) USB stick

Equipment setup step-by-step

Step	Description	
1.	Set up the tripod.	
2.	Mount and level the tribrach on the tripod.	
3.	Ensure that the tribrach is over the marker.	
4.	Place and lock the carrier in the tribrach.	
	GS with external RTK device	GS14/GS16
5.	Screw the GS onto the carrier.	Insert the data storage device and the batteries into the GS14/GS16.
6.	Check that the tribrach is still level.	Press the ON/OFF button on the instrument for at least 2 s to switch on the instrument.
7.	Hang the external battery onto a tripod leg.	Screw the GS14/GS16 onto the carrier.
8.	Hang the tripod bracket onto a tripod leg and attach the radio housing onto the tripod bracket.	Check that the tribrach is still level.
9.	Connect the GEV205 cable to the GS08plus or the GEV264 cable to the GS14/GS16, to the external battery and to the radio housing.	Insert the data storage device and the battery into the field controller.
10.	Insert the data storage device and the battery into the field controller.	Connect the field controller to the instrument if necessary.
11.	Connect the field controller to the instrument if necessary.	To hang the field controller on the tripod leg, use the hook on the hand strap or use the utility hook. Refer to the User Manual of the field controller.
12.	To hang the field controller on the tripod leg, use the hook on the hand strap or use the utility hook. Refer to the User Manual of the field controller.	Insert the height hook into the carrier.
13.	Insert the height hook into the carrier.	Measure the antenna height using the height hook.
14.	Measure the antenna height using the height hook.	Press the ON/OFF button on the instrument for at least 2 s to switch on the instrument.
15.	Press the ON/OFF button on the instrument for at least 2 s to switch on the instrument.	-

Use

The equipment setup is used for real-time rover with extended periods of use in the field.

Description

Connections are made to the GNSS antenna, radio antenna and field controller. The field controller is fixed to the pole with the GHT62. Connection between the GS14/GS16 instrument and the field controller is made through Bluetooth.



- The antenna is mounted directly using screw fitting. If using stub and adapter, procedures can vary slightly.
 - When using the pole with stub, ensure that the antenna and the screw-to-stub adapter slide down the full length of the stub before tightening the locking ring. An incorrectly mounted antenna will have a direct effect on the results.
 - Aluminium poles are used. They can be replaced with their carbon fibre equivalent without any change to these instructions.
 - Standard radio is used throughout the instructions. Digital cellular phones can also be used but the setup can differ slightly.
-

Equipment setup

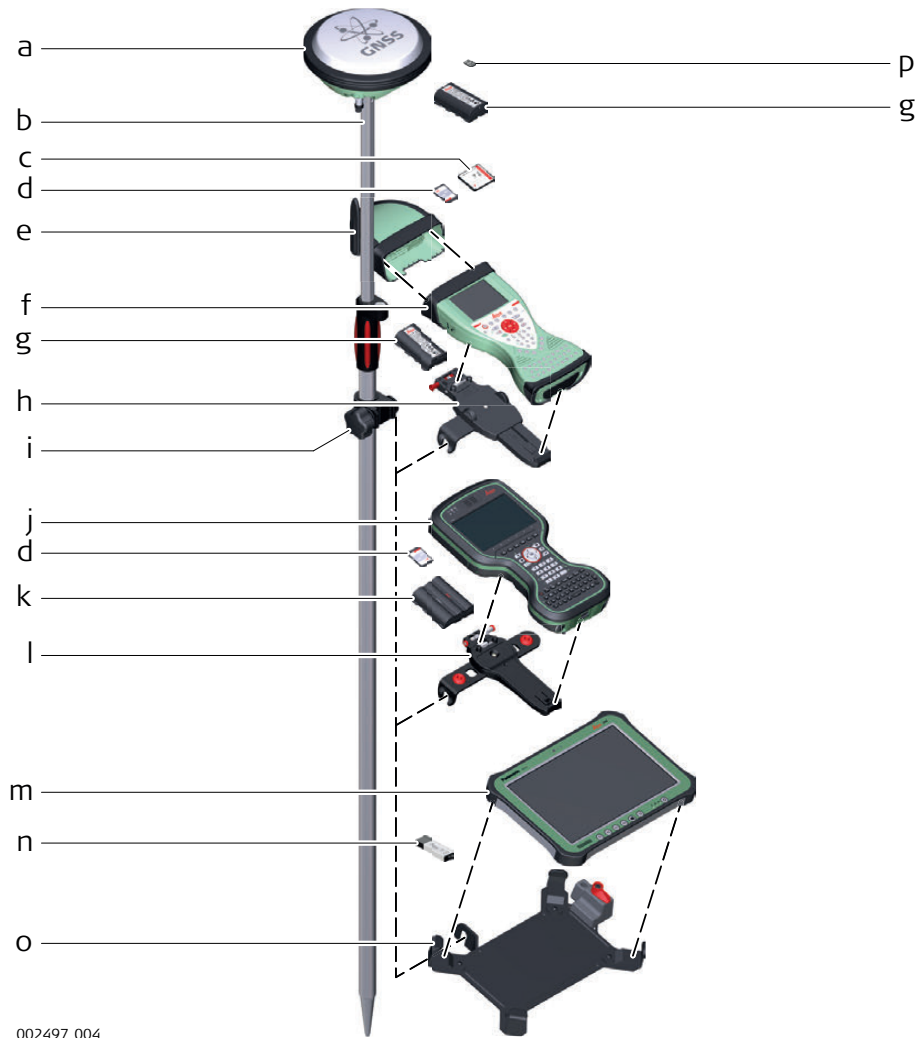

002497.004

- a) GNSS antenna
- b) Pole
- c) CompactFlash card
- d) SD card
- e) CGR radio
- f) CS15 field controller
- g) GEB212 battery
- h) GHT62 holder
- i) GHT63 pole clamp
- j) CS20 field controller
- k) GEB331 battery
- l) GHT66 holder
- m) CS35 tablet
- n) USB stick
- o) GHT78 holder
- p) mircoSD card

**Equipment setup -
GS14/GS16 UHF**

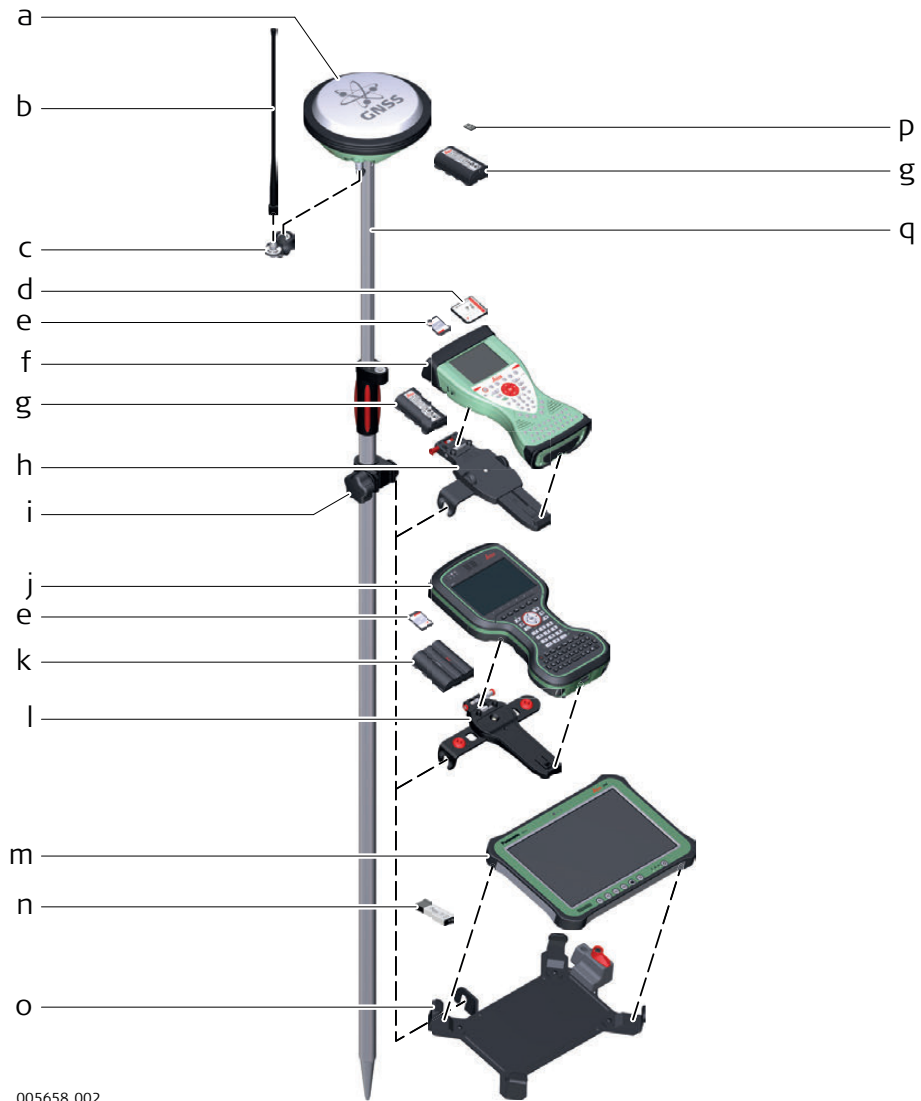

005658_002

- a) GS14/GS16 GNSS antenna with integrated UHF radio modem
- b) GAT1/GAT2 radio antenna
- c) GAD108 arm
- d) CompactFlash card
- e) SD card
- f) CS15 field controller
- g) GEB212 battery
- h) GHT62 holder
- i) GHT63 pole clamp
- j) CS20 field controller
- k) GEB331 battery
- l) GHT66 holder
- m) CS35 tablet
- n) USB stick
- o) GHT78 holder
- p) microSD card
- q) Pole

Equipment setup step-by-step

Step	Description
1.	Attach the GHT62 for CS15 or the GHT66 for CS20 holder to the pole.
2.	Insert the data storage device and the battery into the field controller.
3.	Clip the field controller into the holder and lock it by pushing the locking pin into the locked position.
4.	Press ON/OFF button on the field controller to switch on.
5.	Insert the data storage device and the batteries into the GS14/GS16.
6.	Press ON/OFF button on the GS14/GS16 to switch on.
7.	Screw the GS14/GS16 to the top of the pole.
8.	The field controller and GS14/GS16 are connected via Bluetooth.

4.1.4

Fixing the Field Controller to a Holder and Pole



This chapter is valid for all holders.

Components of the GHT66 Holder

The GHT66 holder consists of the following components:

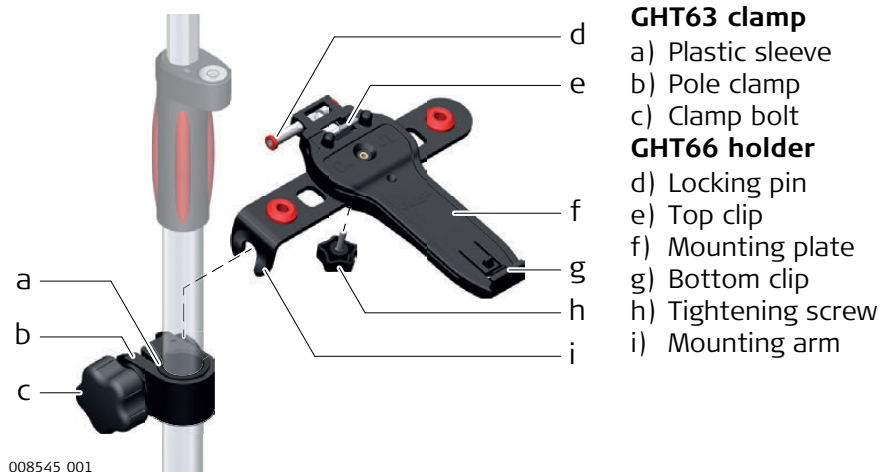

Fixing the Field Controller and GHT66 to a Pole Step-by-step

Step	Description
	For an aluminium pole, fit the plastic sleeve to the pole clamp.
1.	Insert the pole into the clamp hole.
2.	Attach the holder to the clamp using the clamp bolt.
3.	Adjust the angle and the height of the holder on the pole to a comfortable position.
4.	Tighten the clamp with the clamp bolt.
5.	Before placing the CS field controller onto the mounting plate, ensure that the locking pin is put into the unlocked position. To unlock the locking pin, push the locking pin to the left.

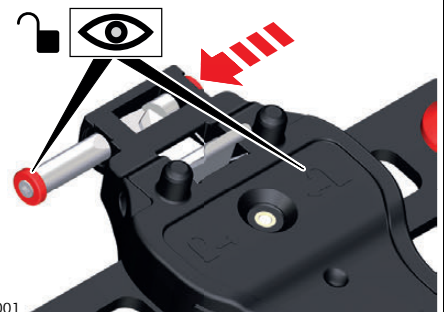

Step	Description
6.	Hold the CS field controller above the holder and lower the end of the CS field controller into the mounting plate.
7.	Apply slight pressure in a downward direction and then lower the top part of the CS field controller until the unit is clicked into the holder. The guides of the mounting plate aid in this action.
8.	After the CS field controller is placed onto the mounting plate, ensure that the locking pin is put into the locked position. To lock the locking pin, push the locking pin to the right.

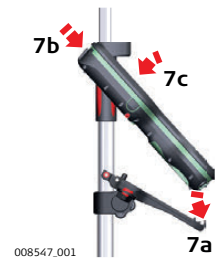

008547_001

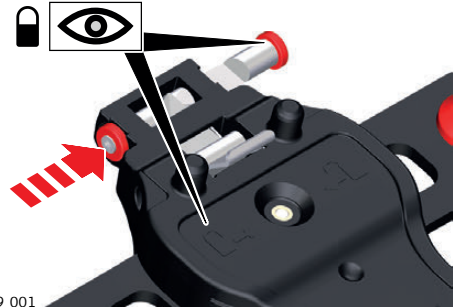

008549_001

Detaching the Field Controller from a Pole Step-by-step

Step	Description
1.	Unlock the locking pin by pushing the locking pin to the left of the mounting plate.
2.	Place your palm over the top of the field controller.
3.	While in this position, lift the top of the field controller from the holder.

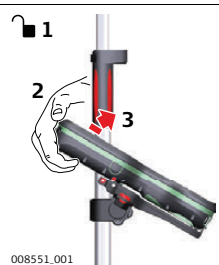

008551_001

Description

Windows Mobile Device Center for PCs with Windows 7/Windows 8/Windows 10 operating system is the synchronization software for Windows mobile-based pocket PCs. WMDC enables a PC and a Windows mobile-based pocket PC to communicate.

Leica USB drivers support Windows 7, Windows 8 (8.1) and Windows 10 operating systems.

Cables

Leica USB drivers support:





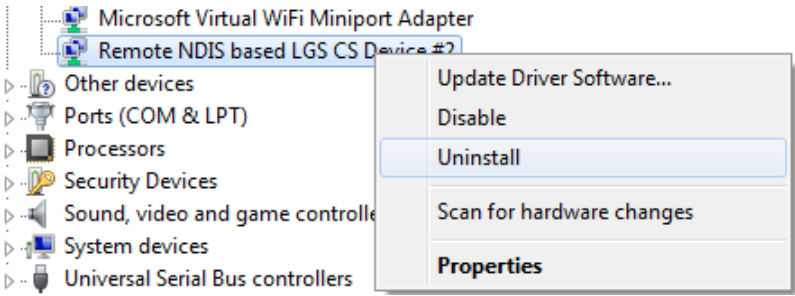
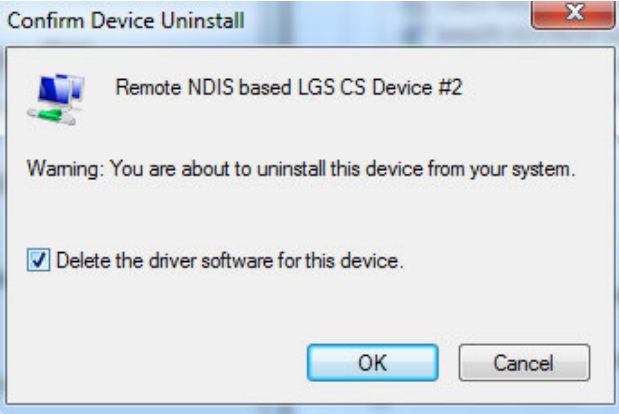

Name	Description
GEV223	USB data cable, 1.8 m, connects instrument to Mini-USB to USB
GEV234	USB data cable, 1.65 m, connects CS to GS or CS to PC (USB)
GEV261	Y-cable, 1.8 m, connects instrument to PC – battery

Uninstalling the previous drivers

 Skip the following steps if you have never installed Leica USB drivers before. If older drivers were previously installed on the PC, follow the instructions to un-install the drivers prior the installation of the new drivers.

Step	Description
1.	Connect your instrument to the PC via cable.
2.	On your PC, select to Control Panel > Device Manager .
3.	In Network Adapters , right-click on Remote NDIS based LGS....
4.	Click on Uninstall . 
5.	Set Delete the driver... as checked. Press OK . 

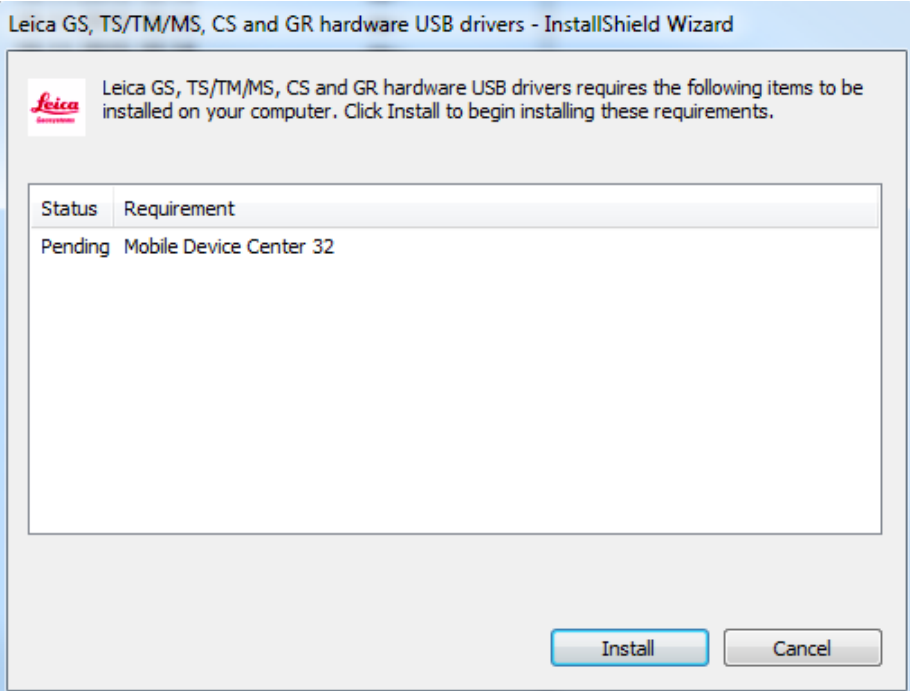
Install Leica USB drivers

Step	Description
1.	Start the PC.
2.	<p>Run the Setup_Leica_USB_XXbit.exe to install the drivers necessary for Leica devices. Depending on the version (32bit or 64bit) of the operating system on your PC, you have to select between the three setup files following:</p> <ul style="list-style-type: none"> • Setup_Leica_USB_32bit.exe • Setup_Leica_USB_64bit.exe • Setup_Leica_USB_64bit_itanium.exe <p> To check the version of your operating system, go to Control Panel > System > System type.</p> <p> The setup requires administrative privileges.</p> <p> The setup has to be run only once for all Leicadevices.</p> <p> For PCs with Windows Vista/Windows 7/Windows 8/Windows 10 operating system: If not already installed, WMDC will be installed additionally otherwise this panel would not appear. Click Install to continue or Cancel to exit installation.</p> 
3.	<p>The Welcome to InstallShield Wizard for Leica GS, TS/TM/MS, CS and GR USB drivers window appears.</p> <p> Ensure that all Leica devices are disconnected from your PC before you continue!</p>

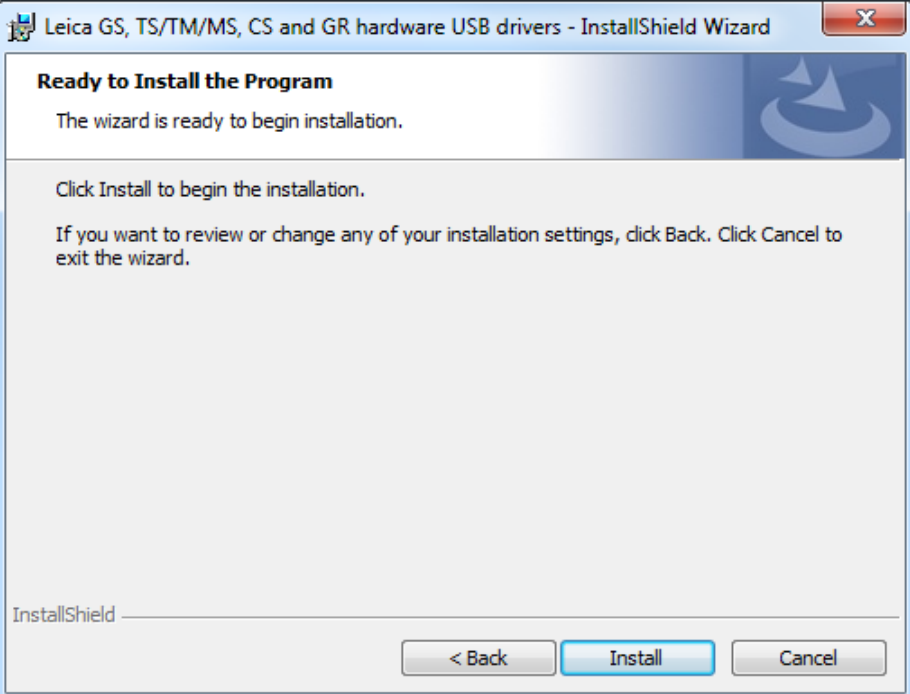
Step	Description
	
4.	Next> .
5.	<p>The Ready to Install the Program window appears.</p> 
6.	Install. The drivers will be installed on your PC.
7.	The InstallShield Wizard Completed window appears.
8.	Click Finish to exit the wizard.

Connect to PC via USB cable step-by-step

Step	Description
1.	Start the PC.
2.	Plug the cable into the instrument.
3.	Turn on the instrument.
4.	Plug the cable into the USB port of the PC.  Windows Device Manager cannot be used with CS20/TS16/TS60/MS60.
5.	Press the Windows Start button at the bottom left corner of the screen.
6.	Type the IP address of the device into the search field. <ul style="list-style-type: none"> • \\192.168.254.1\ for field controller • \\192.168.254.3\ for other instruments
7.	Press Enter . A file browser opens. You can now browse within the folders on the instrument.

4.1.6

Connecting to the Web Server

Description

The Web server is a web-based tool to view the status of and configure the GNSS instruments. The Web server application is integrated into the GS firmware and cannot be deleted.

Accessing the Web server via cable step-by-step

Step	Description
1.	Start the PC and turn on the GS GNSS instrument.  Instead of connecting to your PC, you can connect your GS GNSS instrument to the field controller.
2.	Connect the GS GNSS instrument with the GEV234 cable to the PC. Refer to "4.1.5 Connecting to a Personal Computer".
3.	Double-Click the Configure GS connection shortcut from the desktop of your PC. The GS GNSS network adapter is configured with IP address: 192.168.254.1. A DOS window appears when the configuration was successful. Press any key to exit the DOS window. The Configure GS connection shortcut disappears from the desktop.
4.	Start the web browser of your PC.
5.	Type in http://192.168.254.2 and press enter to access the web server of GS instrument.

Accessing the Web server via Bluetooth step-by-step

To access the Web server the tasks following have to be done:



- Configure the PC's Bluetooth device
- Establish a Bluetooth connection between PC and GS
- Accessing the Web server

Configuring the PC's Bluetooth device

Step	Description
1.	Start your PC.
2.	Activate the Bluetooth device of your PC.
3.	Go Start ⇒ Settings ⇒ Network Connections .
4.	Double-click Bluetooth from the LAN or High-Speed Internet device list. The Bluetooth Properties windows is started.

Step	Description
5.	In the General page, select Internet Protocol (TCP/IP) from the list and click Properties . The Internet Protocol (TCP/IP) properties windows is started.
6.	Set IP address: 192.168.253.1 and Subnet mask: 255.255.255.0 and click OK confirm the settings.
	This procedure has to be done only once.

Establishing a Bluetooth connection between PC and GS GNSS instrument

Step	Description
1.	Start the PC and turn on the GS GNSS instrument.  Instead of connecting to your PC, you can connect your GS GNSS instrument to the field controller. In this case, turn on the field controller, start Leica SmartWorx Viva/Leica Captivate and establish a Bluetooth connection to the GS GNSS instrument.
2.	Run the Bluetooth software and start the Bluetooth Setup Wizard .
3.	Click Next . The Bluetooth Device Selection will be started and an automatic search will be done.
4.	Select the shown GS GNSS instrument and click Next . The Bluetooth Security Setup is started.
5.	Type in 0000 as Bluetooth security code and click Pair Now . The pairing procedure will be done and the Bluetooth Service Selection is started.
6.	Highlight Personal Ad-hoc Network and check the checkbox for Personal Ad-hoc Network.  Do not select Serial Port as service.
7.	Click Next . The Bluetooth Setup Wizard Completion Page is started.
8.	Type in a name for your GS GNSS instrument and click Finish to complete the Bluetooth Setup Wizard .
	This procedure has to be repeated for every GS GNSS instrument you want to connect to.

Accessing the Web server

Step	Description
1.	Start the web browser on your PC/field controller.  Ensure that your GS GNSS instrument is still running and the Bluetooth connection between PC/field controller and GS is established.
2.	Type in 192.168.253.2 . The Web server is started. You will see the home functions following: <ul style="list-style-type: none"> • Go to Work! <ul style="list-style-type: none"> - To select and start the Wake-up application. • Current Status <ul style="list-style-type: none"> - To access GNSS information of the GS as well as the instrument firmware. • Instrument <ul style="list-style-type: none"> - To access configuration settings for the GS. • User <ul style="list-style-type: none"> - To upload and activate firmware, licence keys and languages.

4.2

Batteries

4.2.1

Operating Principles

First-time Use / Charging Batteries

- The battery must be charged prior to using it for the first time because it is delivered with an energy content as low as possible.
- The permissible temperature range for charging is between 0°C and +40°C/+32°F and +104°F. For optimal charging, we recommend charging the batteries at a low ambient temperature of +10°C to +20°C/+50°F to +68°F if possible.
- It is normal for the battery to become warm during charging. Using the chargers recommended by Leica Geosystems, it is not possible to charge the battery if the temperature is too high.
- For new batteries or batteries that have been stored for a long time (> three months), it is effectual to make only one charge/discharge cycle.
- For Li-Ion batteries, a single discharging and charging cycle is sufficient. We recommend carrying out the process when the battery capacity indicated on the charger or on a Leica Geosystems product deviates significantly from the actual battery capacity available.

Operation / Discharging

- The batteries can be operated from -20°C to +55°C/-4°F to +131°F.
- Low operating temperatures reduce the capacity that can be drawn; high operating temperatures reduce the service life of the battery.

4.2.2

Battery for GS14/GS16

Change Battery Step-by-step (GS14/GS16)



Step	Description
	The battery is inserted in the bottom part of the instrument.
1.	Push the slide fastener of the battery compartment in the direction of the arrow with the open-lock symbol.
2.	Remove the cover from the battery compartment.
3.	To remove the battery, push the battery slightly upwards and at the same time pull out the bottom part of the battery. This releases the battery from its fixed position.
4.	To insert the battery, slide the battery into the cover of the battery compartment with the battery contacts facing upwards. Push the battery downwards so that it locks into position.
5.	Insert the cover of the battery compartment into the compartment.
6.	Push the slide fastener in the direction of the arrow with the close-lock symbol.

4.3

Working with the Memory Device



- Keep the card dry.
- Use it only within the specified temperature range.
- Do not bend the card.
- Protect the card from direct impacts.



Failure to follow these instructions could result in data loss and/or permanent damage to the card.

Insert a microSD card into GS14/GS16 step-by-step

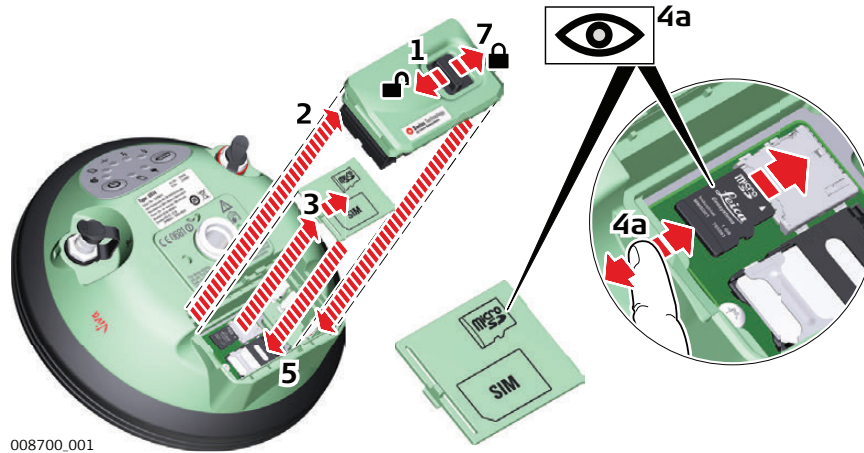

008700_001

Step	Description
	Removing the microSD card while the GS14/GS16 is turned on can cause loss of data. Only remove the microSD card or unplug connecting cables when the GS14/GS16 is switched off.
	The microSD card is inserted into a slot inside the battery compartment of the instrument.
1.	Push the slide fastener of the battery compartment in the direction of the arrow with the open-lock symbol.
2.	Remove the cover from the battery compartment.
3.	Press the latch of the SIM/microSD card cover and remove the cover.
4.	Slide the microSD card with the logo facing upwards firmly into the slot until it clicks into position.
5.	Insert the SIM/microSD card cover to cover slot.
6.	Insert the cover over the battery compartment.
7.	Push the slide fastener in the direction of the arrow with the close-lock symbol.

4.4

Working with the RTK Device

Devices Fitted into the GS14/GS16 GNSS Instrument

Depending on the GS14/GS16 model one or two of the following devices are integrated:

Type	Device
2G GSM	Cinterion BGS2-W
3.75G GSM/UMTS	Cinterion PHS8-P/PHS8-J
3.75G GSM/UMTS	Cinterion PXS8
RX UHF radio	Satel OEM20, receive
RX/TX UHF radio	Satel OEM22, receive/transmit
RX/TX UHF radio	Satel M3-TR4, receive/transmit

Insert and Remove a SIM Card Step-by-Step

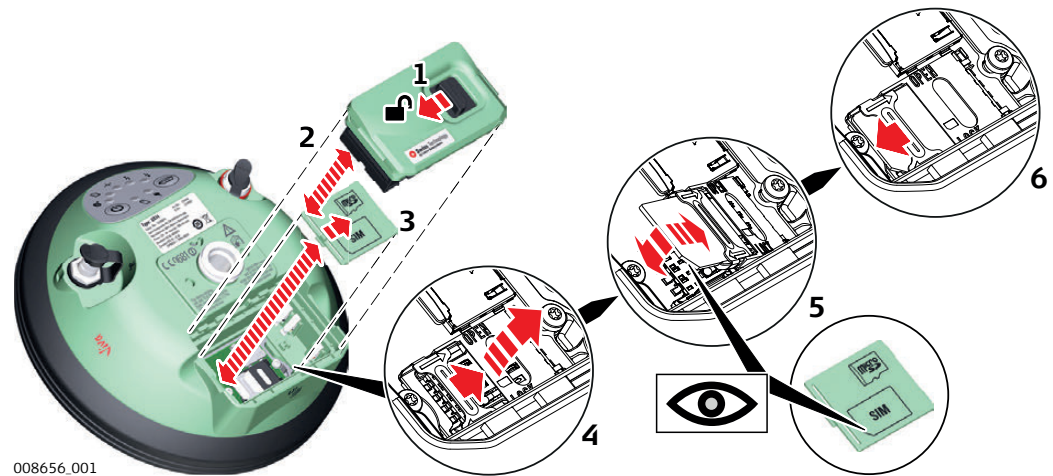

008656.001

Step	Description
	Inserting/removing the SIM card while the GS14/GS16 is turned on can result in permanent damage to the card. Only insert/remove the SIM card when the GS14/GS16 is switched off.
	The SIM card is inserted into a slot inside the battery compartment.
1.	Push the slide fastener of the battery compartment in the direction of the arrow with the open-lock symbol.
2.	Remove the cover from battery compartment.
3.	Press the latch of the SIM/microSD card cover and remove the cover.
4.	Push the SIM card holder in the direction of the OPEN arrow and flip it up.
5.	Place the SIM card into the SIM card holder, the chip facing the connectors inside the slot - as shown on the SIM/microSD card cover. Press the SIM card holder down.
6.	Push the SIM card holder in the direction of the LOCK arrow to close.

LED Indicators

Description

The GS14/GS16 GNSS instrument has Light Emitting Diode indicators. They indicate the basic instrument status.

Diagram

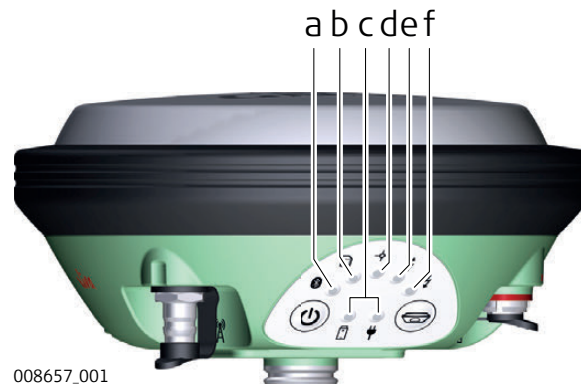

- a) Bluetooth LED
- b) Storage LED
- c) Power LEDs
- d) Position LED
- e) RTK Base LED
- f) RTK Rover LED

Description of the LEDs

IF the	is	THEN
Bluetooth LED	green	Bluetooth is in data mode and ready for connecting.
	blue	Bluetooth has connected.
Storage LED	off	no microSD card is inserted or GS14/GS16 is switched off.
	green	microSD card is inserted but no raw data is being logged.
	flashing green	raw data is being logged.
	flashing red	raw data is being logged but only 5% memory left.
	red	microSD card is full, no raw data is being logged or no microSD card is inserted but GS14/GS16 is configured to log raw data.
Position LED	off	no satellites are tracked or GS14/GS16 is switched off.
	flashing yellow	less than four satellites are tracked, a position is not yet available.
	yellow	a navigated position is available.
	flashing green	a code-only position is available.
	green	a fixed RTK position is available. SmartLink is converging or has converged.
Power LED (active battery* ¹)	off	battery is not connected, flat or GS14/GS16 is switched off.
	green	power is 20% - 100%.
	red	power is 5% - 20%. The remaining time for which enough power is available depends on the type of survey, the temperature and the age of the battery.
	fast flashing red	power is low (< 5%).

IF the	is	THEN
Power LED (passive battery ^{*2})	off	battery is not connected, flat or the GS14/GS16 is switched off.
	flashing green	power is 20% - 100%. LED is green for 1 s every 10 s.
	flashing red	power is less than 20%. LED is red for 1 s every 10 s.
RTK Rover LED	off	GS14/GS16 is in RTK base mode or GS14/GS16 is switched off.
	green	GS14/GS16 is in rover mode. No RTK data is being received at the interface of the communication device.
	flashing green	GS14/GS16 is in rover mode. RTK data is being received at the interface of the communication device.
RTK Base LED	off	GS14/GS16 is in RTK rover mode or GS14/GS16 is switched off.
	green	GS14/GS16 is in RTK base mode. No RTK data is being passed to the interface of the communication device.
	flashing green	GS14/GS16 is in RTK base mode. Data is being passed to the interface of the communication device.

*1 The battery, which currently powers the GS14/GS16 instrument.

*2 Other batteries, which are inserted or connected but are not currently powering the GS14/GS16 instrument.

4.6

Guidelines for Correct Results with GNSS Surveys

Undisturbed satellite signal reception

Successful GNSS surveys require undisturbed satellite signal reception, especially at the instrument which serves as a base. Set up the instrument in locations which are free of obstructions such as trees, buildings or mountains.

Steady instrument for static surveys

For static surveys, the instrument must be kept perfectly steady throughout the whole occupation of a point. Place the instrument on a tripod or pillar.

Centred and levelled instrument

Centre and level the instrument precisely over the marker.

5 Care and Transport

5.1 Transport

Transport in the field	<p>When transporting the equipment in the field, always make sure that you</p> <ul style="list-style-type: none">• either carry the product in its original transport container,• or carry the tripod with its legs splayed across your shoulder, keeping the attached product upright.
Transport in a road vehicle	<p>Never carry the product loose in a road vehicle, as it can be affected by shock and vibration. Always carry the product in its transport container, original packaging or equivalent and secure it.</p>
Shipping	<p>When transporting the product by rail, air or sea, always use the complete original Leica Geosystems packaging, transport container and cardboard box, or its equivalent, to protect against shock and vibration.</p>
Shipping, transport of batteries	<p>When transporting or shipping batteries, the person responsible for the product must ensure that the applicable national and international rules and regulations are observed. Before transportation or shipping, contact your local passenger or freight transport company.</p>

5.2 Storage

Product	<p>Respect the temperature limits when storing the equipment, particularly in summer if the equipment is inside a vehicle. Refer to "6 Technical Data" for information about temperature limits.</p>
Li-Ion batteries	<ul style="list-style-type: none">• Refer to "Technical Data" for information about storage temperature range.• Remove batteries from the product and the charger before storing.• After storage recharge batteries before using.• Protect batteries from damp and wetness. Wet or damp batteries must be dried before storing or use.• A storage temperature range of 0°C to +30°C / +32°F to +86°F in a dry environment is recommended to minimize self-discharging of the battery.• At the recommended storage temperature range, batteries containing a 40% to 50% charge can be stored for up to one year. After this storage period the batteries must be recharged.

5.3

Cleaning and Drying

Product and accessories

- Use only a clean, soft, lint-free cloth for cleaning. If necessary, moisten the cloth with water or pure alcohol. Do not use other liquids; these may attack the polymer components.
-

Damp products

Dry the product, the transport container, the foam inserts and the accessories at a temperature not greater than 40 °C [104 °F] and clean them. Remove the battery cover and dry the battery compartment. Do not repack until everything is dry. Always close the transport container when using in the field.

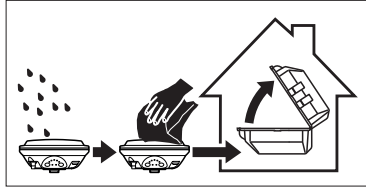

Cables and plugs

Keep plugs clean and dry. Blow away any dirt lodged in the plugs of the connecting cables.

Connectors with dust caps

Wet connectors must be dry before attaching the dust cap.

6 Technical Data

6.1 GS14/GS16 Technical Data

6.1.1 Tracking Characteristics GS14

Satellite reception Dual frequency

Supported signals

System	Signal
GPS	L1 C/A, L2P, L2C
GLONASS	L1 C/A, L2P, L2C
Galileo	E1, E5b
BeiDou	B1, B2



Carrier phase and code measurements on L1 and L2 are fully independent with AS on or off.

6.1.2 Tracking Characteristics GS16

Satellite reception Multi-frequency

Instrument channels



Depending on the satellite systems and signals configured, a maximum number of 555 channels is allocated.

Supported signals

System	Signal
GPS	L1 C/A, L2P, L2C, L5
GLONASS	L1 C/A, L2P, L2C
Galileo	E1, E5a, E5b, AltBOC
BeiDou	B1, B2



Carrier phase and code measurements on L1, L2 and L5 (GPS) are fully independent with AS on or off.



Support of QZSS L1, L2S, L5Q, L6L and IRNSS L5A is incorporated and will be provided through future firmware upgrade.

6.1.3

Accuracy



Accuracy is dependent upon various factors including the number of satellites tracked, constellation geometry, observation time, ephemeris accuracy, ionospheric disturbance, multipath and resolved ambiguities.

The following accuracies, given as **root mean square**, are based on measurements processed using Infinity and on real-time measurements.

The use of multiple GNSS systems can increase accuracy by up to 30% relative to GPS only.

Differential code

The baseline precision of a differential code solution for static and kinematic surveys is 25 cm.

Differential phase in post-processing

Type	Horizontal	Vertical
Static and rapid static	3 mm + 0.5 ppm	5 mm + 0.5 ppm
Kinematic	8 mm + 1 ppm	15 mm + 1 ppm
Static with long observations	3 mm + 0.1 ppm	3.5 mm + 0.4 ppm

Differential phase in real-time

Type	Horizontal	Vertical
Single Baseline (< 30 km)	8 mm + 1 ppm	15 mm + 1 ppm
Network RTK	8 mm + 0.5 ppm	15 mm + 0.5 ppm

6.1.4

Technical Data

Dimensions

Height: 0.090 m
Diameter: 0.190 m

Weight

Instrument weight without battery, SIM card and SD card:

Type	Weight [kg]/[lbs]
GS14/GS16	0.93/2.04

Recording

Data (Leica GNSS raw data and RINEX data) can be recorded on the SD card. 1 GB is sufficient for over 1 year of raw data logging based on logging every 15 s from an average of 15 satellites.

Power

Power consumption: GS14, radio excluded: 2.6 W typically, 220 mA (with external battery), 350 mA (with internal battery)
GS16, radio excluded: 3.1 W typically, 260 mA (with external battery), 420 mA (with internal battery)

External supply voltage: Nominal 12 V DC (---, GEV71 car battery cable to a 12 V car battery), voltage range 10.5 V-28 V DC

Internal battery	Type:	Li-Ion
	Voltage:	7.4 V
	Capacity:	GEB212: 2.6 Ah

External battery	GEB371	
	Type:	Li-Ion
	Voltage:	13 V
	Capacity:	16.8 Ah

Operating times The given operating times are valid for

- GS14/GS16: instrument; one fully charged GEB212 battery.
- room temperature. Operating times will be shorter when working in cold weather.

Equipment			Operating time
Type	Radio	Digital cellular phone	
Static	-	-	10 h continuously
Rover	Satel OEM20, receive	-	7 h continuously
	Satel OEM22, receive	-	
	Satel M3-TR4, receive	-	7 h continuously
	-	Cinterion BGS2-W	6 h continuously
Base	Satel OEM22, transmit	-	5 h continuously
	Satel M3-TR4, transmit	-	5 h continuously
	-	Cinterion BGS2-W	6 h continuously
		Cinterion PHS8-P/PHS8-J Cinterion PXS8	

Electrical data

Type	GS14	GS16
Voltage	-	-
Current	-	-
Frequency		
GPS L1 1575.42 MHz	✓	✓
GPS L2 1227.60 MHz	✓	✓
GPS L5 1176.45 MHz	-	✓
GLONASS L1 1602.5625-1611.5 MHz	✓	✓
GLONASS L2 1246.4375-1254.3 MHz	✓	✓
Galileo E1 1575.42 MHz	✓	✓
Galileo E5a 1176.45 MHz	-	✓
Galileo E5b 1207.14 MHz	-	✓
Galileo AltBOC 1191.795 MHz	-	✓
BeiDou B1 1561.098 MHz	✓	✓
BeiDou B2 1207.14 MHz	✓	✓
Gain (LNA)	Typically 22 dB	Typically 22 dB
Noise Figure	Typically < 2 dB	Typically < 2 dB

Environmental specifications

Temperature

Type	Operating temperature [°C]	Storage temperature [°C]
Instrument	-40 to +65	-40 to +80
Leica SD cards	-40 to +85	-40 to +100
GEB212	-20 to +55	-40 to +70

Protection against water, dust and sand

Protection
IP68 (IEC 60529) Dust tight Protected against continuous immersion in water Tested for 2 hours in 1.40 m depth

Humidity

Protection
Up to 100 % The effects of condensation are to be effectively counteracted by periodically drying out the instrument.

6.2

Conformity to National Regulations

6.2.1

GS14/GS16

Conformity to national regulations

- FCC Part 15 (applicable in US)
- Hereby, Leica Geosystems AG, declares that the product GS14/GS16 is in compliance with the essential requirements and other relevant provisions of Directive 1999/5/EC and other applicable European Directives. The declaration of conformity can be consulted at <http://www.leica-geosystems.com/ce>.



Class 2 equipment according European Directive 1999/5/EC (R&TTE)

- The conformity for countries with other national regulations not covered by the FCC part 15 or European directive 1999/5/EC has to be approved prior to use and operation.
- Japanese Radio Law and Japanese Telecommunications Business Law Compliance (applicable for Japan).
 - This device is granted pursuant to the Japanese Radio Law and the Japanese Telecommunications Business Law.
 - This device should not be modified (otherwise the granted designation number will become invalid).

Frequency band

Type	Frequency band [MHz]
GS14/GS16	1227.60 1246.4375 - 1254.3 1575.42 1602.5625 - 1611.5
GS14/GS16, Bluetooth	2402 - 2480
GS14/GS16, Radio	403 - 473
GS14/GS16, 2G GSM	Quad-Band EGSM 850 / 900 / 1800 / 1900
GS14/GS16, 3.75G GSM/UMTS	Quad-Band GSM & Penta-Band UMTS 800 / 850 / 900 / 1900 / 2100
GS14/GS16, 3.75G GSM/UMTS/CDMA	Quad-Band GSM & Penta-Band UMTS & Tri-Band CDMA 800 / 1900

Output power

Type	Output power [mW]
GNSS	Receive only
Bluetooth	5
Radio	1000
2G GSM EGSM850/900	2000
2G GSM GSM1800/1900	1000
2G GSM	GPRS multi-slot class 10 (max. 2/8 TX)
3.75G GSM	E(dge)GPRS multi-slot class 12 (max. 4/8 TX)
3.75G UMTS 800/850/900/1900/2100	250
CDMA BC0 & BC10 (800)/BC1 (1900)	250

Antenna

Type	Antenna	Gain [dBi]
GNSS	Internal GNSS antenna element (receive only)	-
Bluetooth	Internal Microstrip antenna	2 max.
UHF	External antenna	-
GSM/UMTS/CDMA	Integrated antenna	0 max. @ 800 / 850 / 900 3 max. @ 1800 / 1900 / 2100



6.2.2

Dangerous Goods Regulations

Dangerous Goods Regulations

The products of Leica Geosystems are powered by Lithium batteries.

Lithium batteries can be dangerous under certain conditions and can pose a safety hazard. In certain conditions, Lithium batteries can overheat and ignite.

-  When carrying or shipping your Leica product with Lithium batteries onboard a commercial aircraft, you must do so in accordance with the **IATA Dangerous Goods Regulations**.
-  Leica Geosystems has developed **Guidelines** on "How to carry Leica products" and "How to ship Leica products" with Lithium batteries. Before any transportation of a Leica product, we ask you to consult these guidelines on our web page (<http://www.leica-geosystems.com/dgr>) to ensure that you are in accordance with the IATA Dangerous Goods Regulations and that the Leica products can be transported correctly.
-  Damaged or defective batteries are prohibited from being carried or transported onboard any aircraft. Therefore, ensure that the condition of any battery is safe for transportation.

Software Licence Agreement

This product contains software that is preinstalled on the product, or that is supplied to you on a data carrier medium, or that can be downloaded by you online according to prior authorisation from Leica Geosystems. Such software is protected by copyright and other laws and its use is defined and regulated by the Leica Geosystems Software Licence Agreement, which covers aspects such as, but not limited to, Scope of the Licence, Warranty, Intellectual Property Rights, Limitation of Liability, Exclusion of other Assurances, Governing Law and Place of Jurisdiction. Please make sure, that at any time you fully comply with the terms and conditions of the Leica Geosystems Software Licence Agreement.

Such agreement is provided together with all products and can also be referred to and downloaded at the Leica Geosystems home page at <http://leica-geosystems.com/about-us/compliance-standards/legal-documents> or collected from your Leica Geosystems distributor.

You must not install or use the software unless you have read and accepted the terms and conditions of the Leica Geosystems Software Licence Agreement. Installation or use of the software or any part thereof, is deemed to be an acceptance of all the terms and conditions of such Licence Agreement. If you do not agree to all or some of the terms of such Licence Agreement, you must not download, install or use the software and you must return the unused software together with its accompanying documentation and the purchase receipt to the distributor from whom you purchased the product within ten (10) days of purchase to obtain a full refund of the purchase price.

Appendix A Pin Assignments and Sockets

Description

Some applications require knowledge of the pin assignments for the instrument ports. In this chapter, the pin assignments and sockets for the instrument ports are explained.

Ports at the instrument underside

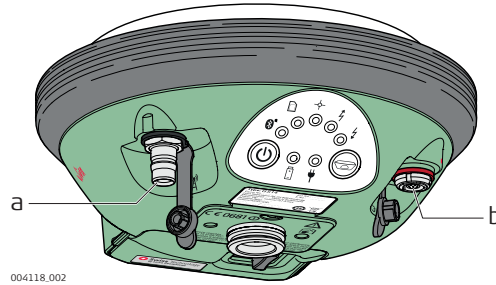

- a) QN-connector, only for models with UHF radio
- b) Port 1 (USB and serial)

Pin assignments for port P1

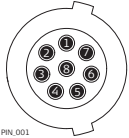

Pin	Signal Name	Function	Direction
1	USB_D+	USB data line	In or out
2	USB_D-	USB data line	In or out
3	GND	Signal ground	-
4	RxD	RS232, receive data	In
5	TxD	RS232, transmit data	Out
6	ID	Identification pin	In or out
7	PWR	Power input, 10.5 V-28 V	In
8	GPIO	RS232, general-purpose signal	In or out

798165-4.0.1en

Original text

Published in Switzerland

© 2016 Leica Geosystems AG, Heerbrugg, Switzerland

Leica Geosystems AG

Heinrich-Wild-Strasse

CH-9435 Heerbrugg

Switzerland

Phone +41 71 727 31 31

www.leica-geosystems.com

- when it has to be **right**

Leica
Geosystems